

ALUMINIUM PROFILE
(Alüminyum Profil)

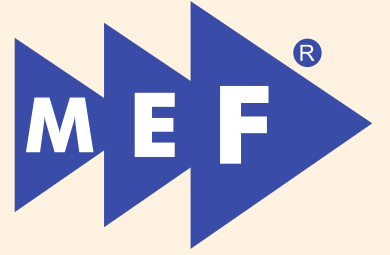

İstanbul/TÜRKİYE



info@mefmetal.com.tr



+90 216 388 74 56



www.mefmetal.com.tr



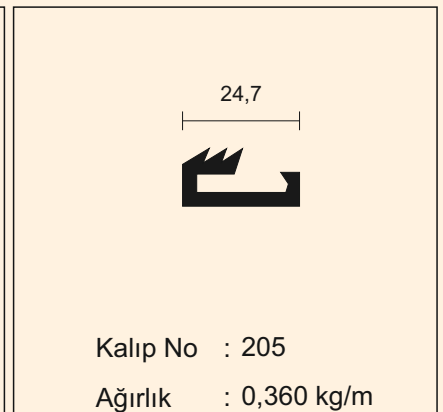
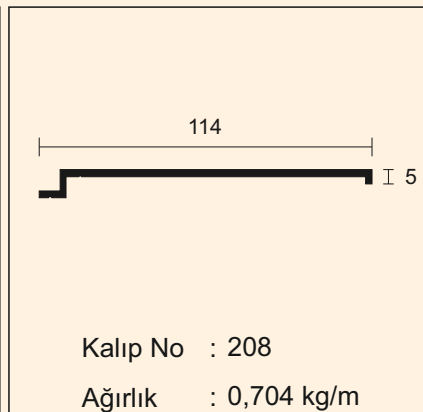
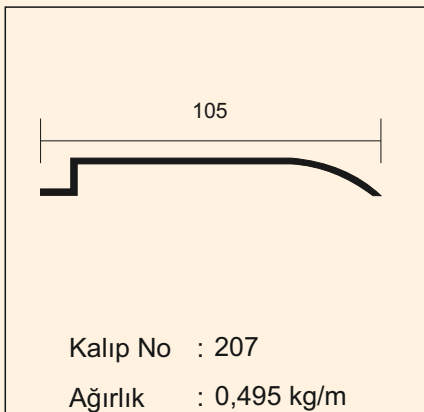
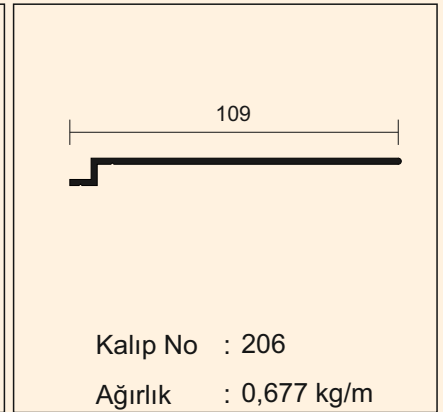
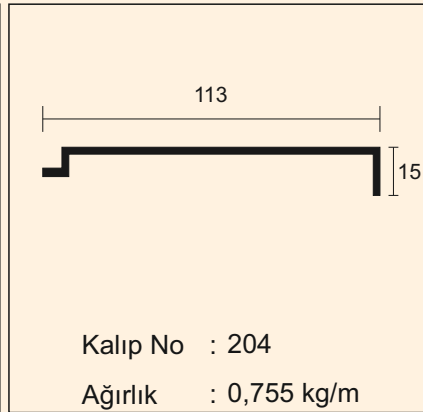
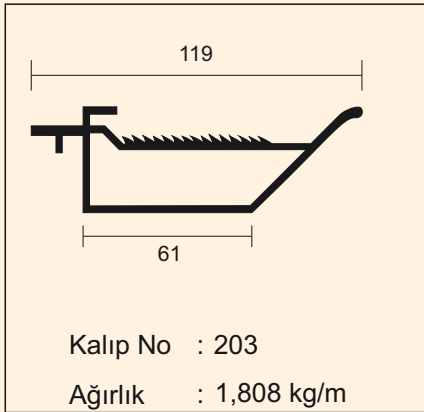
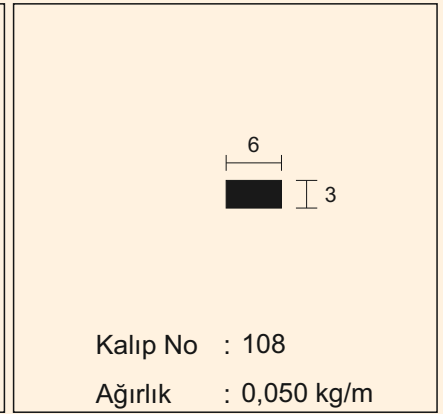
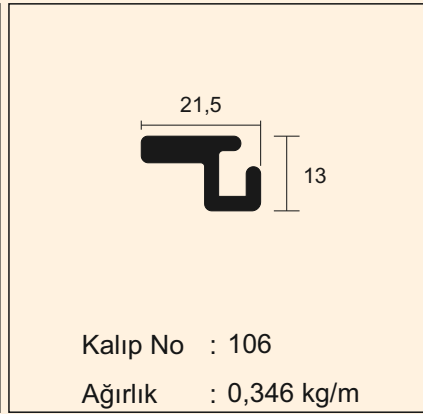
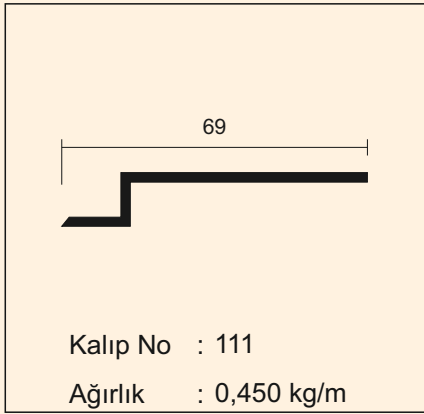
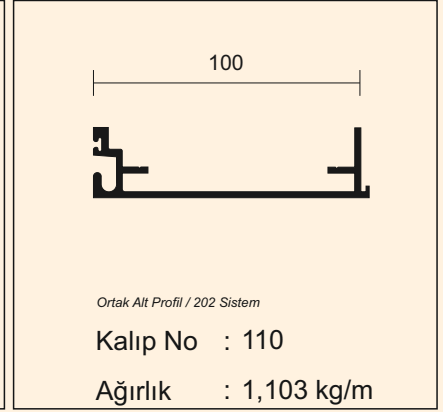
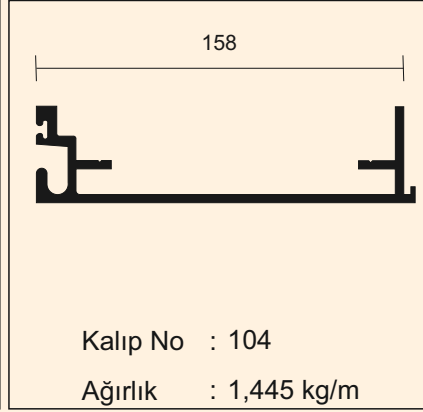
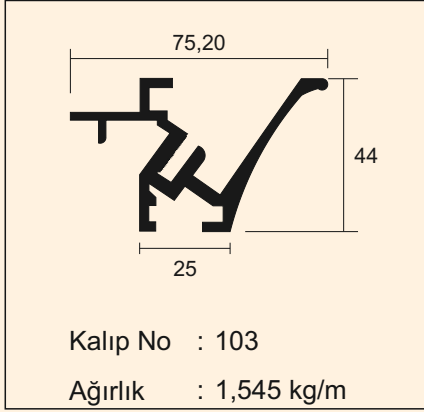

Katalogumuzda bulunan profil çizimleri örnek olarak konulmuştur. Müşterilerimize ait olan çizimlerin profilleri satılamaz. Çizimler üzerinden ölçü almayınız. Resimlerin altında yer alan profil ağırlığı bilgi amaçlı olup, ürünlerin teslim anındaki tartımız ağırlığı geçerlidir.

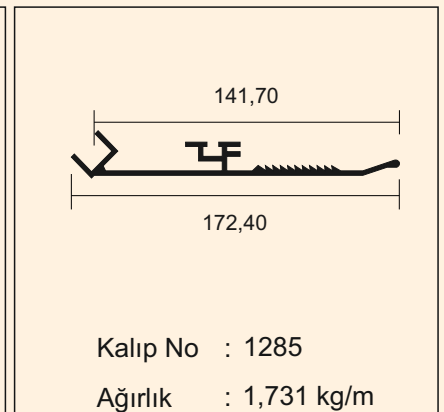
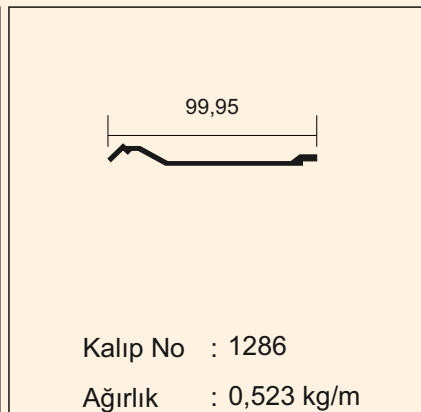
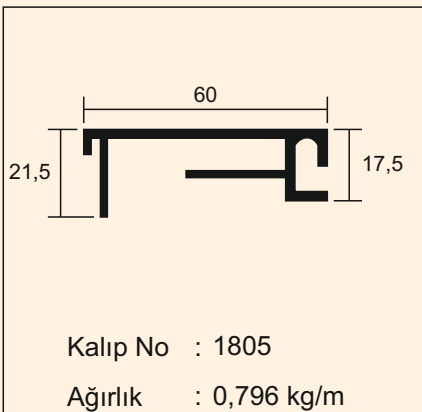
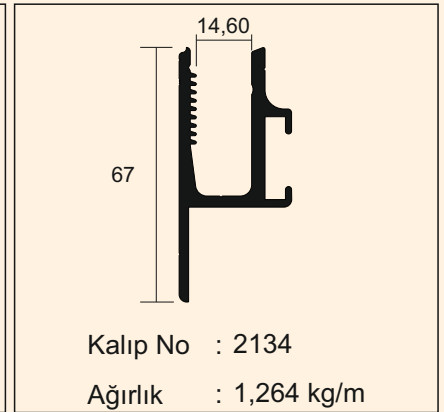
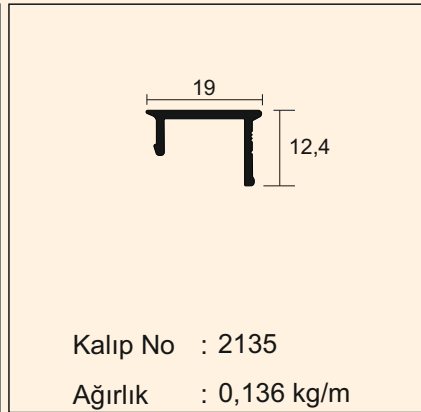
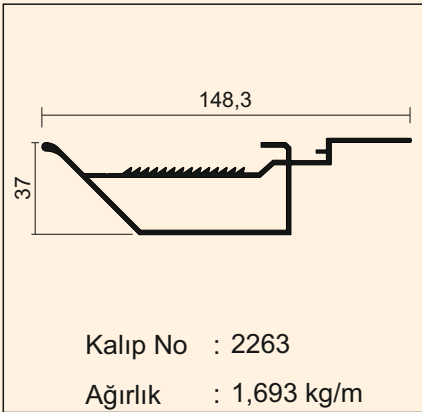
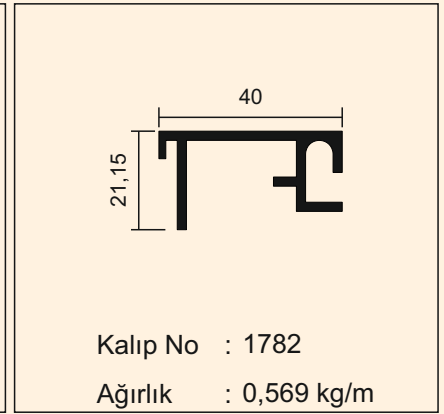
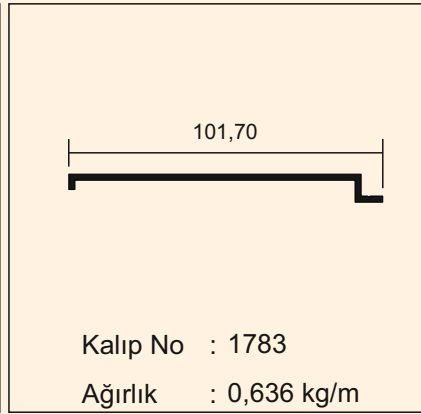
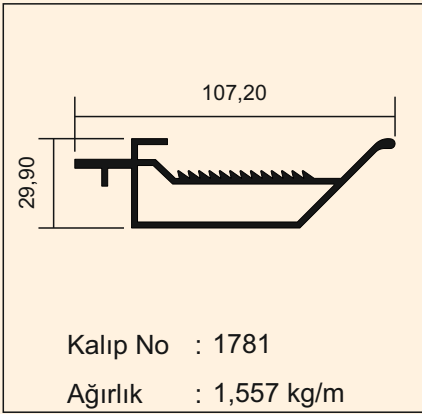
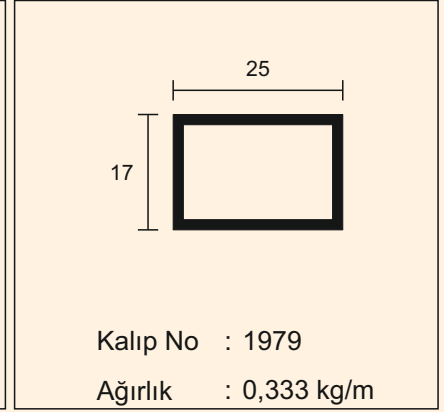
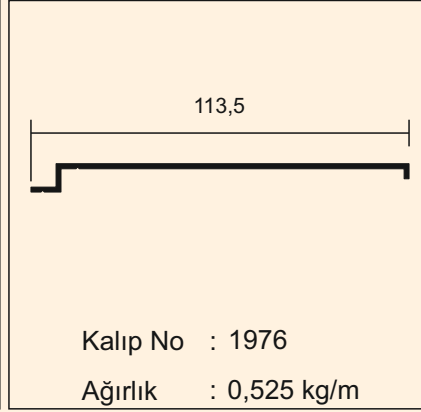
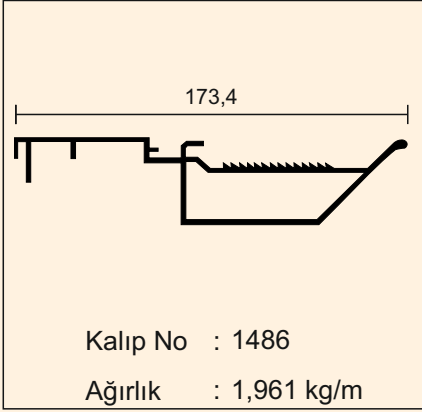

Kataloğumuzda bulunan profil çizimleri örnek olarak konulmuştur. Müşterilerimize ait olan çizimlerin profilleri satılamaz. Çizimler üzerinden ölçü almayınız. Resimlerin altında yer alan profil ağırlığı bilgi amaçlı olup, ürünlerin teslim anındaki tartımız ağırlığı geçerlidir.

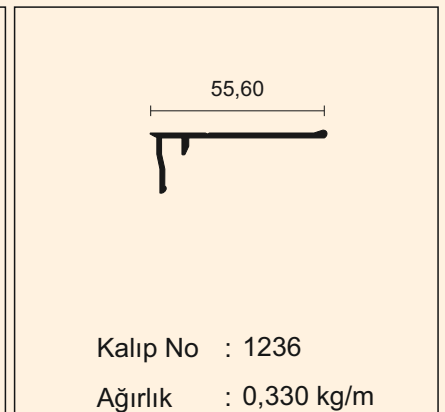
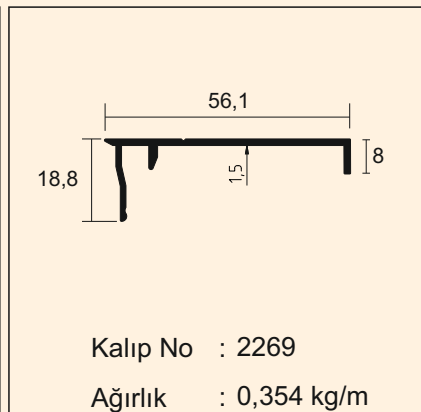
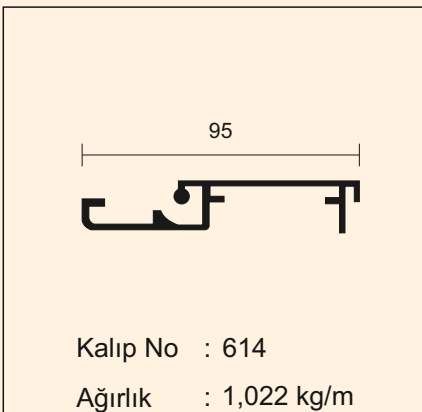
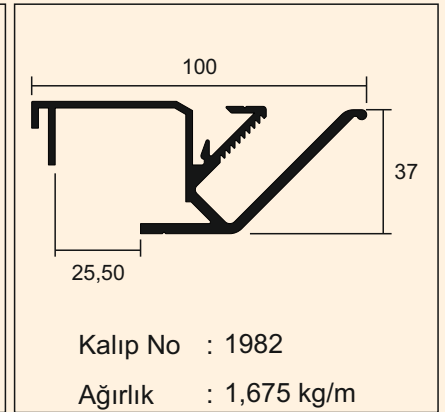
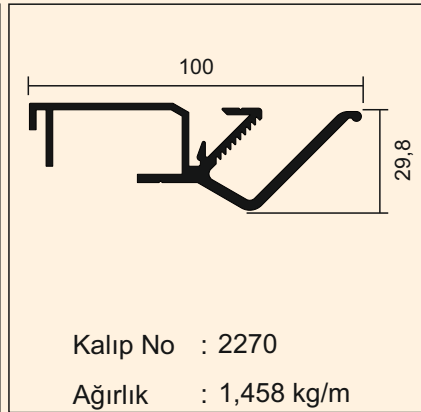
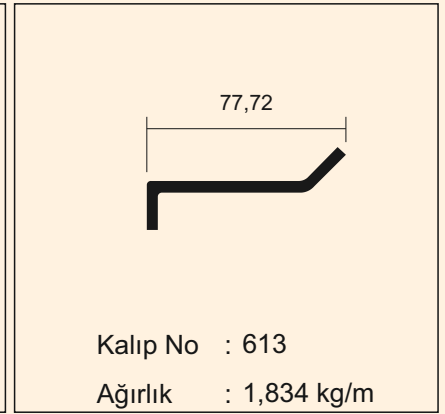
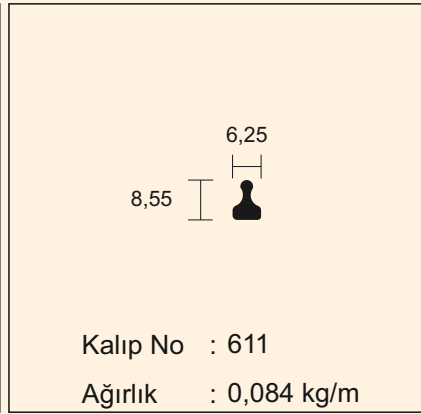
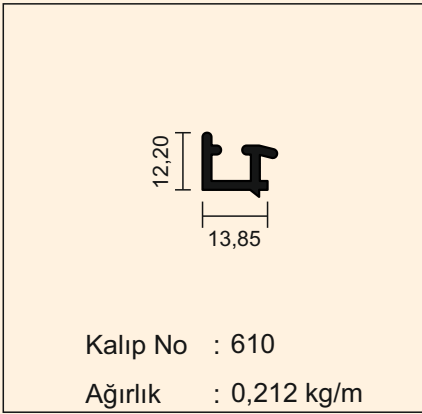
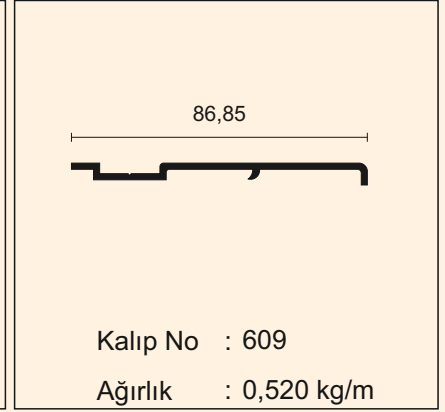
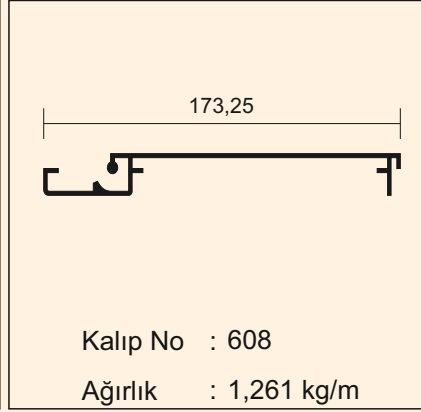
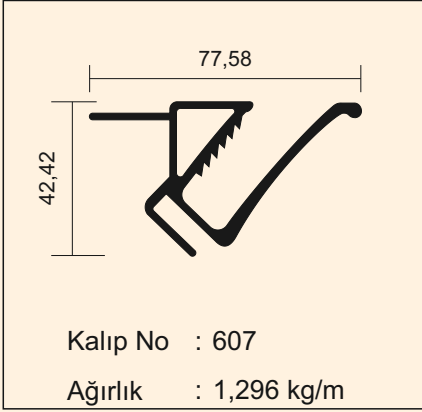

Katalogumuzda bulunan profil çizimleri örnek olarak konulmuştur. Müşterilerimize ait olan çizimlerin profilleri satılamaz. Çizimler üzerinden ölçü almayınız. Resimlerin altında yer alan profil ağırlığı bilgi amaçlı olup, ürünlerin teslim anındaki tartımız ağırlığı geçerlidir.

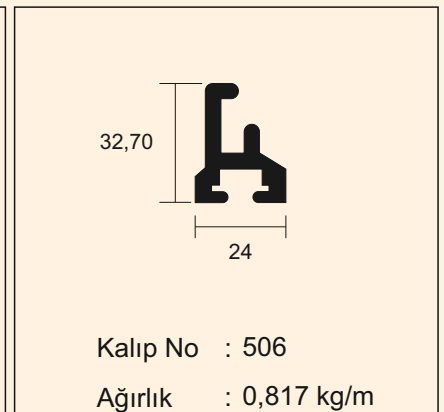
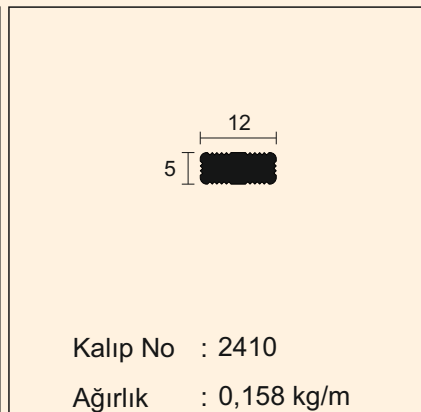
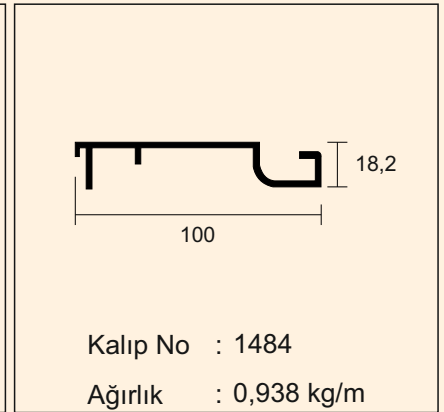
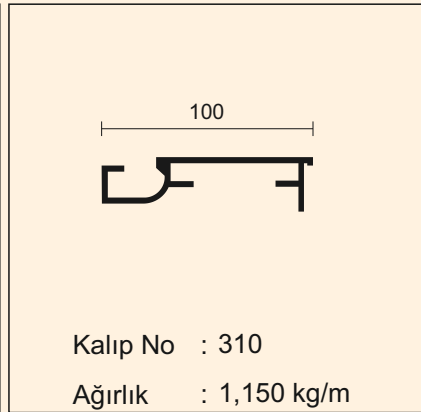
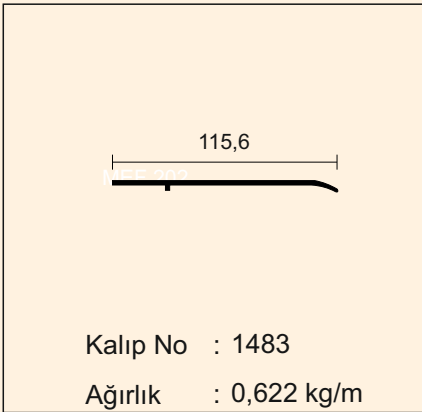
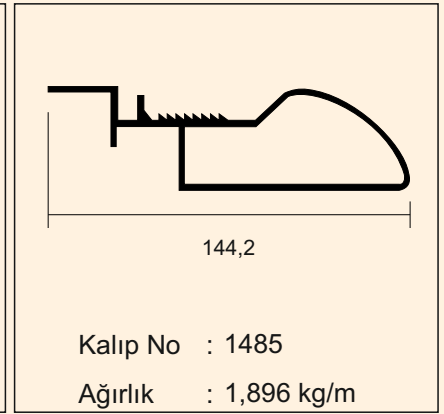
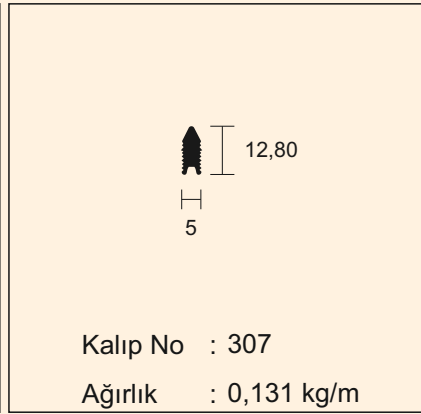
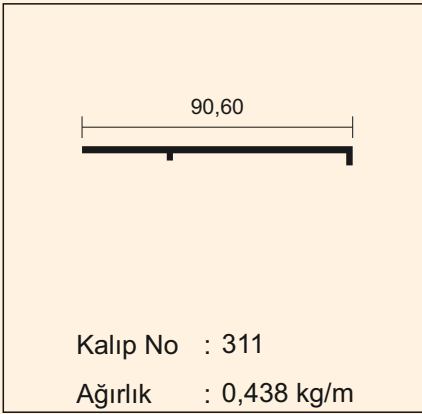
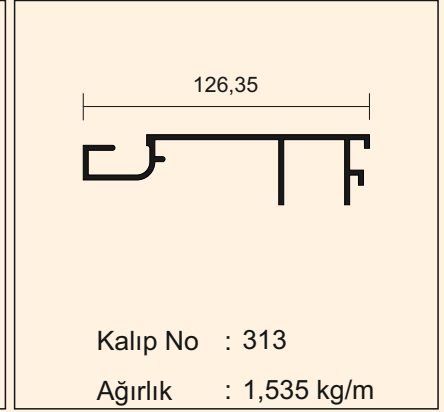
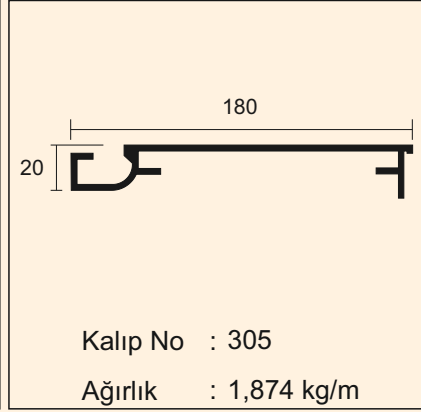
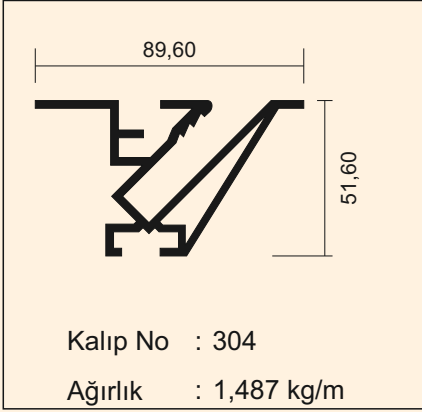

Kataloğumuzda bulunan profil çizimleri örnek olarak konulmuştur. Müşterilerimize ait olan çizimlerin profilleri satılamaz. Çizimler üzerinden ölçü almayınız. Resimlerin altında yer alan profil ağırlığı bilgi amaçlı olup, ürünlerin teslim anındaki tartımız ağırlığı geçerlidir.

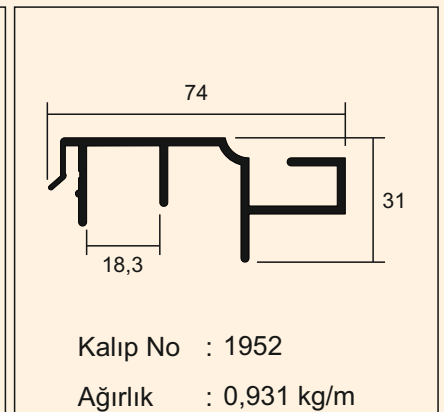
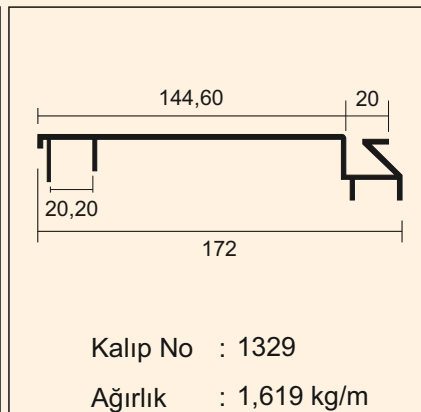
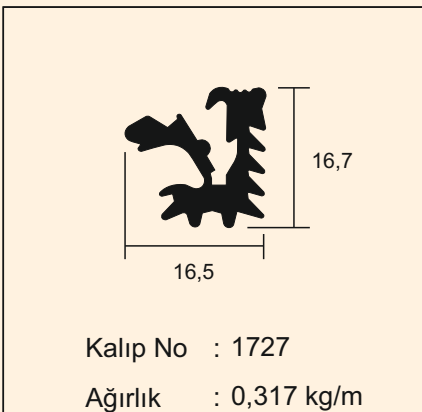
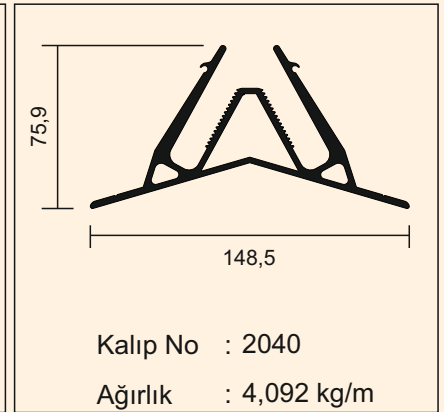
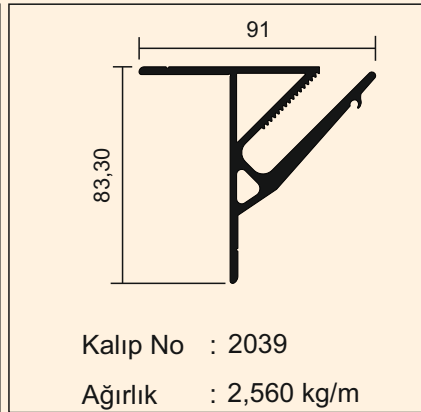
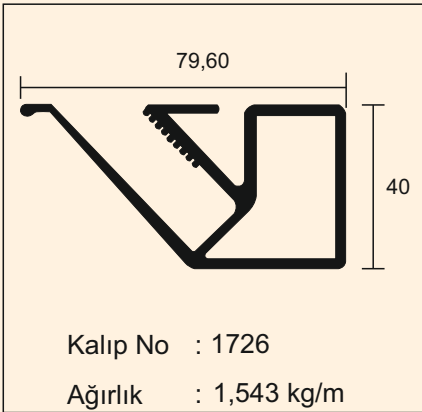
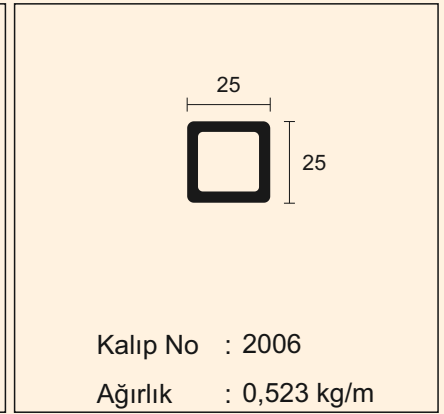
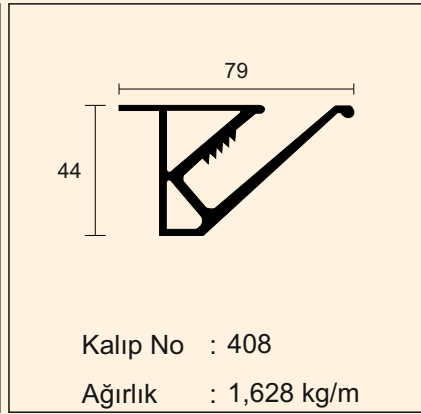
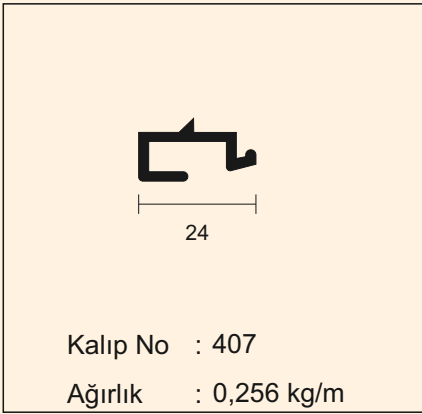
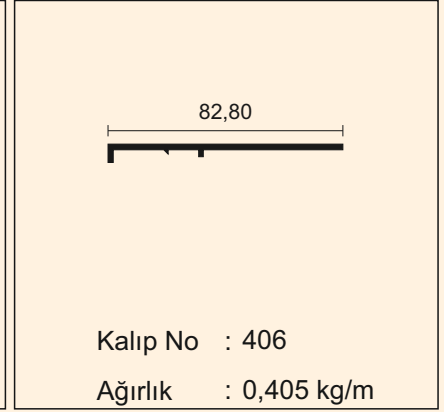
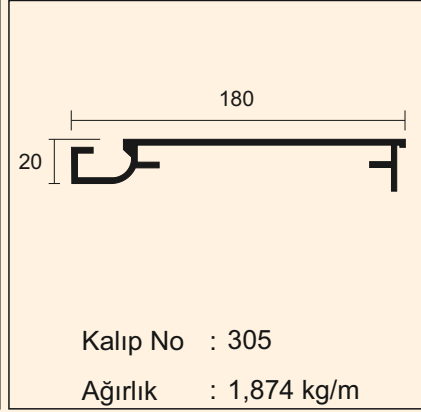
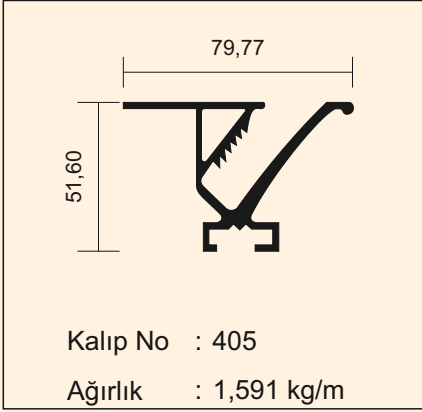

Kataloğumuzda bulunan profil çizimleri örnek olarak konulmuştur. Müşterilerimize ait olan çizimlerin profilleri satılamaz. Çizimler üzerinden ölçü almayınız. Resimlerin altında yer alan profil ağırlığı bilgi amaçlı olup, ürünlerin teslim anındaki tartımız ağırlığı geçerlidir.

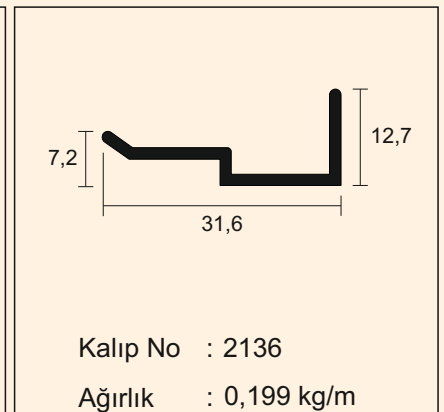
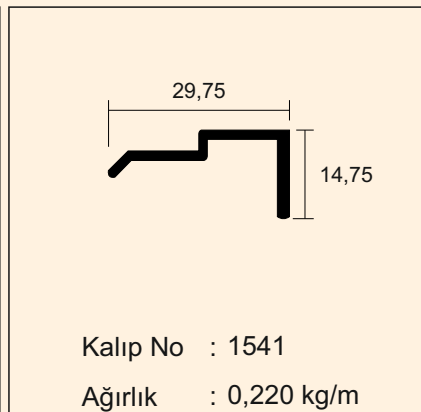
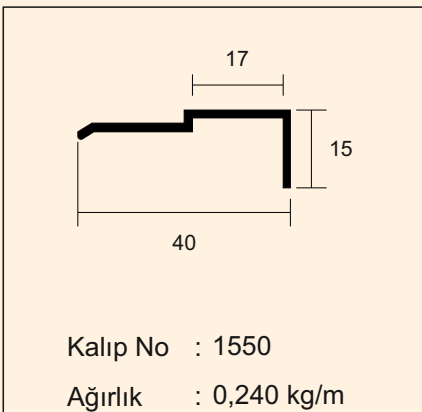
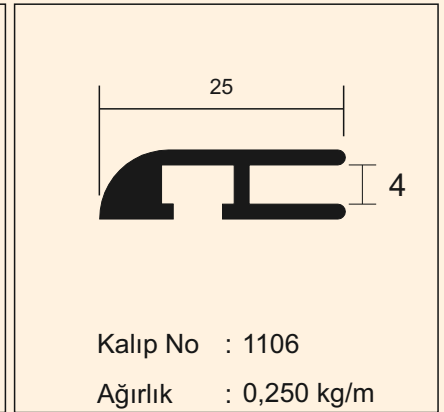
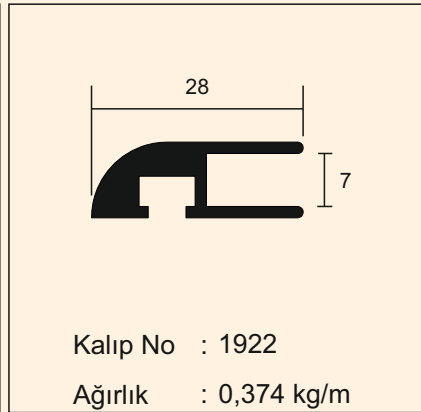
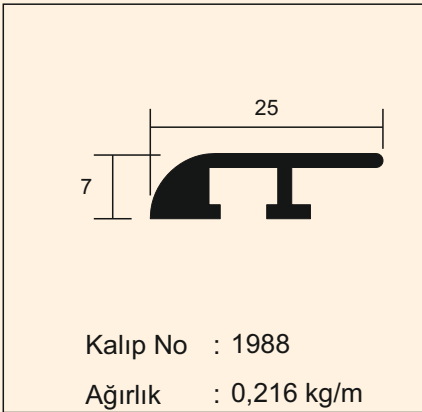
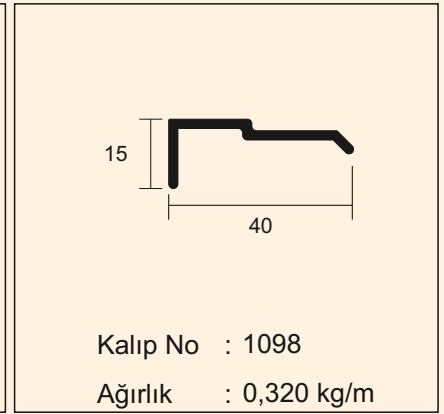
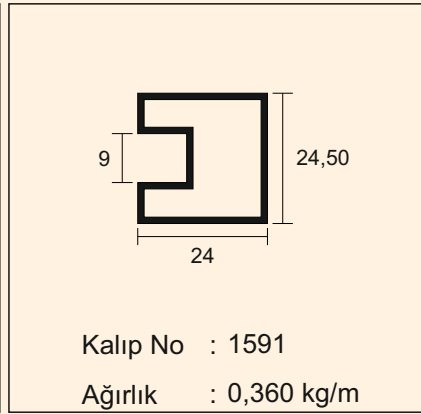
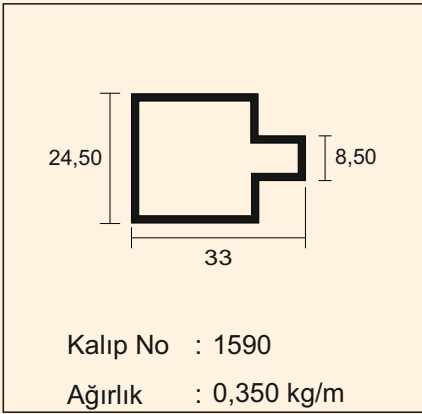
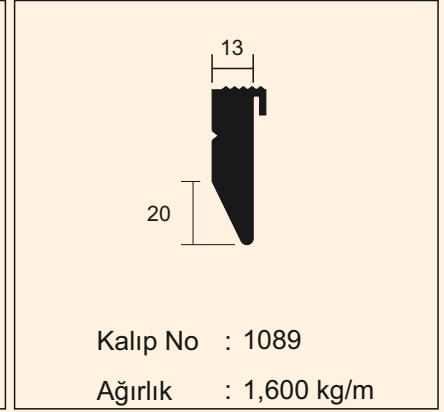
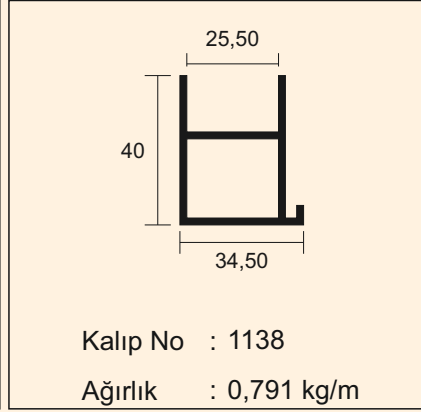
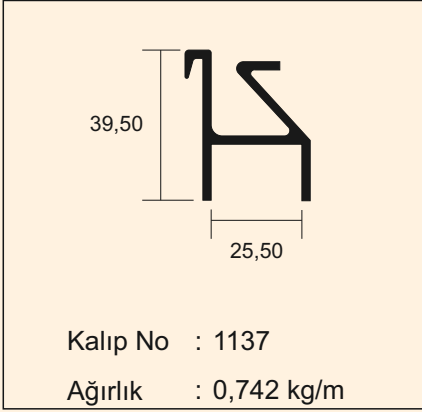

Katalogumuzda bulunan profil çizimleri örnek olarak konulmuştur. Müşterilerimize ait olan çizimlerin profilleri satılamaz. Çizimler üzerinden ölçü almayınız. Resimlerin altında yer alan profil ağırlığı bilgi amaçlı olup, ürünlerin teslim anındaki tartımız ağırlığı geçerlidir.

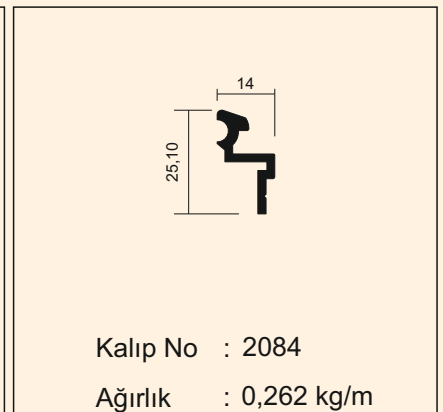
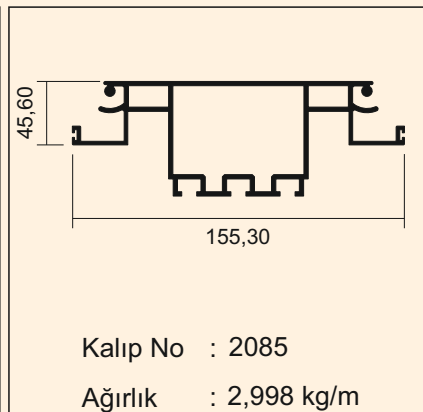
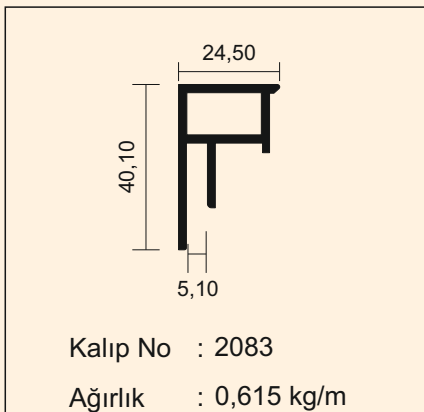
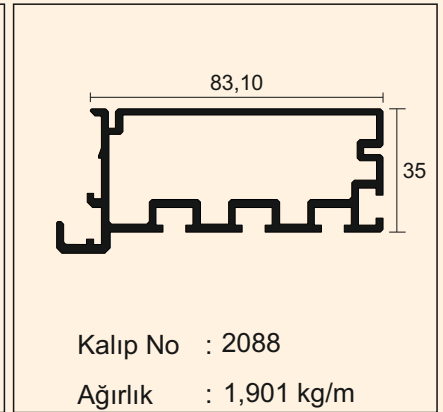
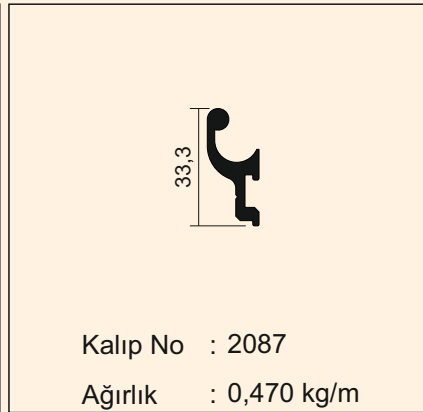
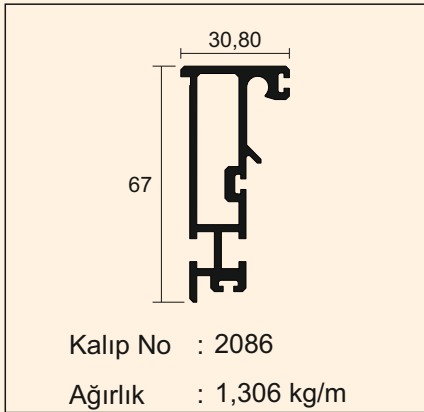
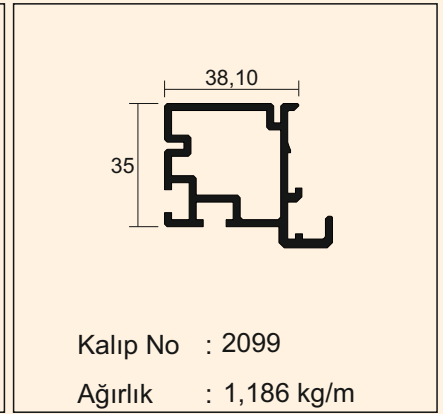
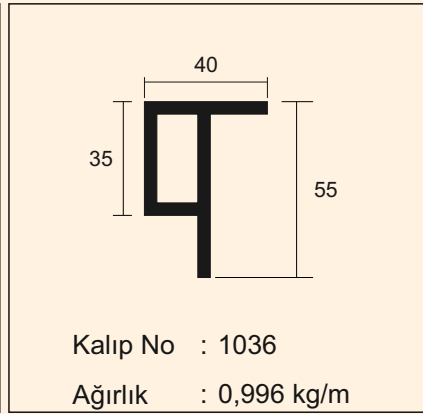
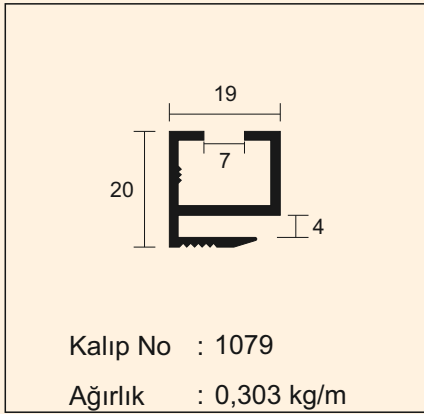
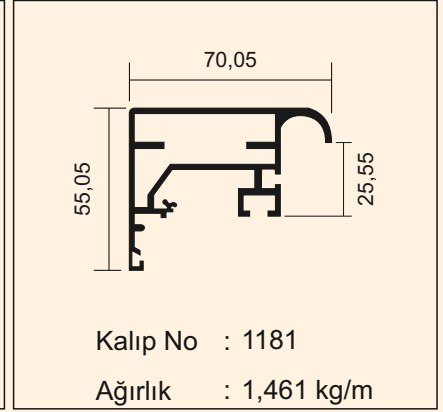
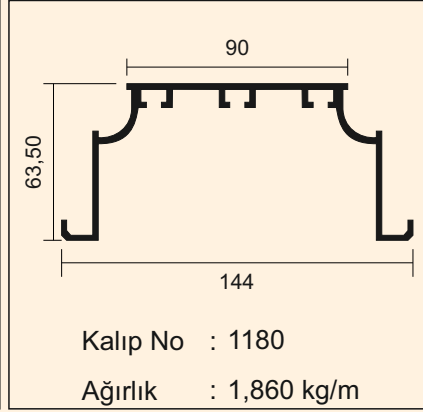
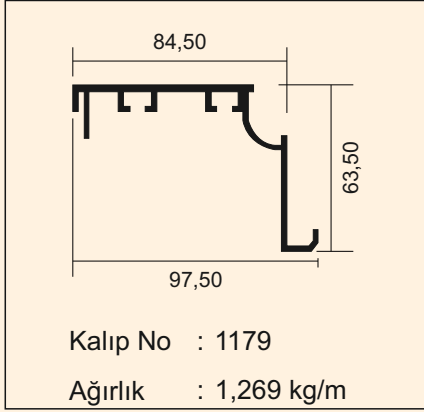

Kataloğumuzda bulunan profil çizimleri örnek olarak konulmuştur. Müşterilerimize ait olan çizimlerin profilleri satılamaz. Çizimler üzerinden ölçü almayınız. Resimlerin altında yer alan profil ağırlığı bilgi amaçlı olup, ürünlerin teslim anındaki tartımız ağırlığı geçerlidir.

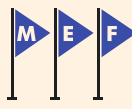

çözümün bir parçasıyız

MEF METAL

to be a part of solution

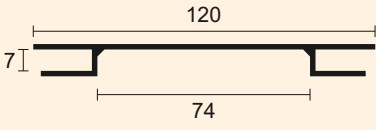

Kalıp No : 1145

Ağırlık : 1,000 kg/m

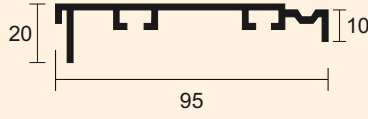

Kalıp No : 1187

Ağırlık : 0,933 kg/m

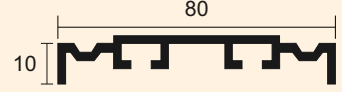

Kalıp No : 1188

Ağırlık : 0,786 kg/m

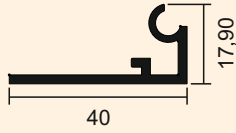

Kalıp No : 1695

Ağırlık : 0,378 kg/m

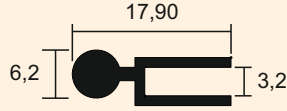

Kalıp No : 1694

Ağırlık : 0,150 kg/m

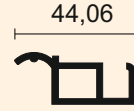

Kalıp No : 1243

Ağırlık : 0,581 kg/m

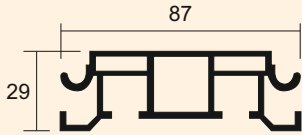

Kalıp No : 1240

Ağırlık : 1,609 kg/m

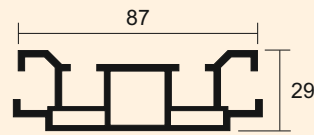

Kalıp No : 1242

Ağırlık : 1,593 kg/m

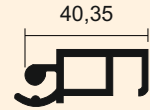

Kalıp No : 1241

Ağırlık : 0,707 kg/m

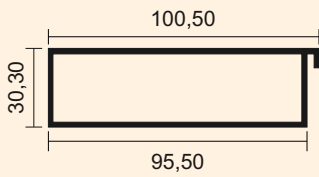

Kalıp No : 1300

Ağırlık : 1,161 kg/m

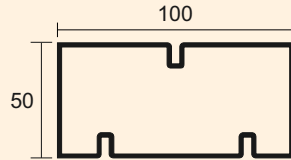

Kalıp No : 1221

Ağırlık : 1,747 kg/m

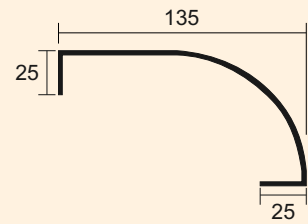

Kalıp No : 1297

Ağırlık : 1,258 kg/m

Katalogumuzda bulunan profil çizimleri örnek olarak konulmuştur. Müşterilerimize ait olan çizimlerin profilleri satılamaz. Çizimler üzerinden ölçü almayınız. Resimlerin altında yer alan profil ağırlığı bilgi amaçlı olup, ürünlerin teslim anındaki tartımız ağırlığı geçerlidir.

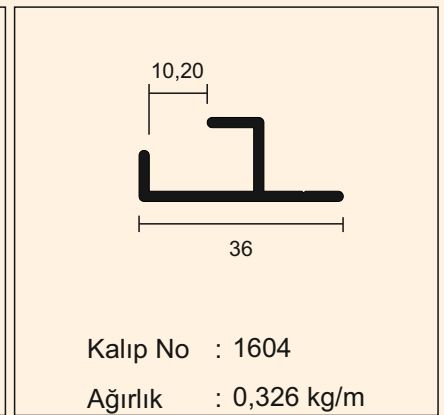
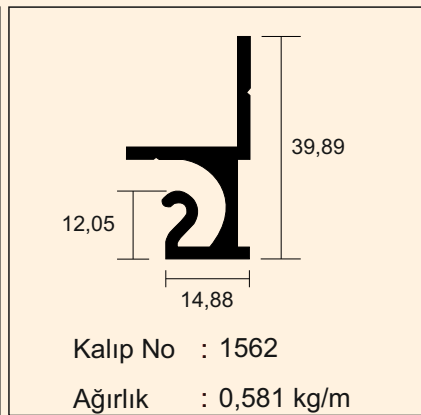
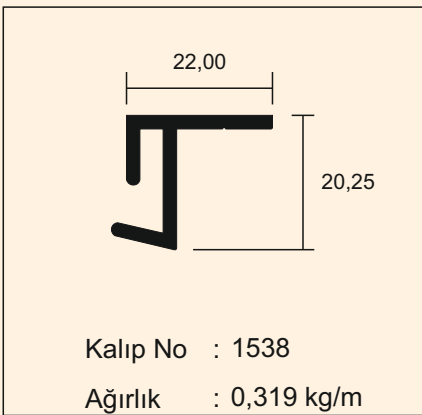
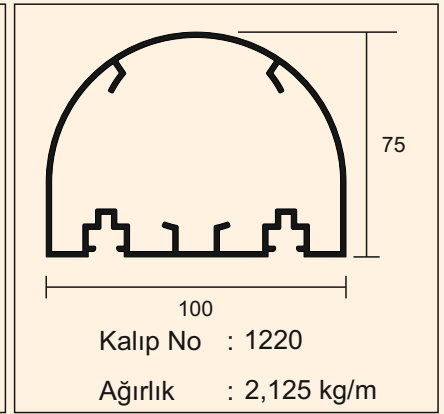
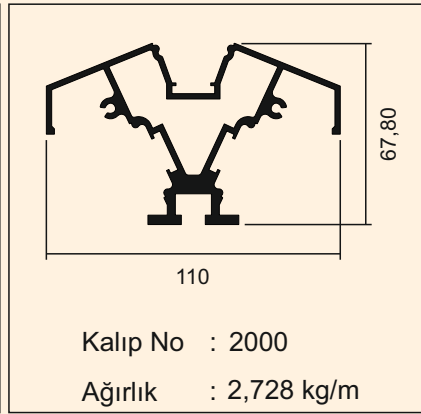
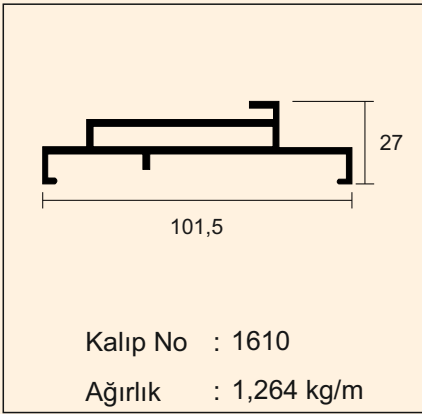
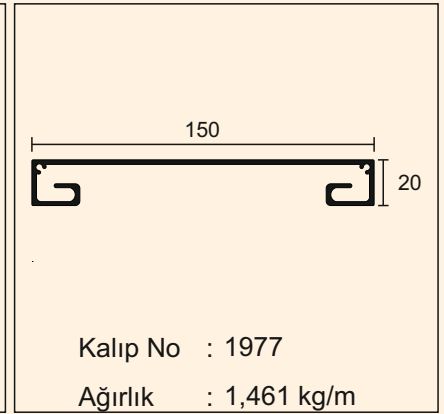
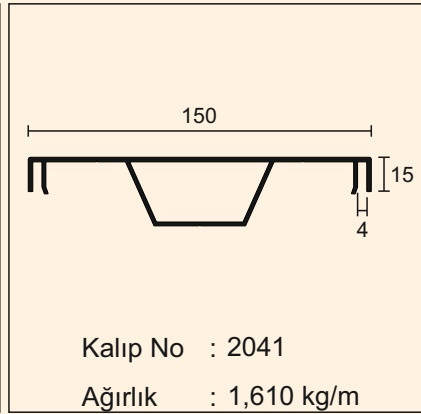
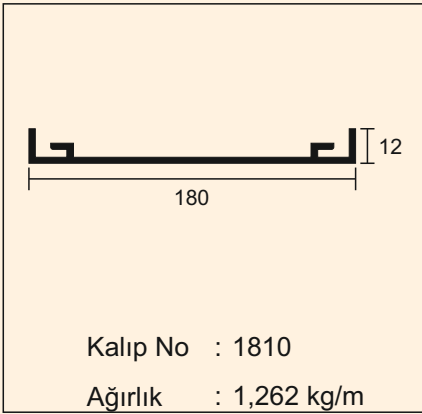
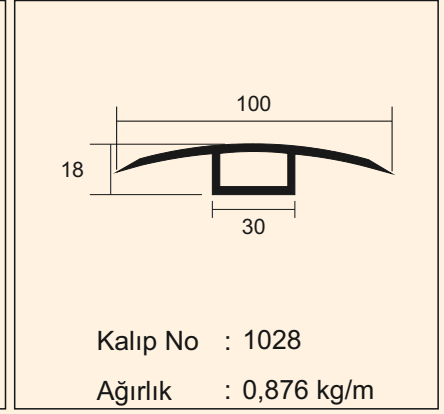
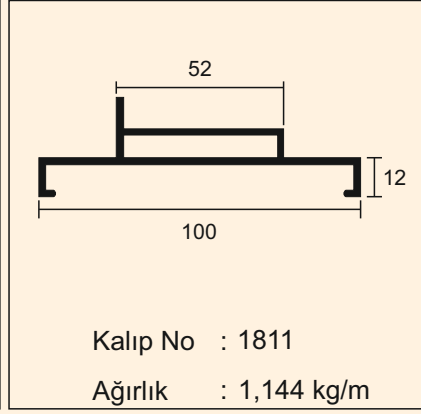
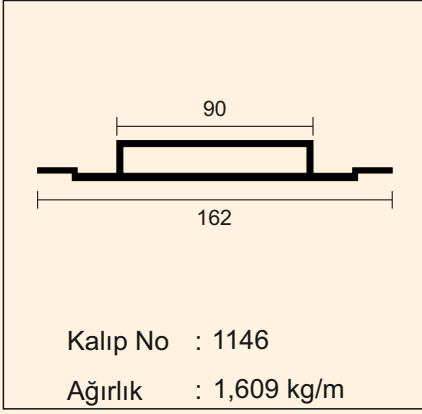

Katalogumuzda bulunan profil çizimleri örnek olarak konulmuştur. Müşterilerimize ait olan çizimlerin profilleri satılamaz. Çizimler üzerinden ölçü almayınız. Resimlerin altında yer alan profil ağırlığı bilgi amaçlı olup, ürünlerin teslim anındaki tartımız ağırlığı geçerlidir.

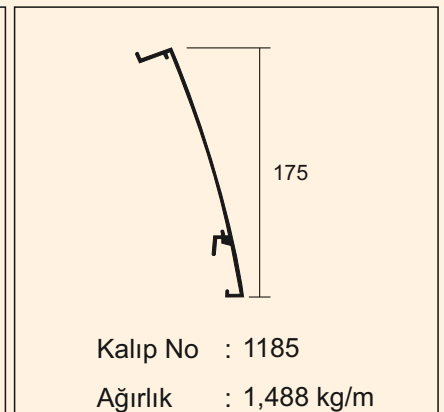
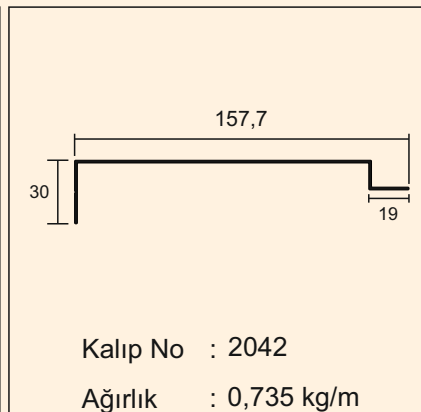
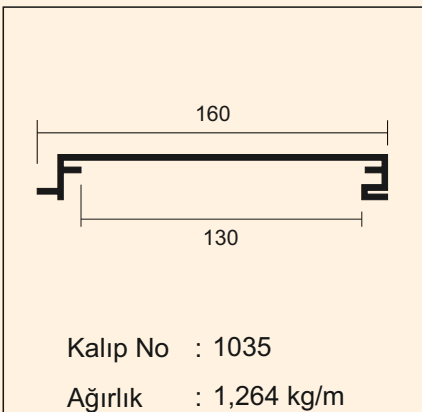
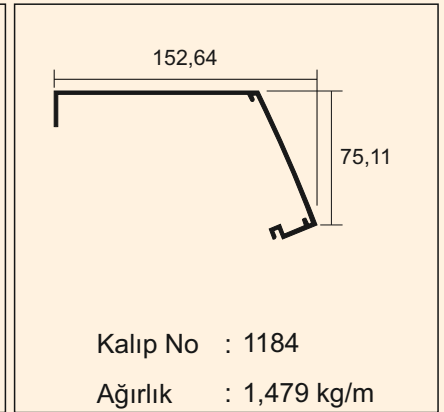
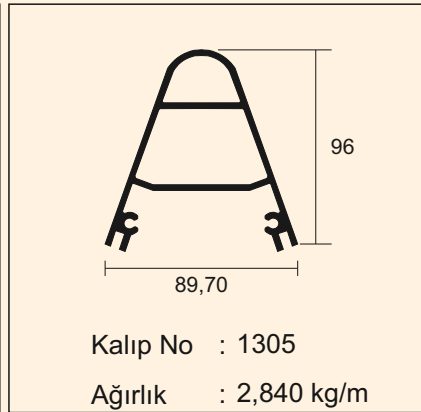
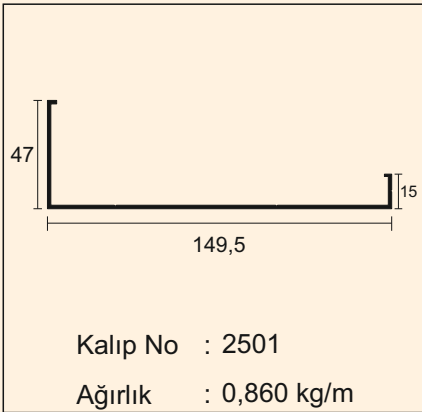
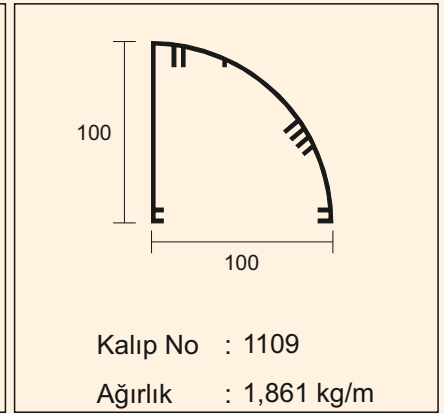
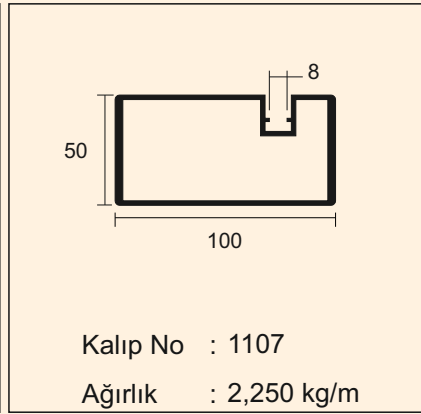
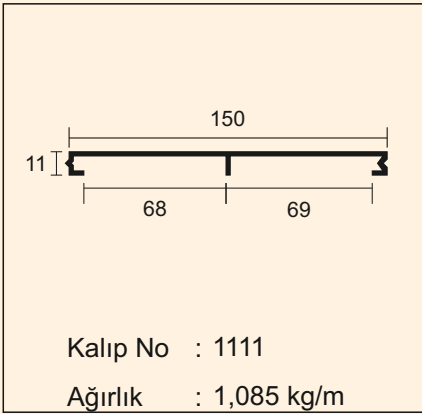
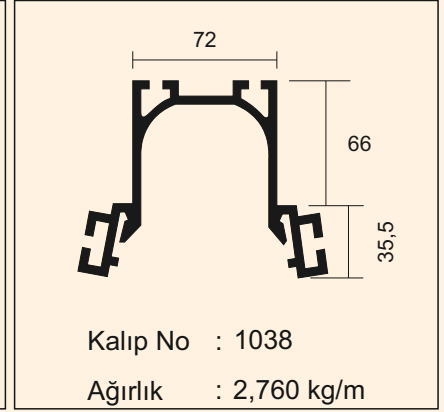
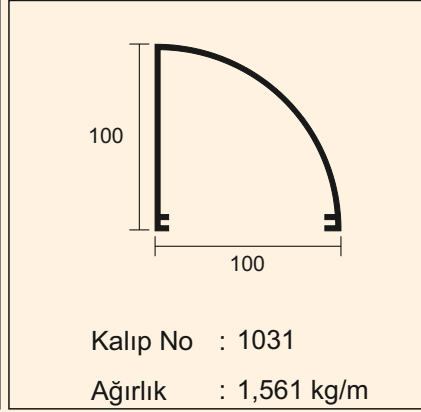
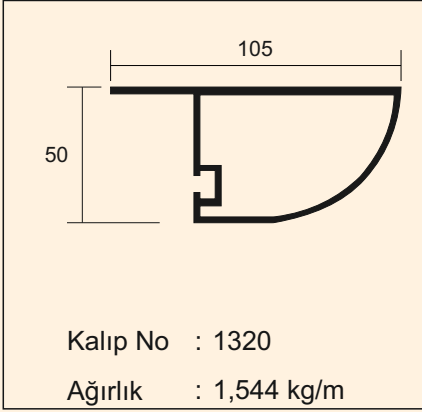

Kataloğumuzda bulunan profil çizimleri örnek olarak konulmuştur. Müşterilerimize ait olan çizimlerin profilleri satılamaz. Çizimler üzerinden ölçü almayınız. Resimlerin altında yer alan profil ağırlığı bilgi amaçlı olup, ürünlerin teslim anındaki tartımız ağırlığı geçerlidir.

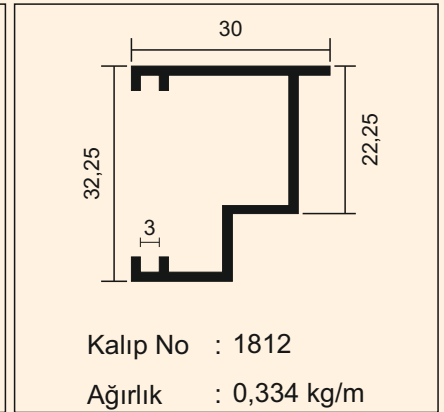
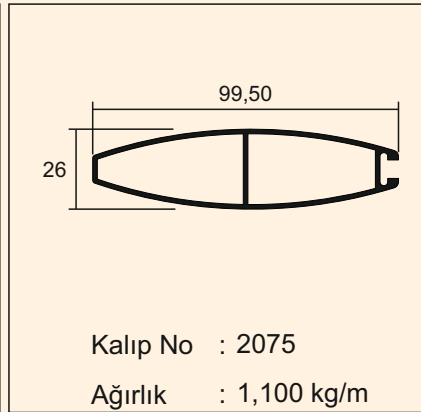
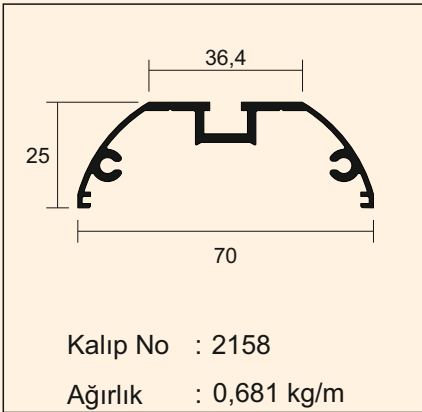
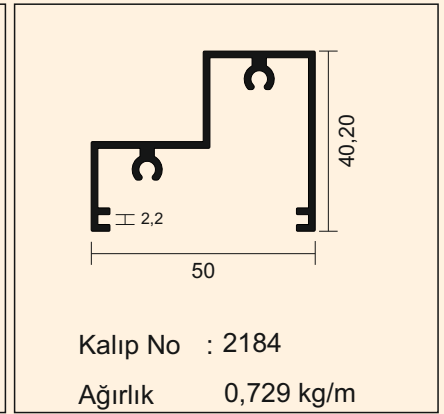
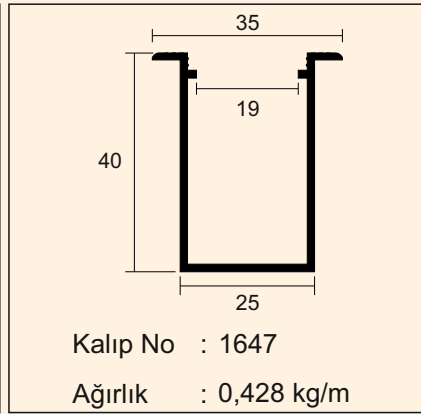
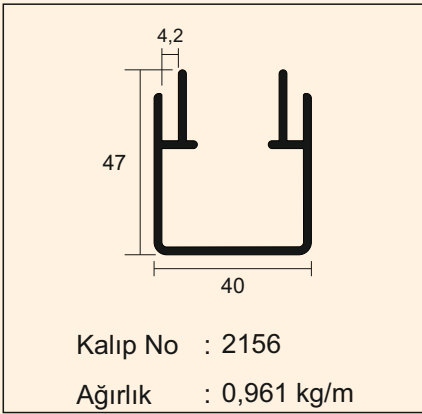
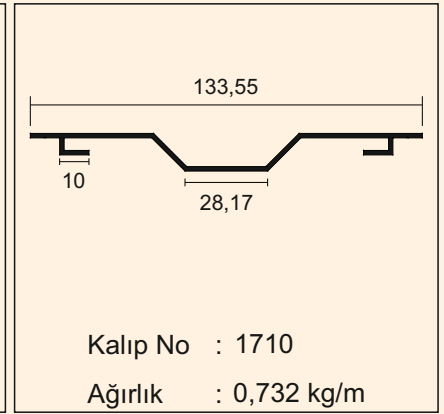
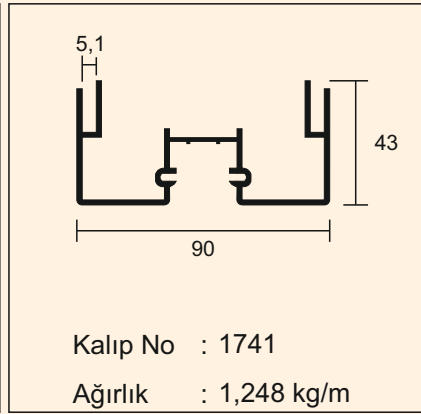
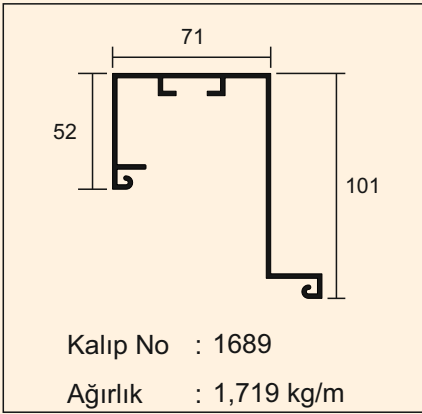
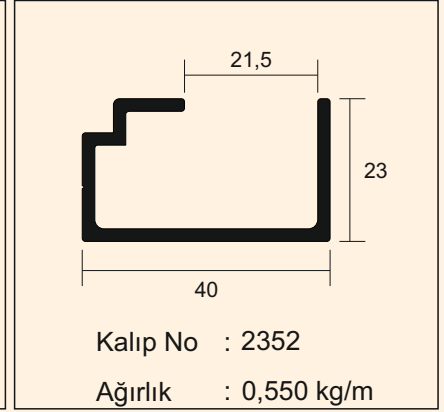
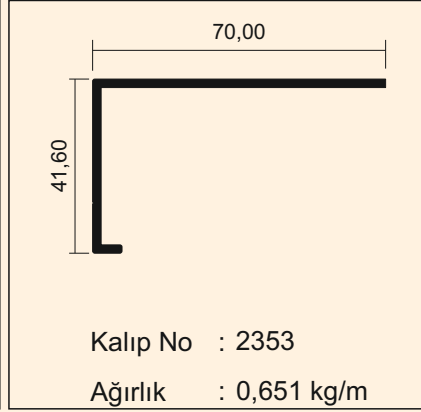
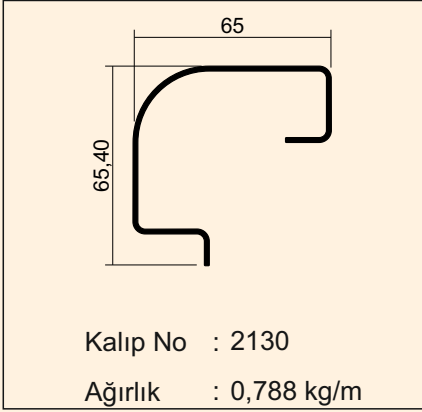

Katalogumuzda bulunan profil çizimleri örnek olarak konulmuştur. Müşterilerimize ait olan çizimlerin profilleri satılamaz. Çizimler üzerinden ölçü almayınız. Resimlerin altında yer alan profil ağırlığı bilgi amaçlı olup, ürünlerin teslim anındaki tartımız ağırlığı geçerlidir.

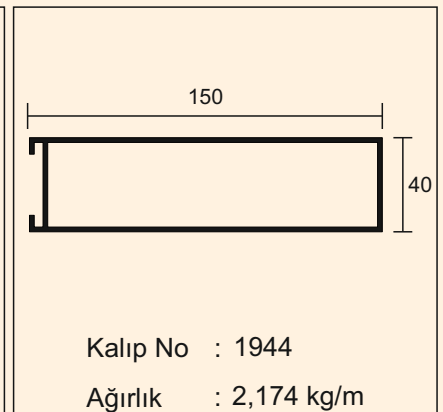
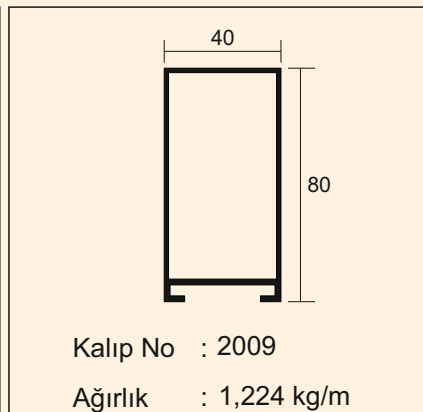
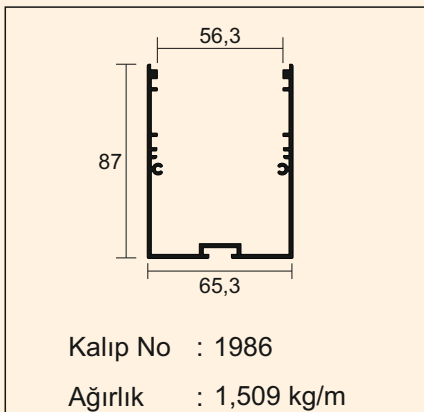
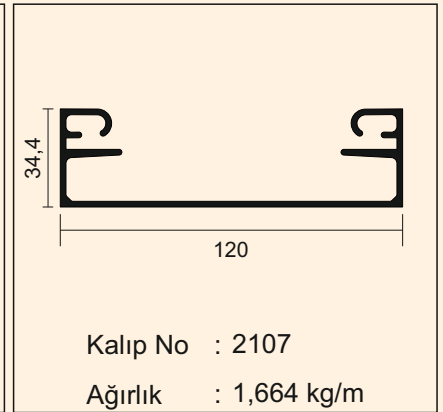
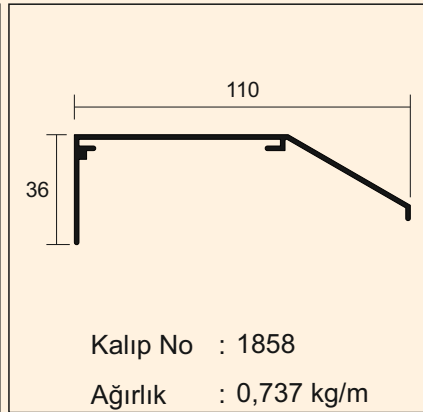
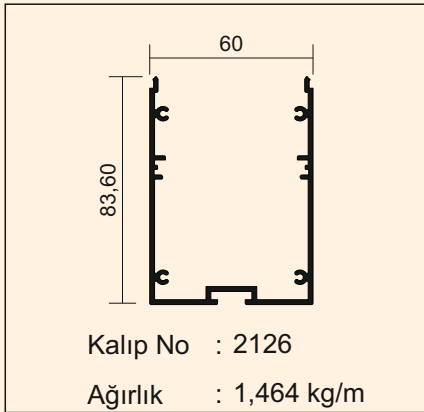
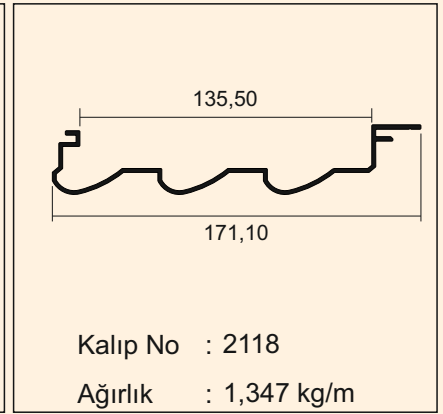
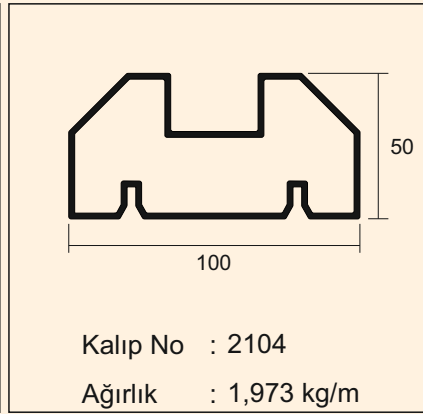
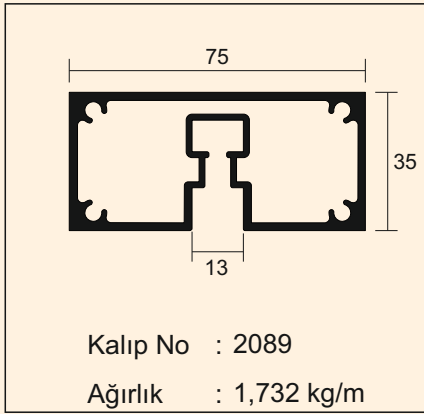
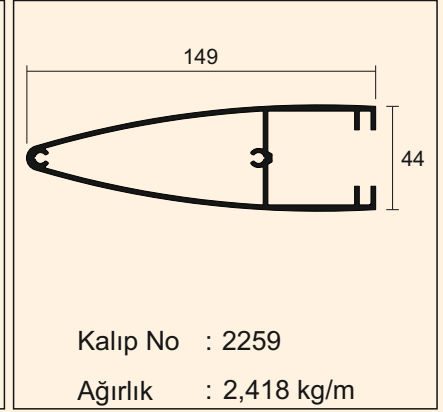
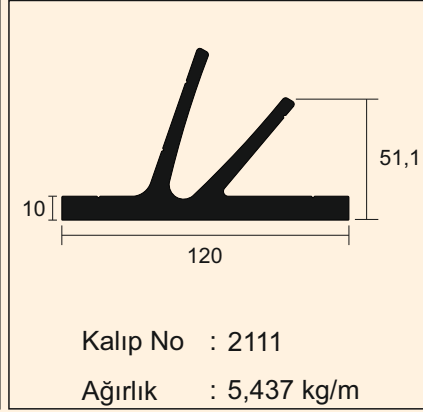
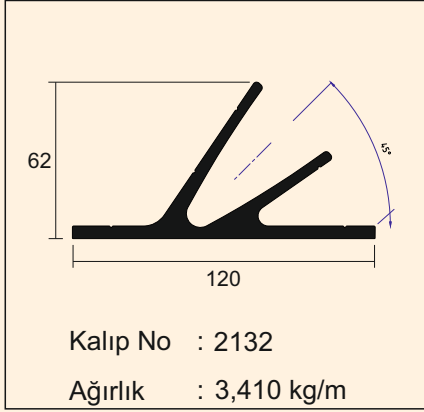

Kataloğumuzda bulunan profil çizimleri örnek olarak konulmuştur. Müşterilerimize ait olan çizimlerin profilleri satılamaz. Çizimler üzerinden ölçü almayınız. Resimlerin altında yer alan profil ağırlığı bilgi amaçlı olup, ürünlerin teslim anındaki tartımız ağırlığı geçerlidir.

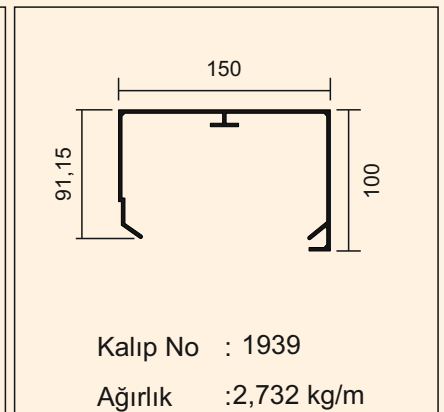
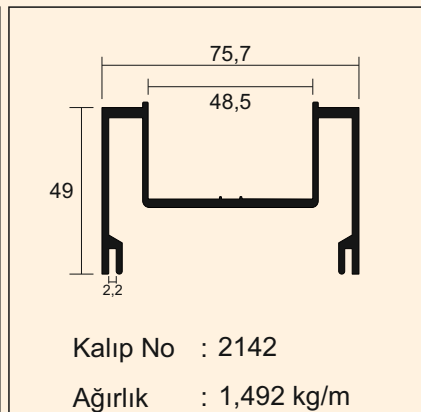
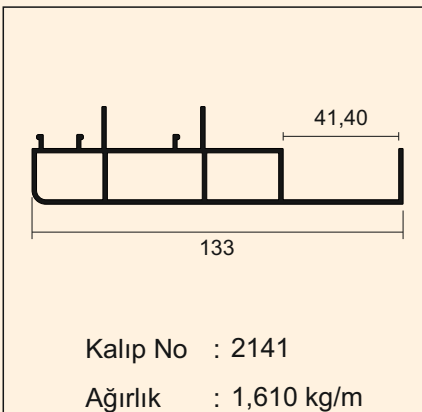
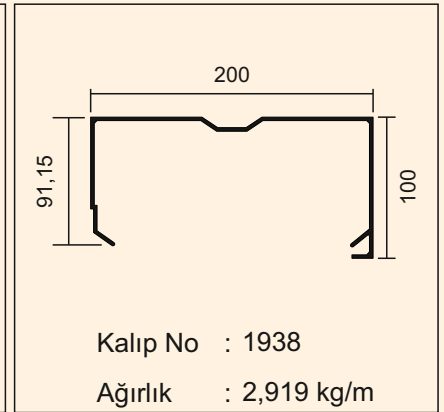
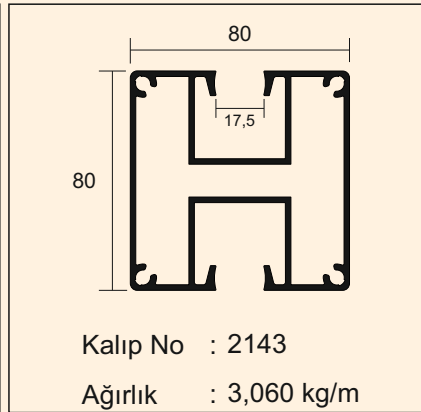
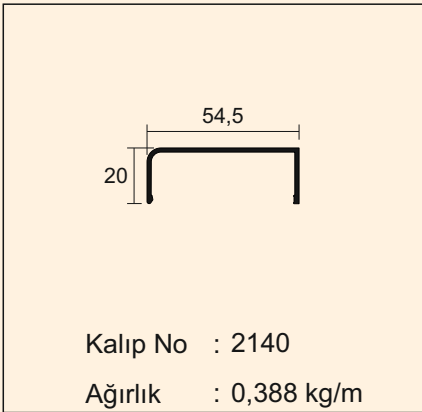
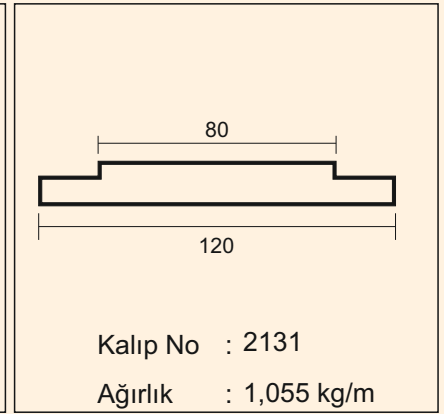
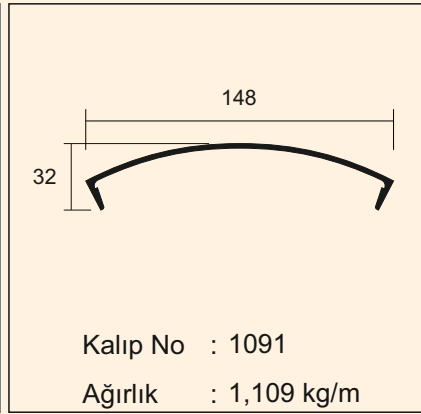
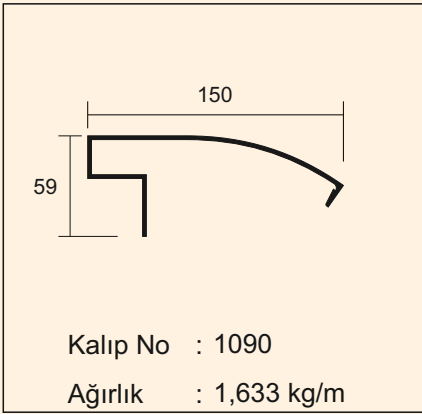
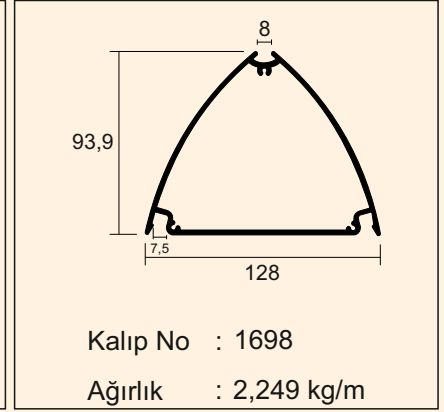
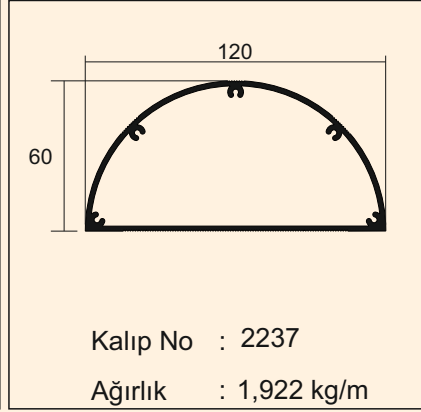
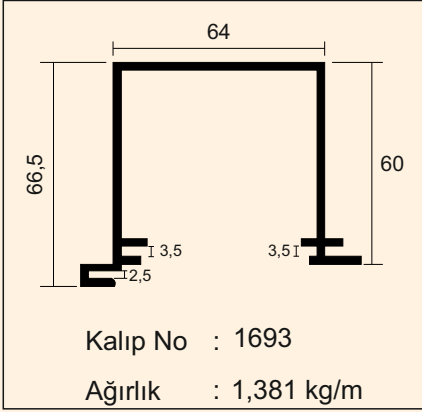

Kataloğumuzda bulunan profil çizimleri örnek olarak konulmuştur. Müşterilerimize ait olan çizimlerin profilleri satılamaz. Çizimler üzerinden ölçü almayınız. Resimlerin altında yer alan profil ağırlığı bilgi amaçlı olup, ürünlerin teslim anındaki tartımız ağırlığı geçerlidir.

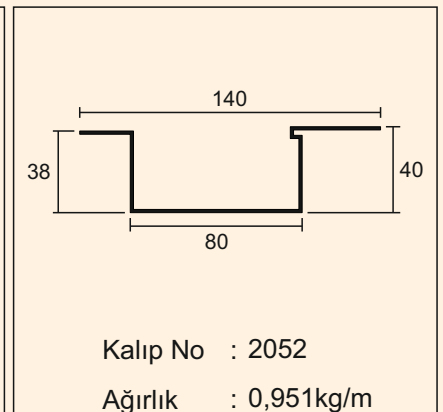
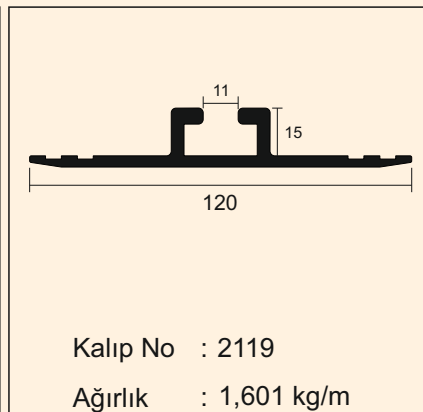
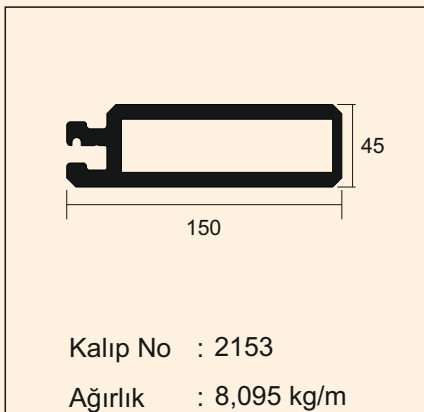
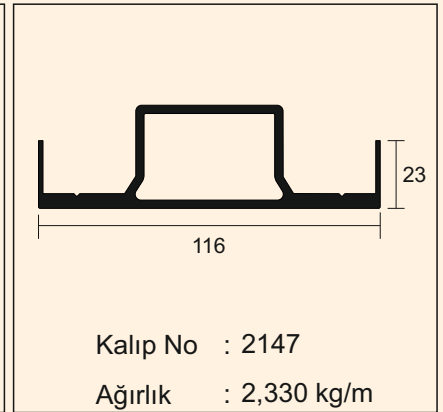
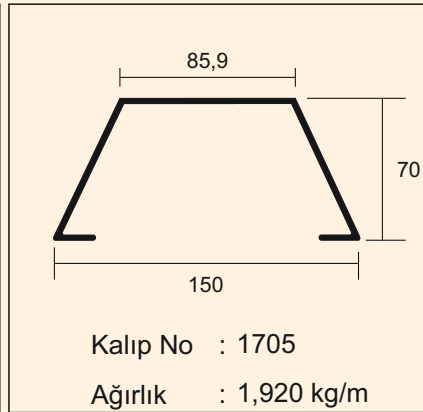
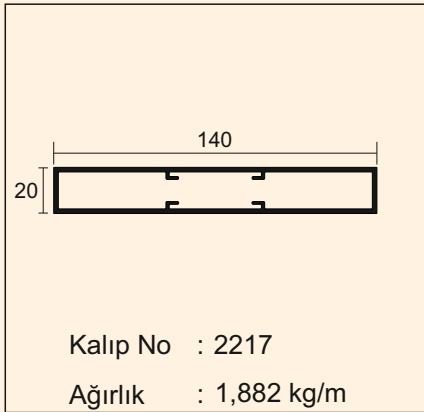
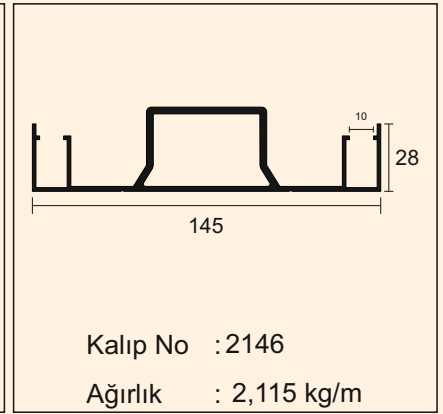
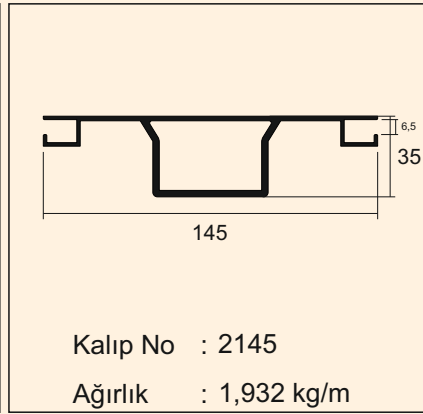
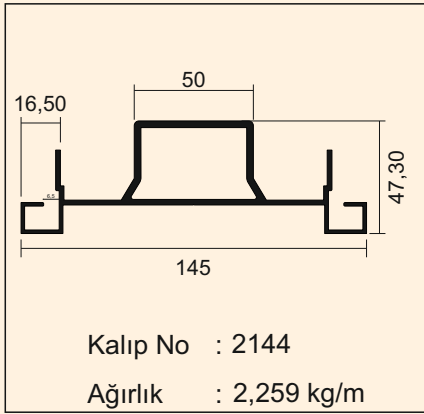
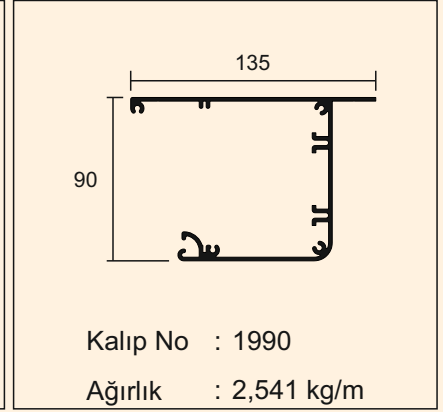
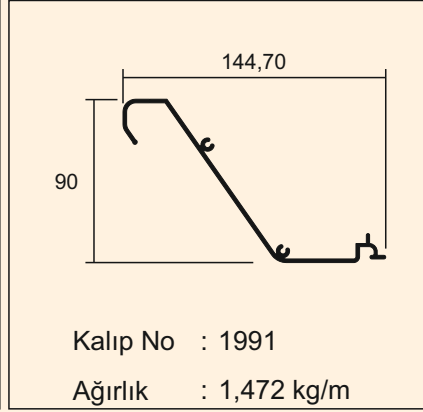
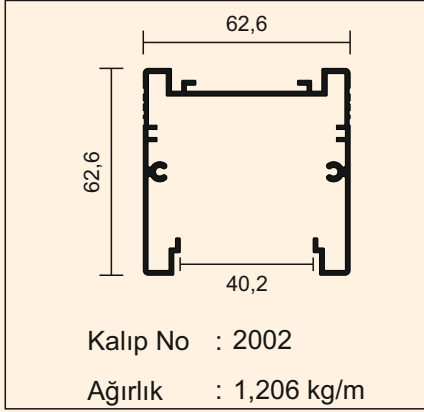

Kataloğumuzda bulunan profil çizimleri örnek olarak konulmuştur. Müşterilerimize ait olan çizimlerin profilleri satılamaz. Çizimler üzerinden ölçü almayınız. Resimlerin altında yer alan profil ağırlığı bilgi amaçlı olup, ürünlerin teslim anındaki tartımız ağırlığı geçerlidir.

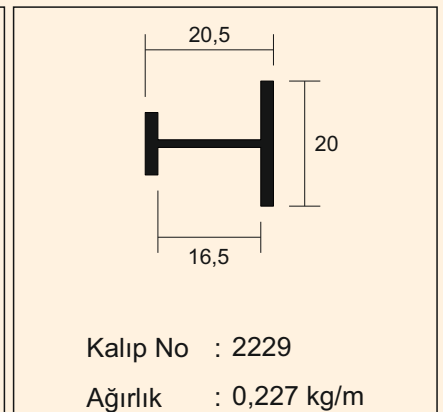
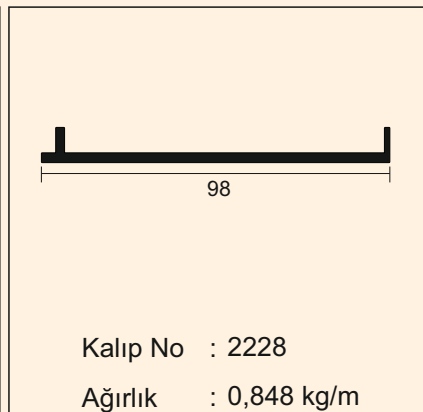
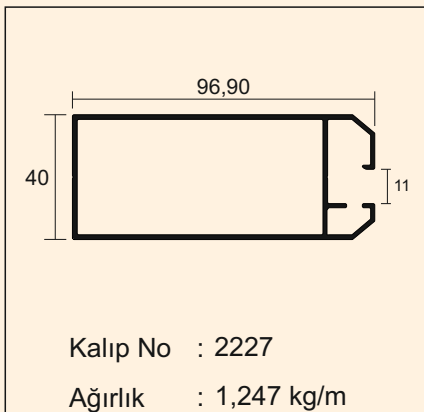
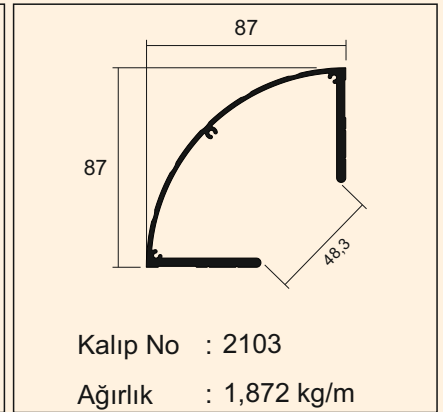
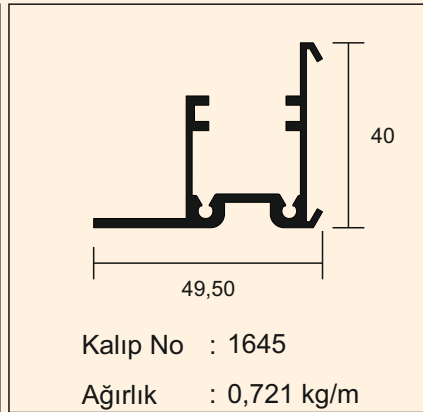
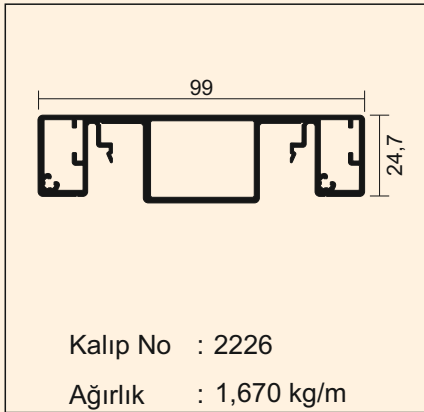
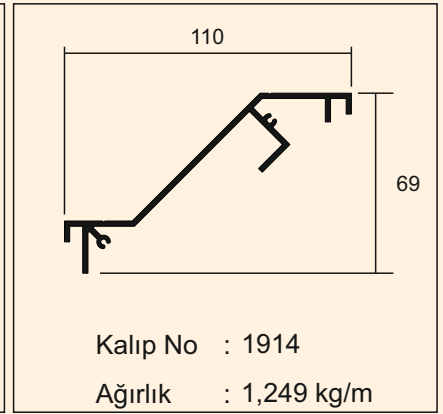
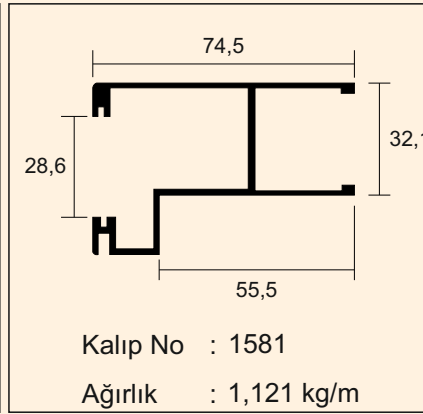
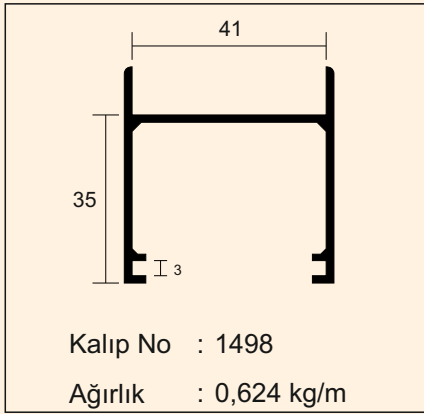
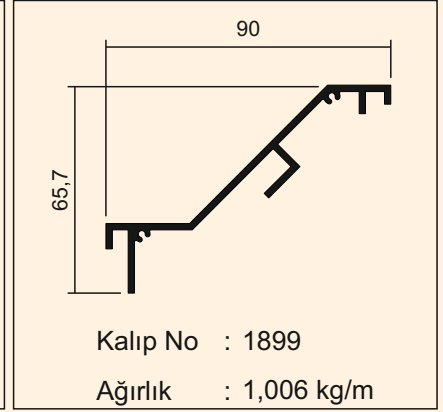
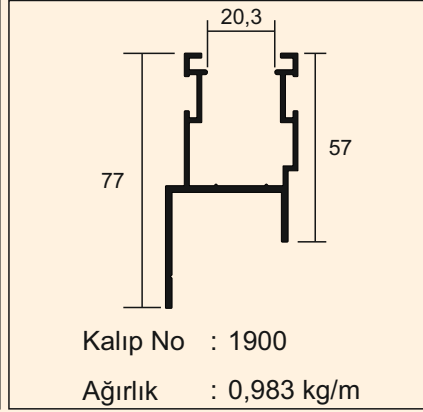
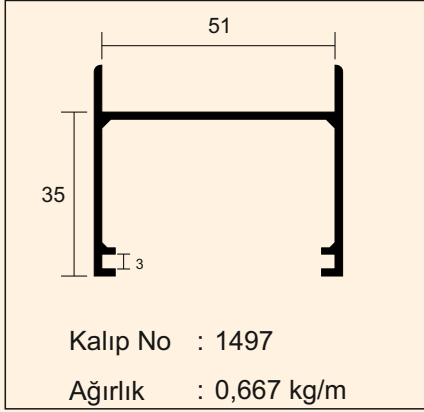

Katalogumuzda bulunan profil çizimleri örnek olarak konulmuştur. Müşterilerimize ait olan çizimlerin profilleri satılamaz. Çizimler üzerinden ölçü almayınız. Resimlerin altında yer alan profil ağırlığı bilgi amaçlı olup, ürünlerin teslim anındaki tartımız ağırlığı geçerlidir.

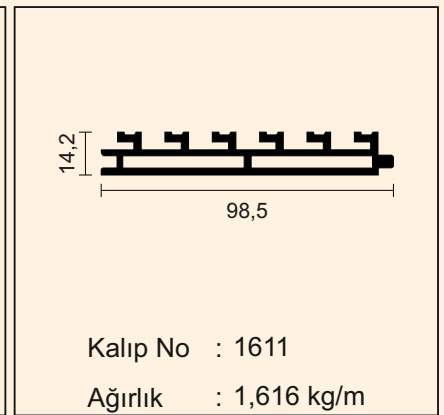
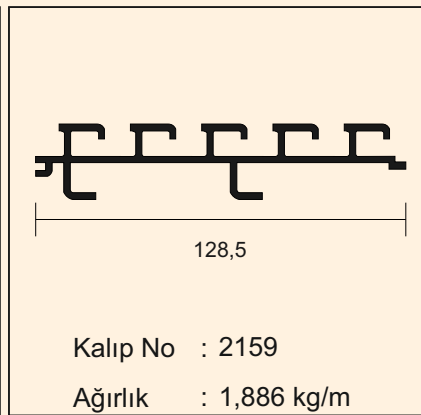
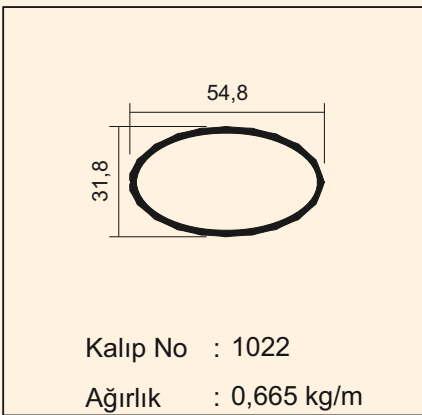
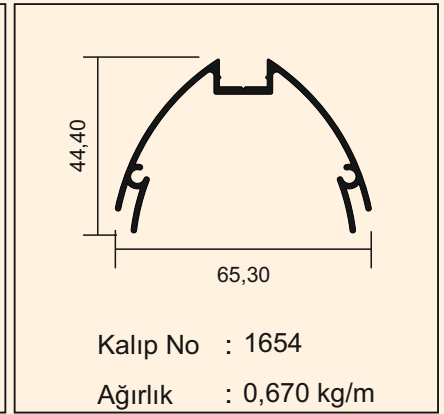
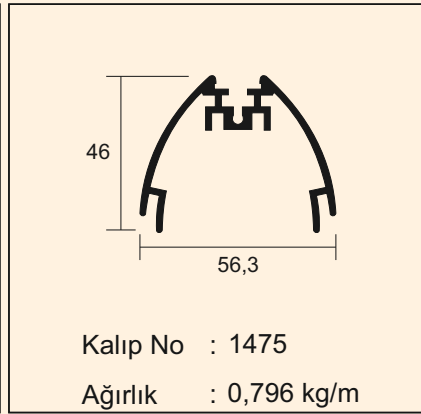
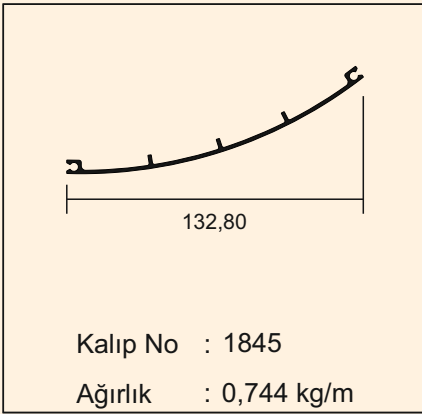
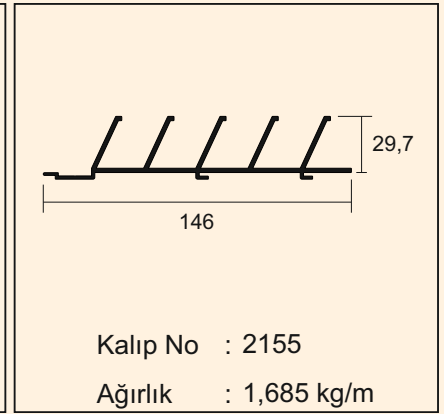
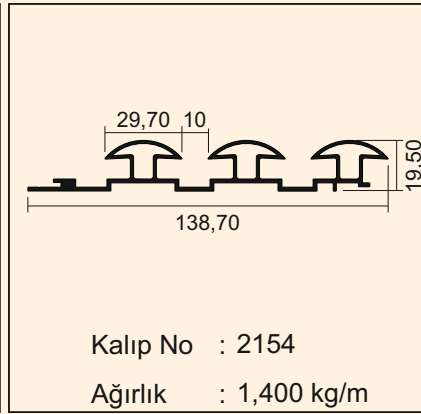
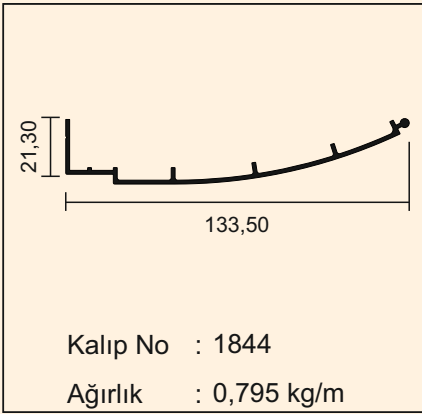
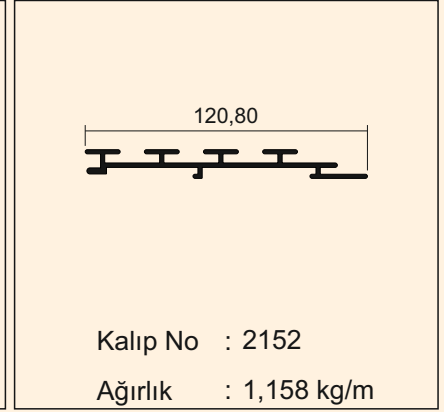
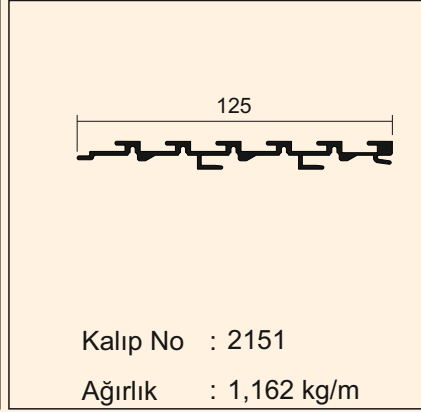
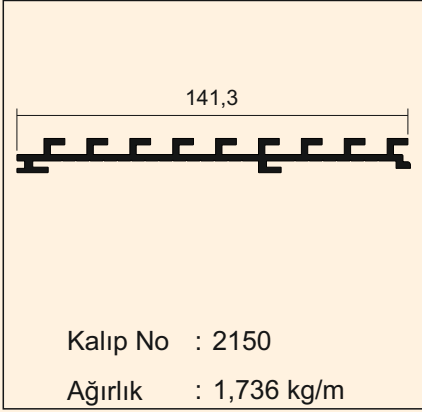

Katalogumuzda bulunan profil çizimleri örnek olarak konulmuştur. Müşterilerimize ait olan çizimlerin profilleri satılamaz. Çizimler üzerinden ölçü almayınız. Resimlerin altında yer alan profil ağırlığı bilgi amaçlı olup, ürünlerin teslim anındaki tartımız ağırlığı geçerlidir.

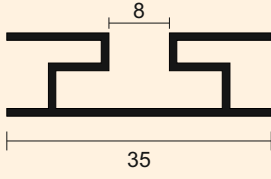

Kalıp No : 2329

Ağırlık : 0,267 kg/m

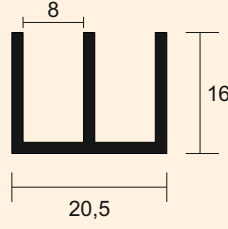

Kalıp No : 2327

Ağırlık : 0,273 kg/m

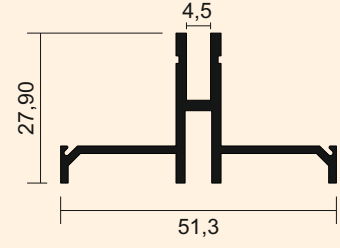

Kalıp No : 2311

Ağırlık : 0,529 kg/m

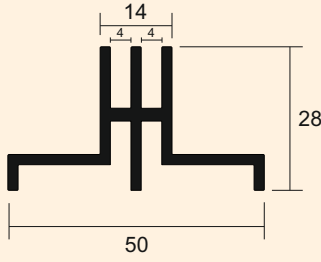

Kalıp No : 2160

Ağırlık : 0,739 kg/m

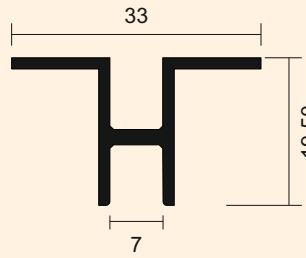

Kalıp No : 2161

Ağırlık : 0,305 kg/m

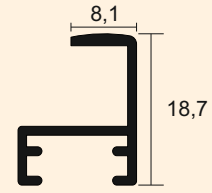

Kalıp No : 2162

Ağırlık : 0,167 kg/m



Kalıp No : 2163

Ağırlık : 1,682 kg/m

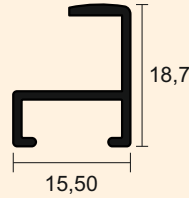

Kalıp No : 2164

Ağırlık : 0,159 kg/m

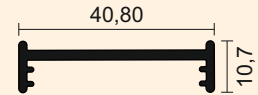

Kalıp No : 2165

Ağırlık : 0,328 kg/m

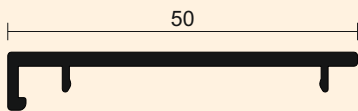

Kalıp No : 2166

Ağırlık : 0,337 kg/m

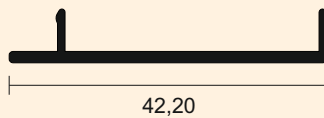

Kalıp No : 2167

Ağırlık : 0,211 kg/m

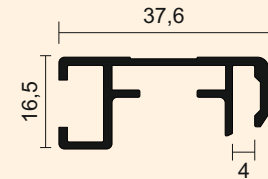

Kalıp No : 2310

Ağırlık : 0,401 kg/m

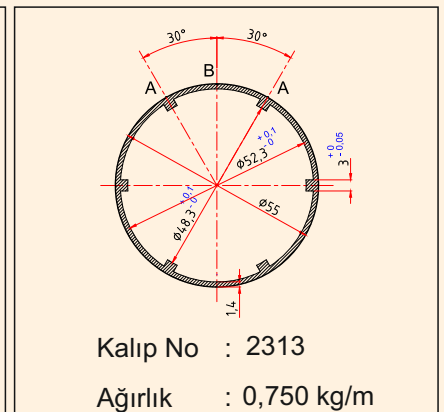
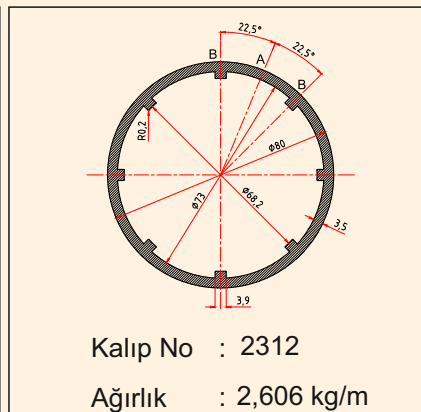
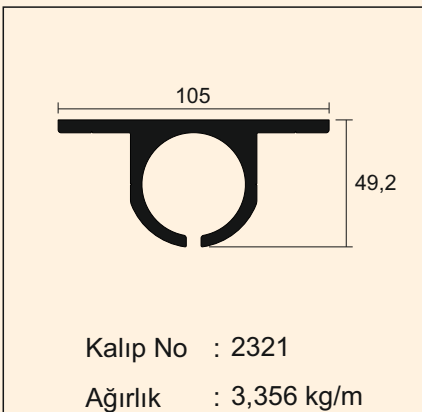
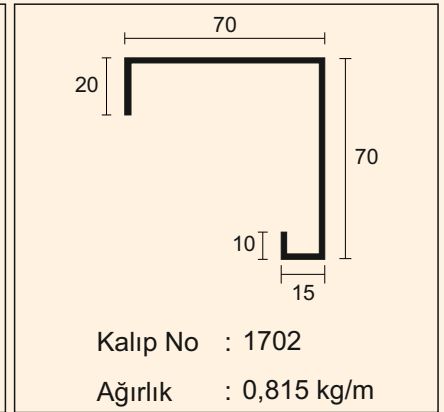
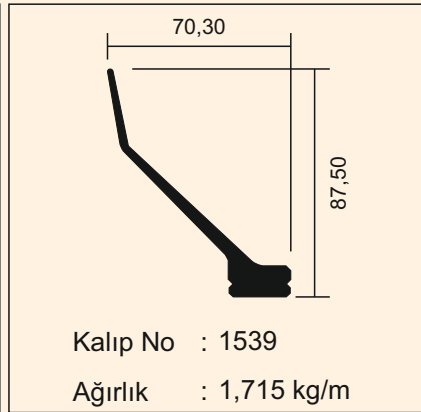
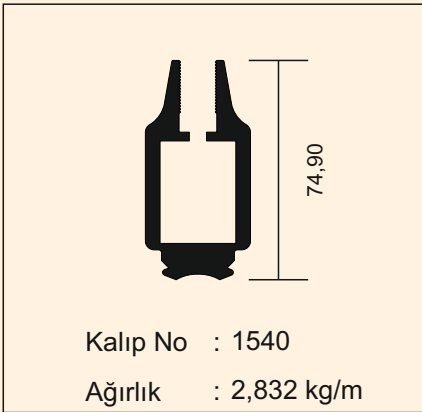
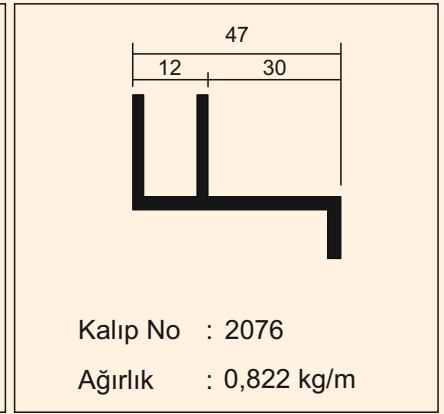
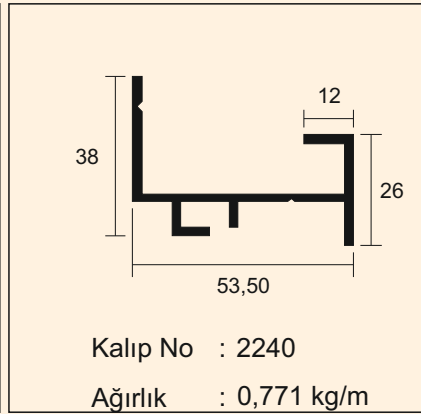
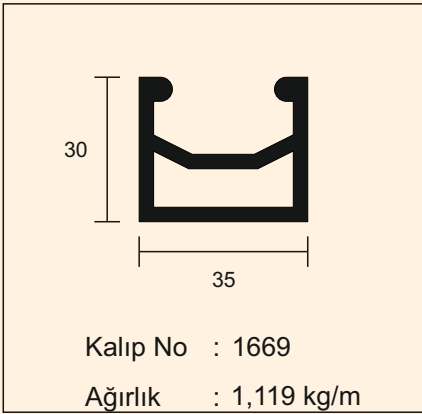
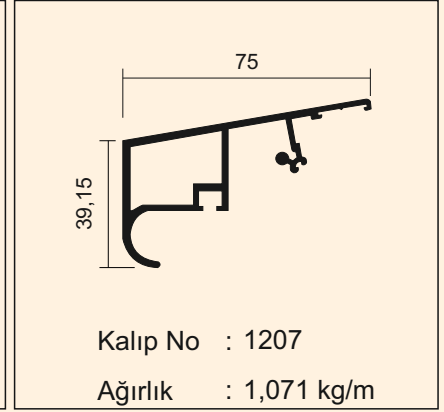
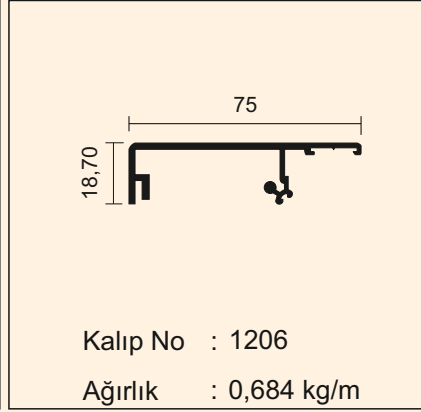
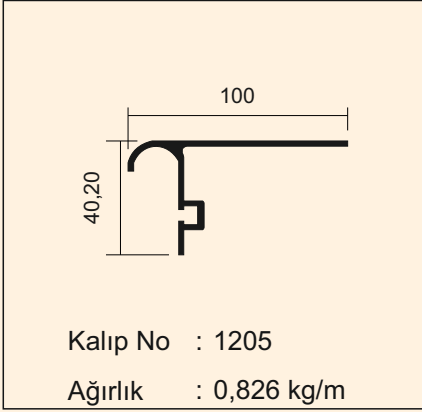

Katalogumuzda bulunan profil çizimleri örnek olarak konulmuştur. Müşterilerimize ait olan çizimlerin profilleri satılamaz. Çizimler üzerinden ölçü almayınız. Resimlerin altında yer alan profil ağırlığı bilgi amaçlı olup, ürünlerin teslim anındaki tartımız ağırlığı geçerlidir.

Kalıp No : 1948
Ağırlık : 0,186 kg/m

Kalıp No : 2046
Ağırlık : 0,623 kg/m

Kalıp No : 2048
Ağırlık : 0,265 kg/m

Kalıp No : 1947
Ağırlık : 0,612 kg/m

Kalıp No : 2047
Ağırlık : 0,651 kg/m

Kalıp No : 2049
Ağırlık : 0,457 kg/m

Kalıp No : 2169
Ağırlık : 0,234 kg/m

Kalıp No : 1867
Ağırlık : 0,672 kg/m

Kalıp No : 2553
Ağırlık : 0,476 kg/m

Kalıp No : 2170
Ağırlık : 0,298 kg/m

Kalıp No : 1868
Ağırlık : 0,788 kg/m

Kalıp No : 2552
Ağırlık : 0,243 kg/m

Kataloğumuzda bulunan profil çizimleri örnek olarak konulmuştur. Müşterilerimize ait olan çizimlerin profilleri satılamaz. Çizimler üzerinden ölçü almayınız. Resimlerin altında yer alan profil ağırlığı bilgi amaçlı olup, ürünlerin teslim anındaki tartımız ağırlığı geçerlidir.

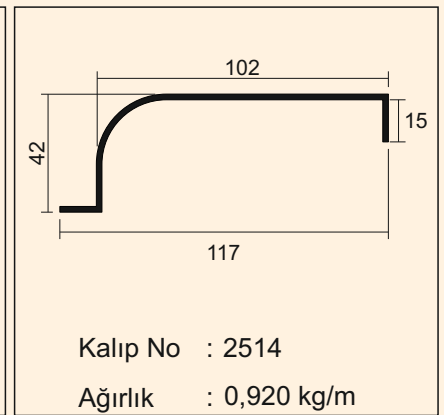
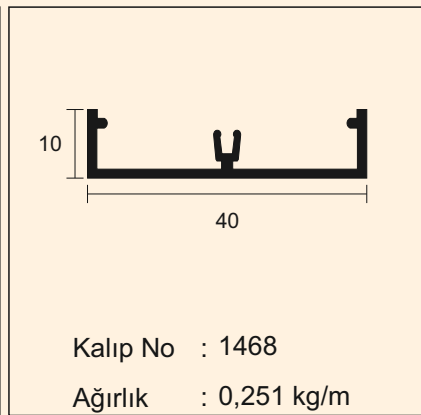
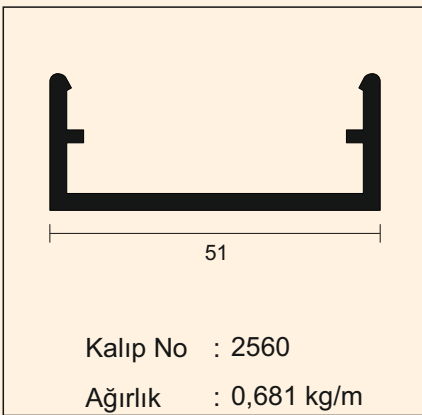
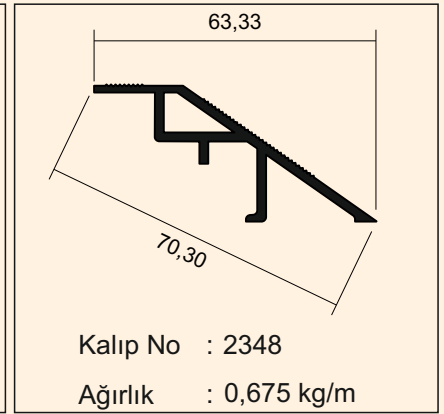
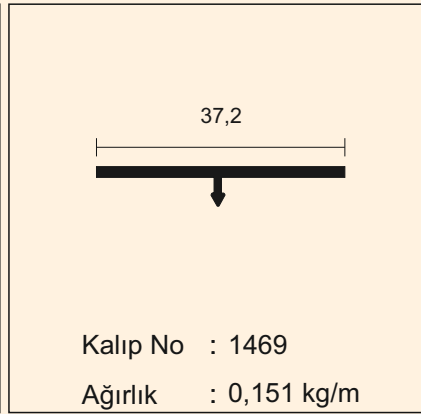
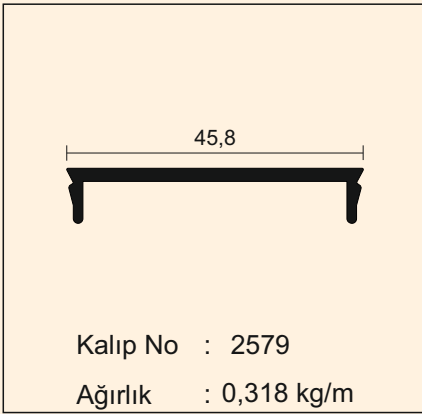
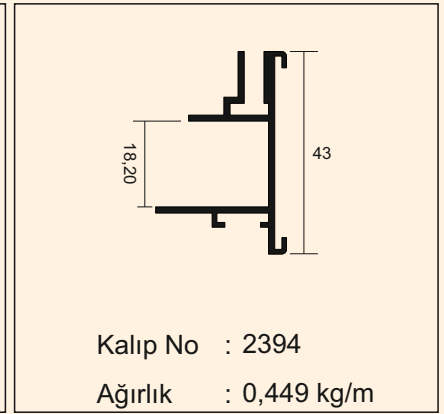
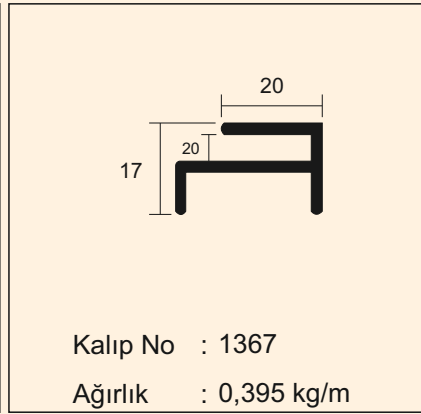
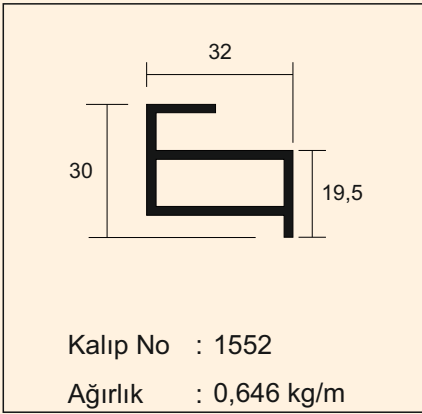
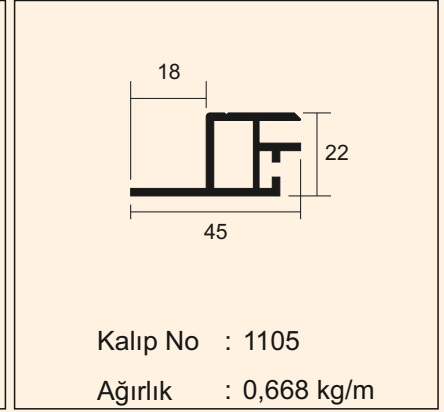
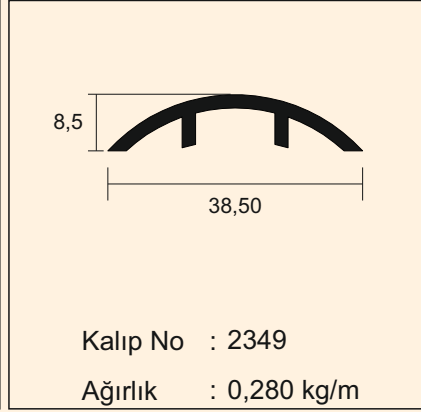
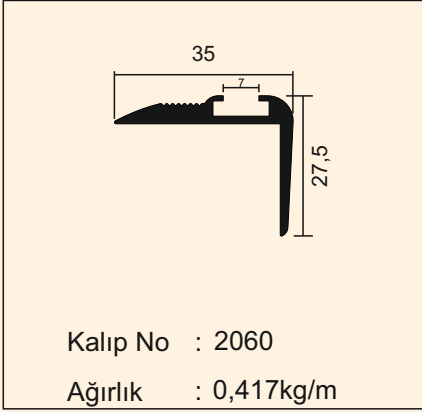

Katalogumuzda bulunan profil çizimleri örnek olarak konulmuştur. Müşterilerimize ait olan çizimlerin profilleri satılamaz. Çizimler üzerinden ölçü almayınız. Resimlerin altında yer alan profil ağırlığı bilgi amaçlı olup, ürünlerin teslim anındaki tartımız ağırlığı geçerlidir.

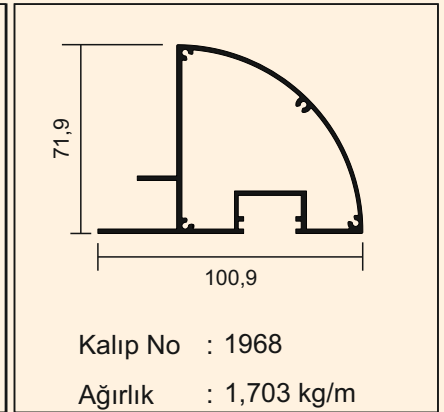
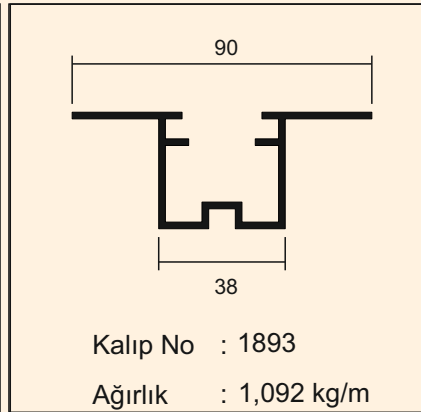
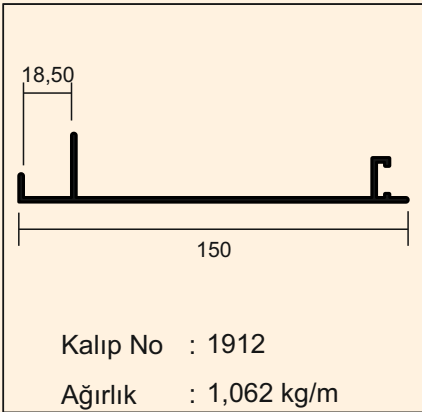
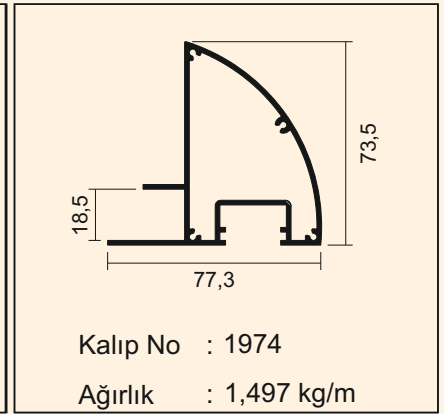
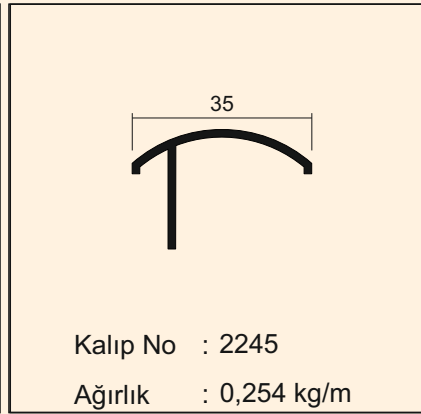
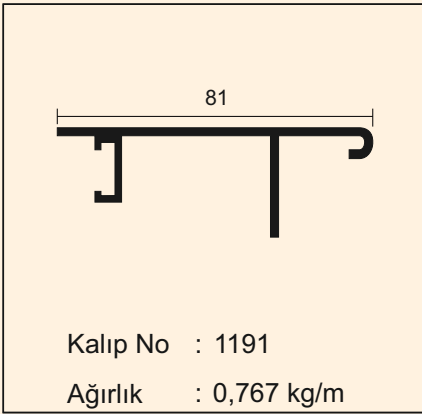
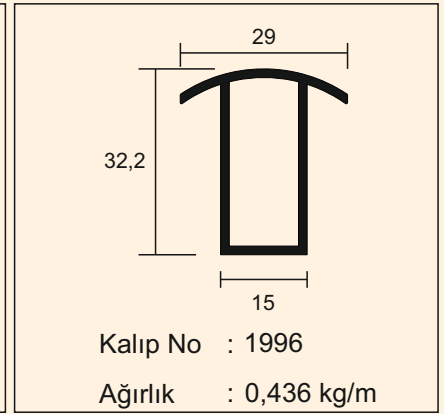
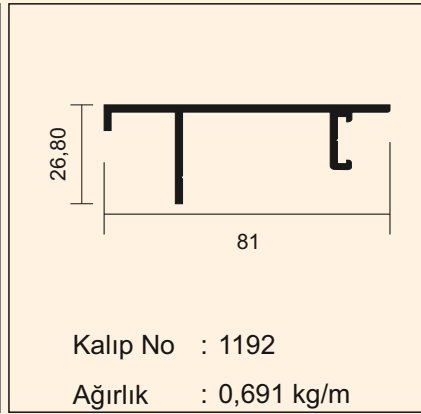
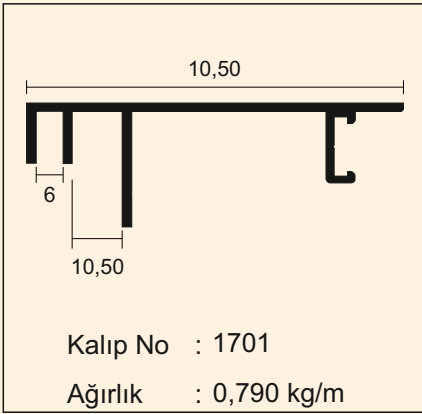
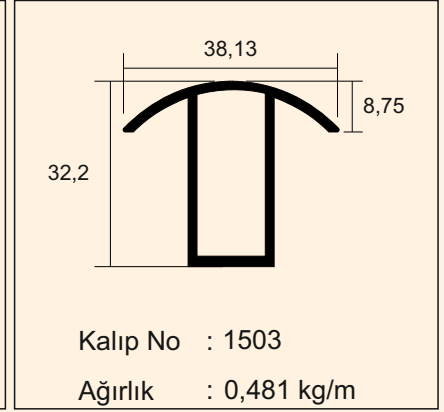
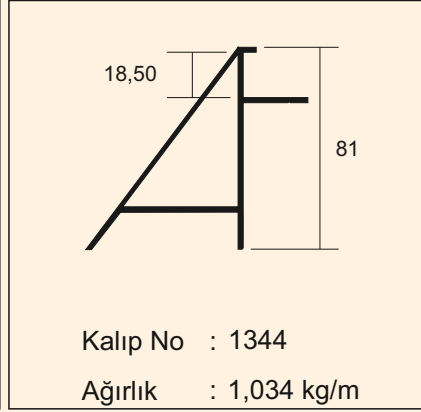
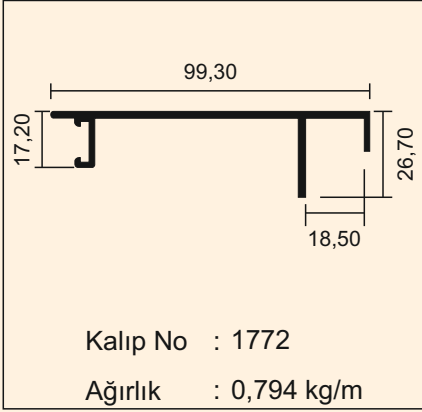

Kataloğumuzda bulunan profil çizimleri örnek olarak konulmuştur. Müşterilerimize ait olan çizimlerin profilleri satılamaz. Çizimler üzerinden ölçü almayınız. Resimlerin altında yer alan profil ağırlığı bilgi amaçlı olup, ürünlerin teslim anındaki tartımız ağırlığı geçerlidir.

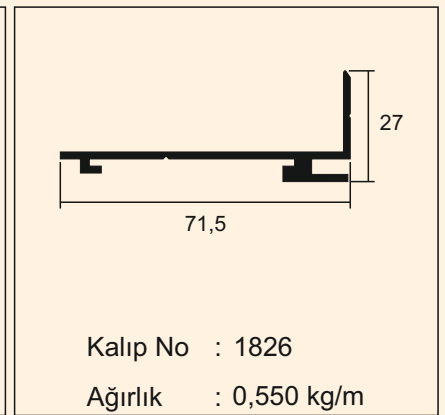
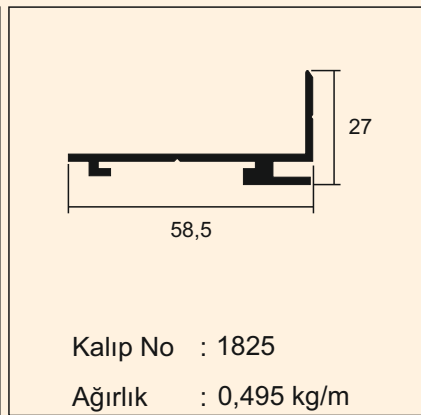
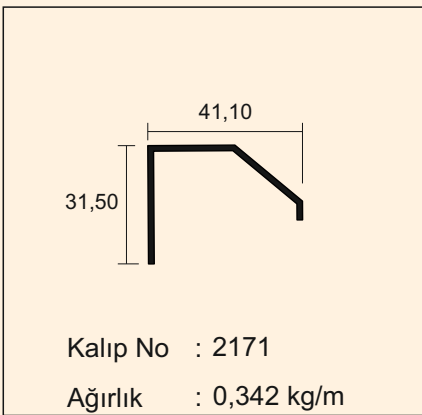
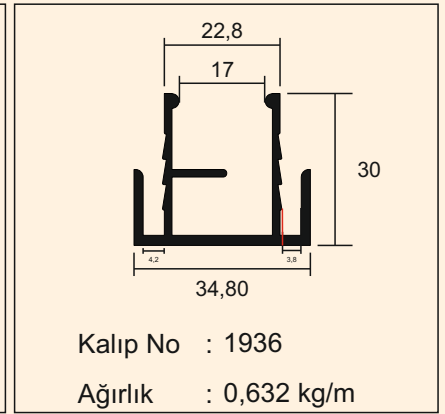
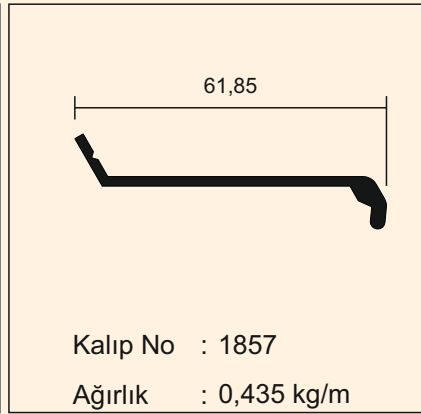
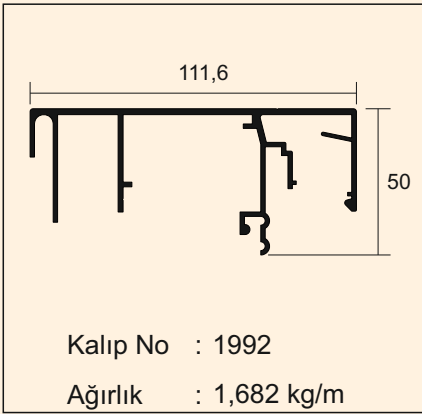
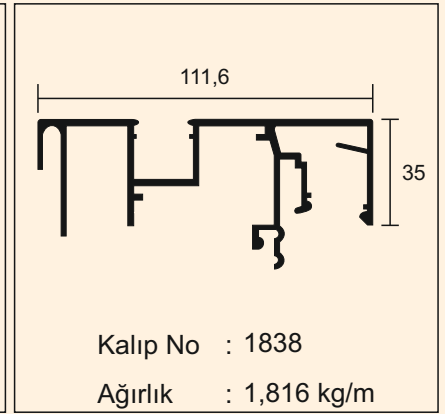
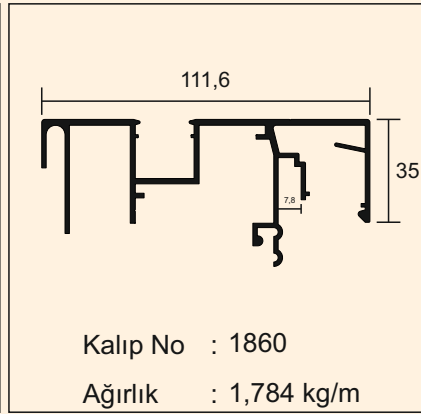
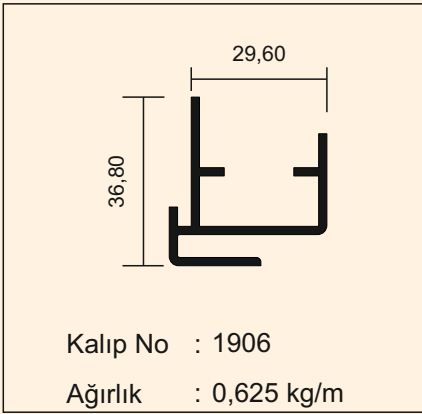
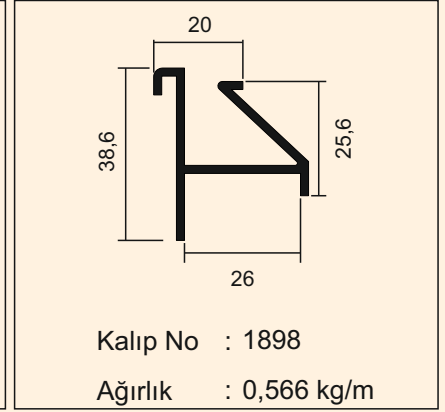
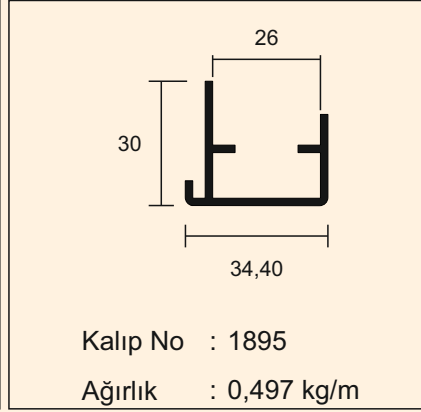
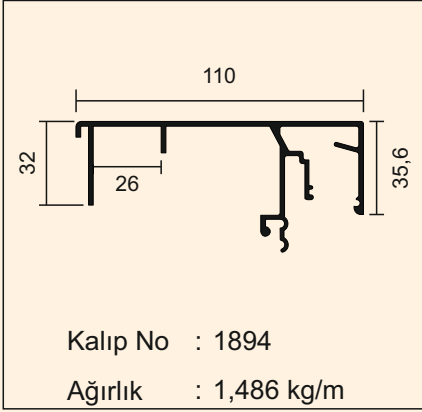

Katalogumuzda bulunan profil çizimleri örnek olarak konulmuştur. Müşterilerimize ait olan çizimlerin profilleri satılamaz. Çizimler üzerinden ölçü almayınız. Resimlerin altında yer alan profil ağırlığı bilgi amaçlı olup, ürünlerin teslim anındaki tartımız ağırlığı geçerlidir.

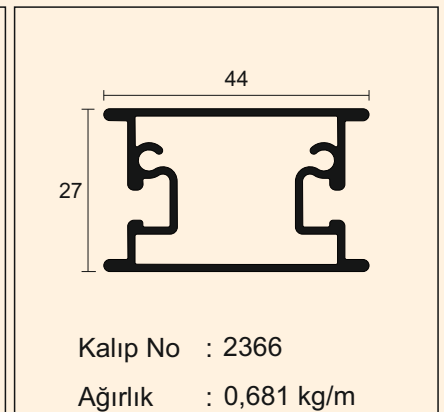
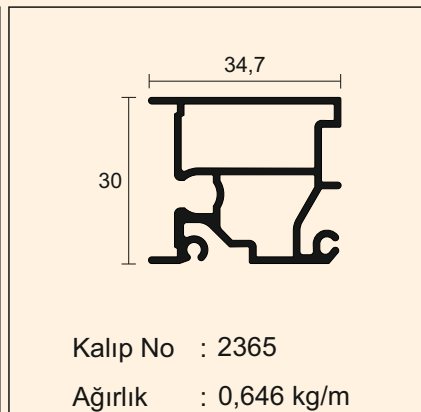
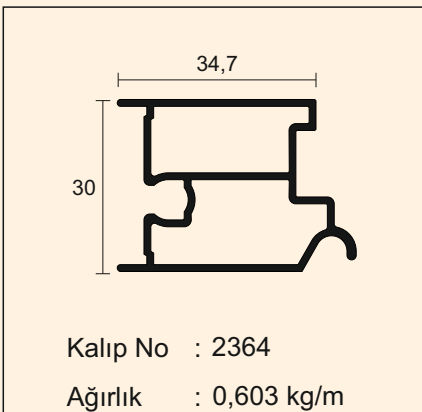
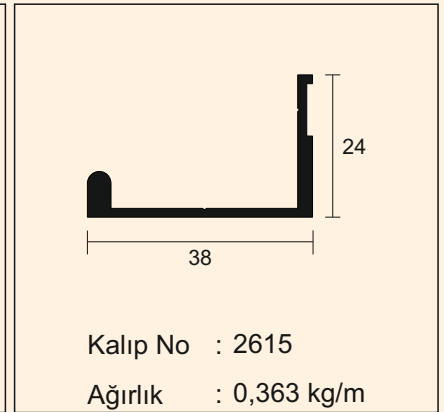
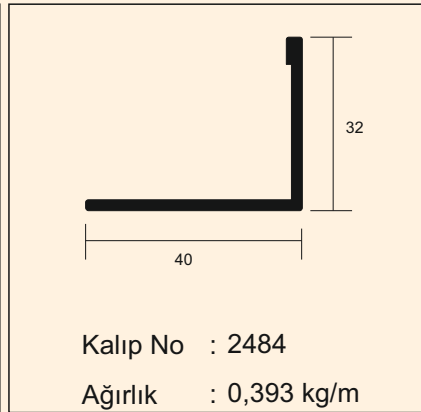
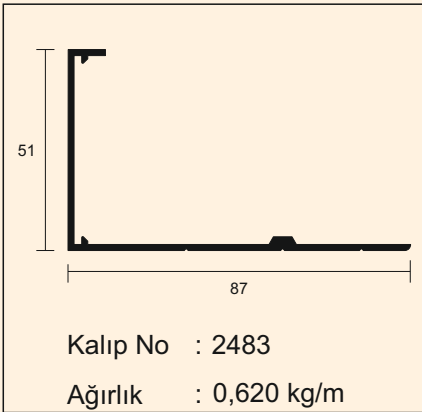
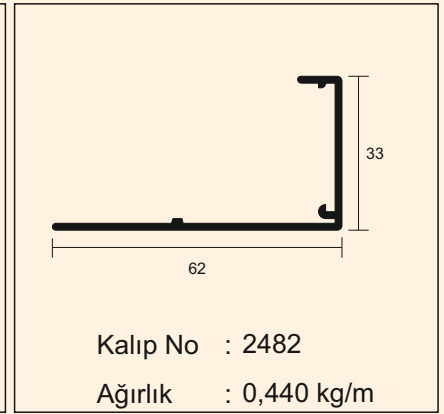
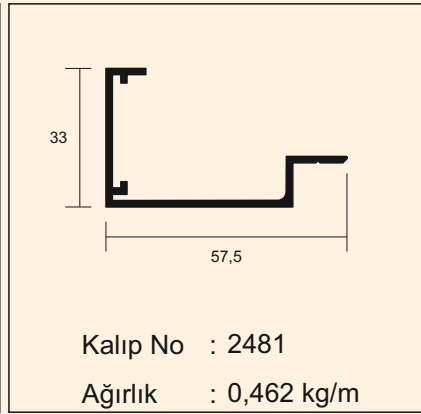
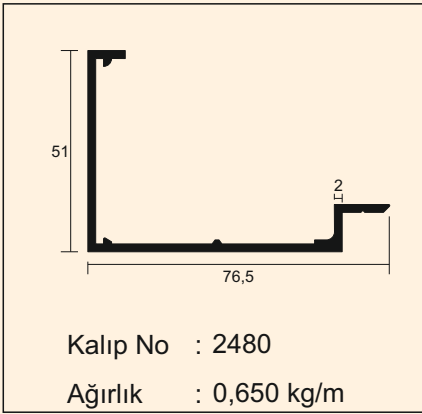
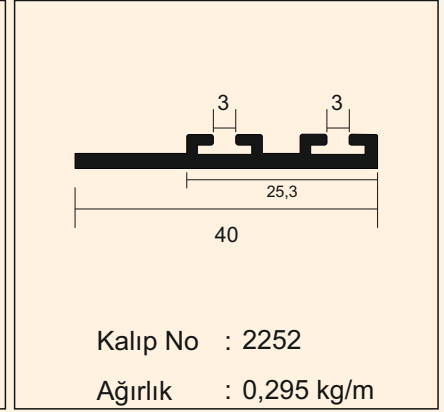
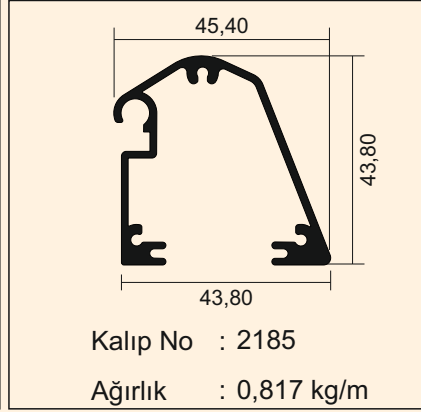
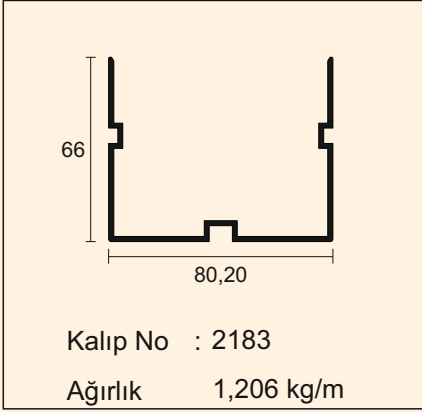

Katalogumuzda bulunan profil çizimleri örnek olarak konulmuştur. Müşterilerimize ait olan çizimlerin profilleri satılamaz. Çizimler üzerinden ölçü almayınız. Resimlerin altında yer alan profil ağırlığı bilgi amaçlı olup, ürünlerin teslim anındaki tartımız ağırlığı geçerlidir.

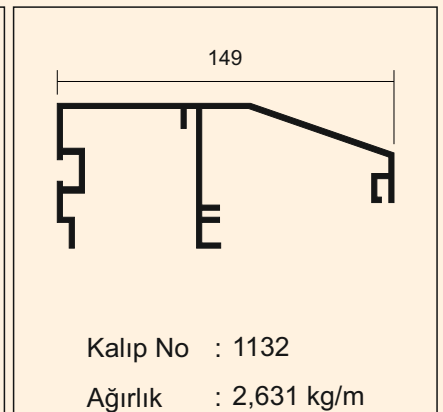
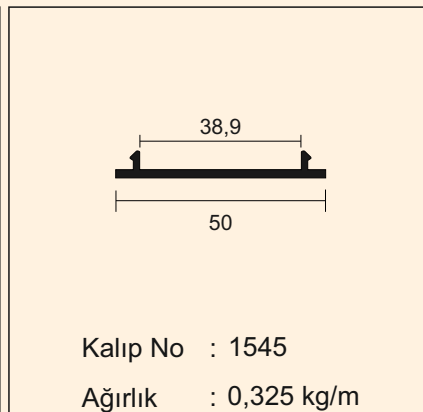
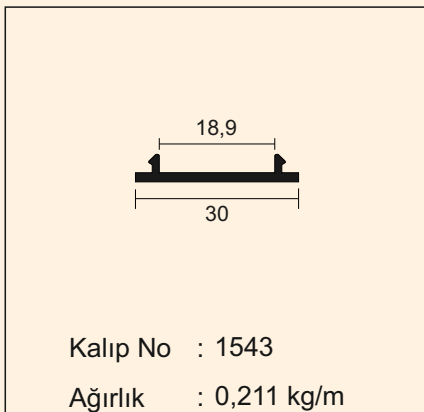
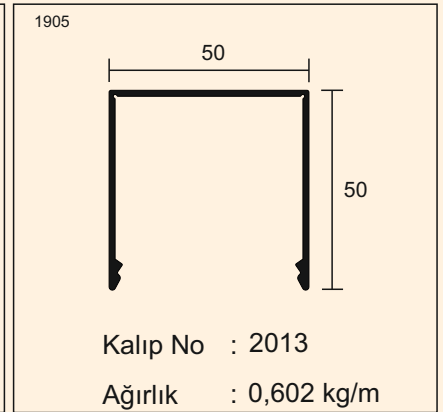
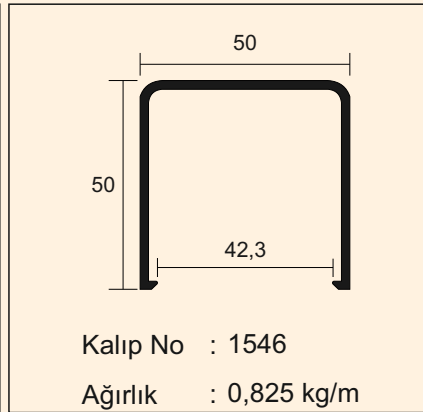
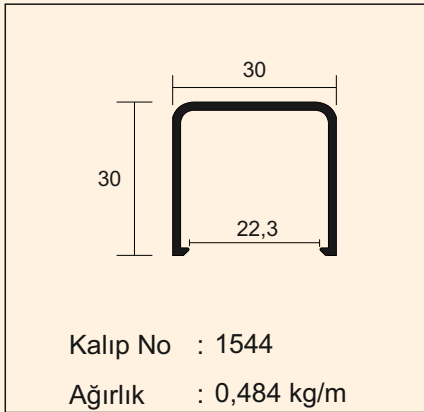
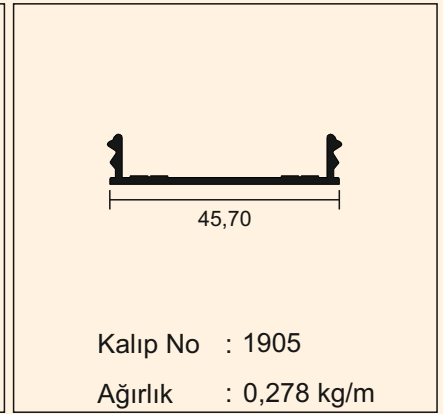
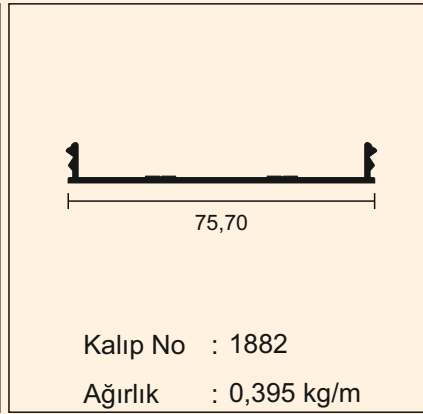
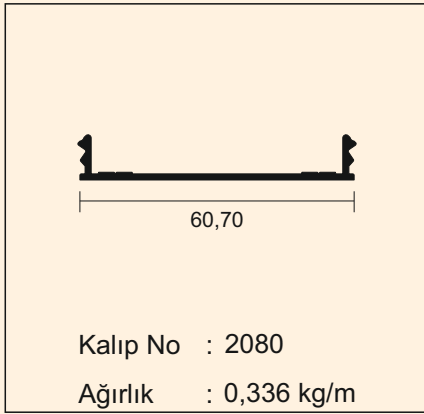
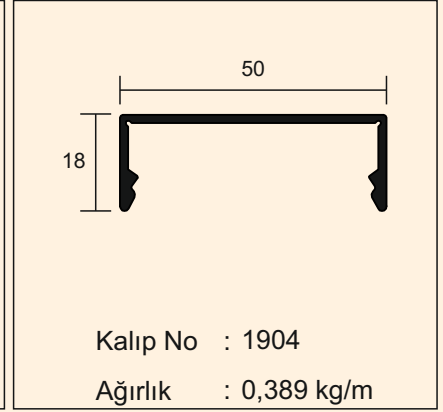
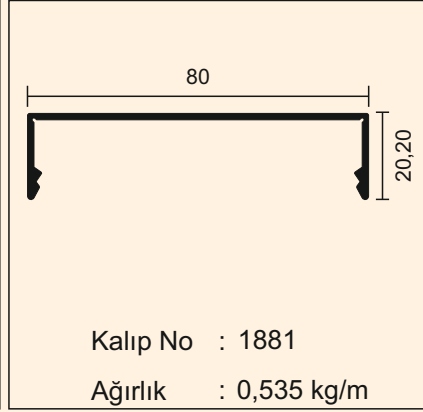
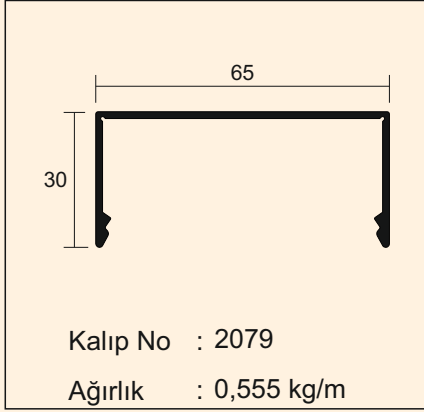

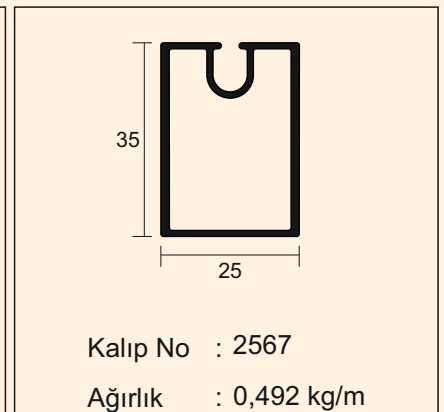
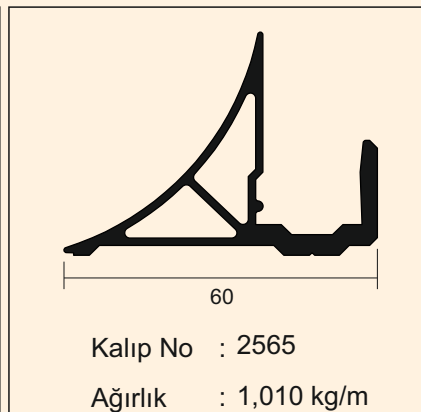
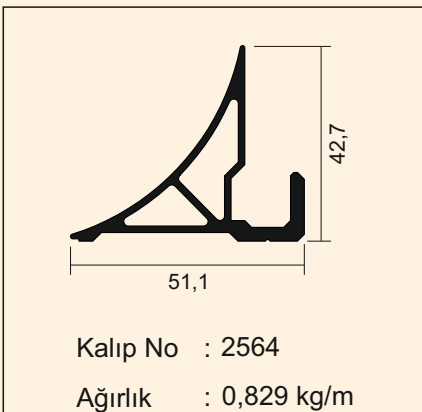
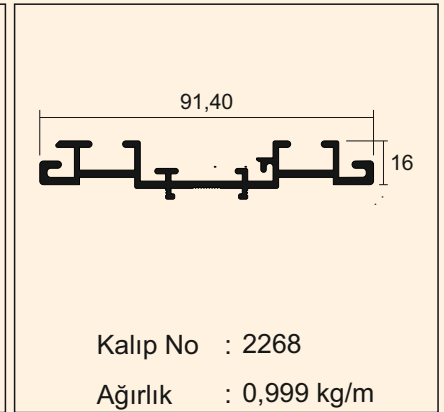
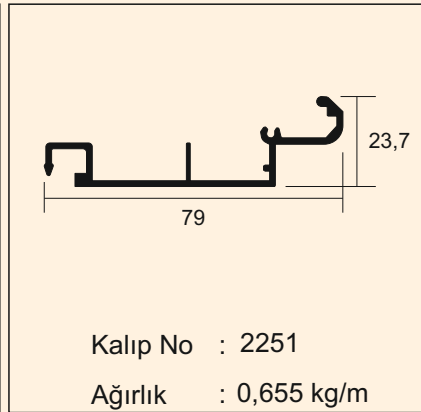
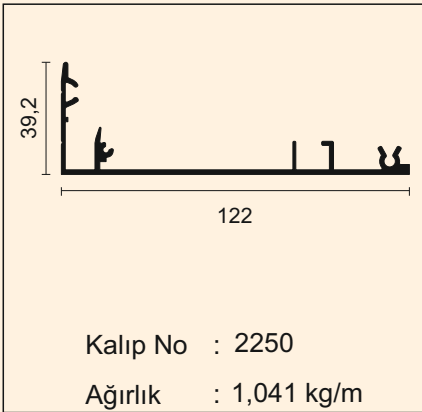
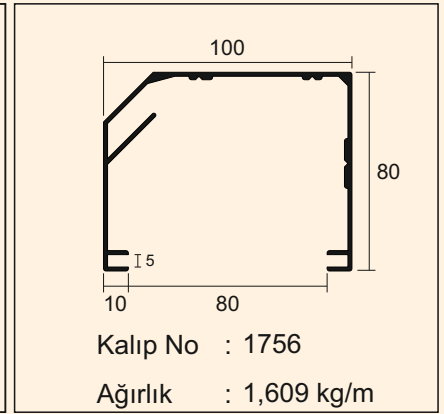
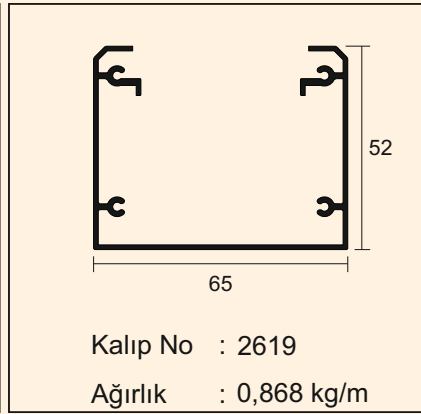
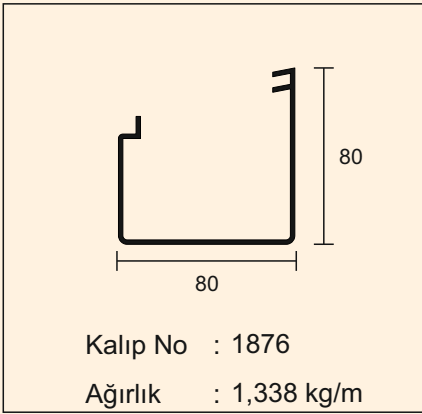
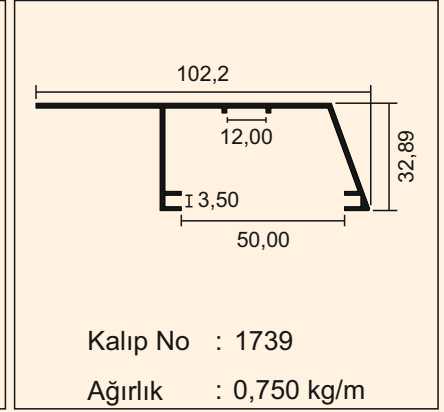
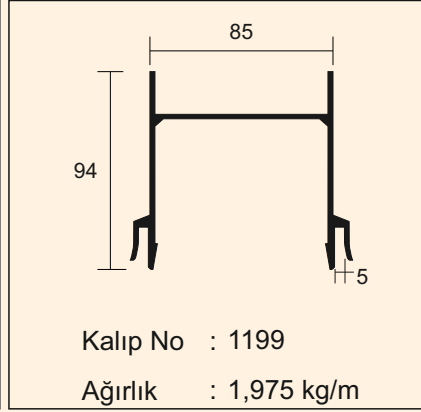
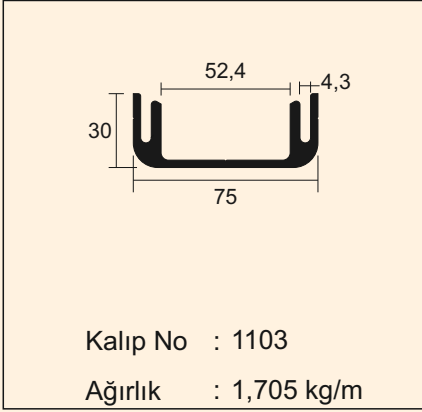

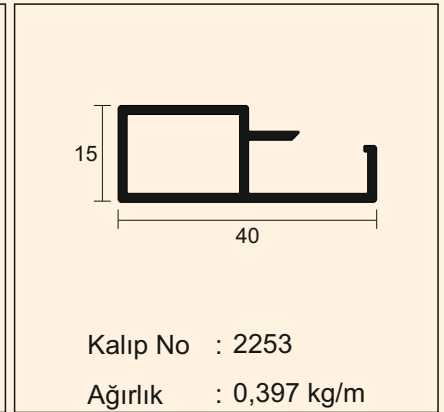
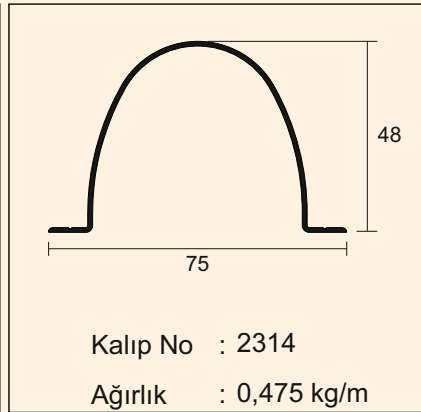
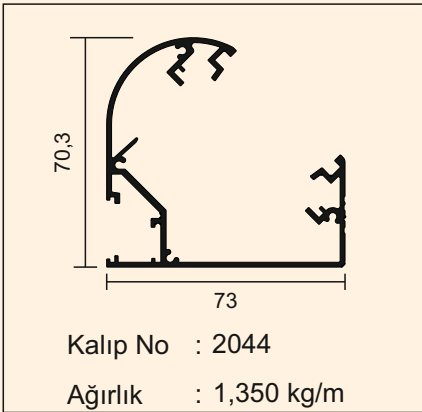
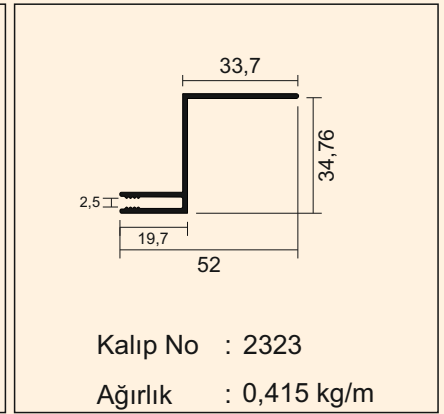
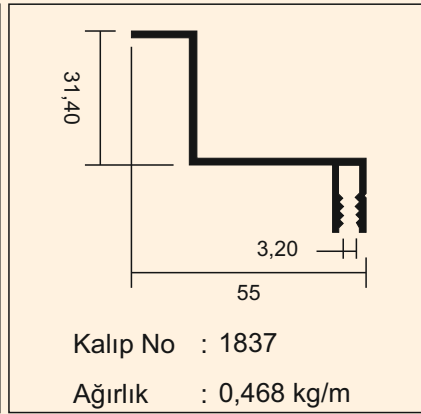
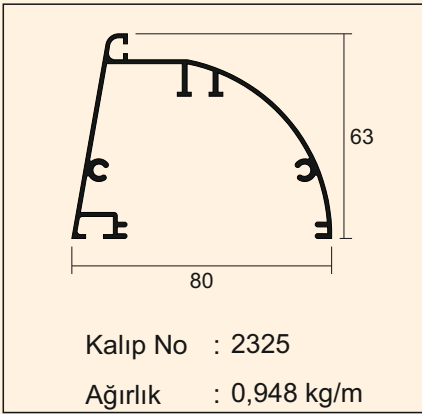
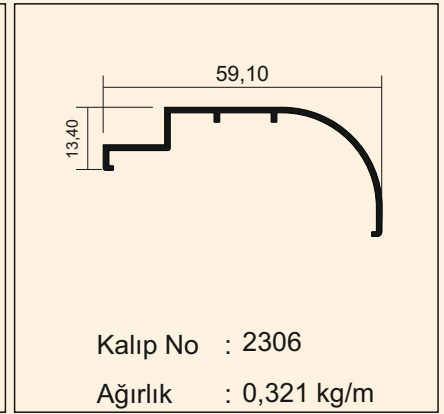
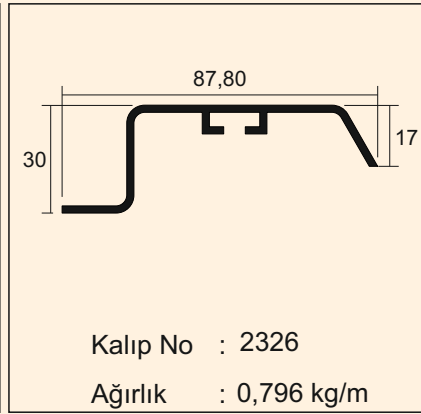
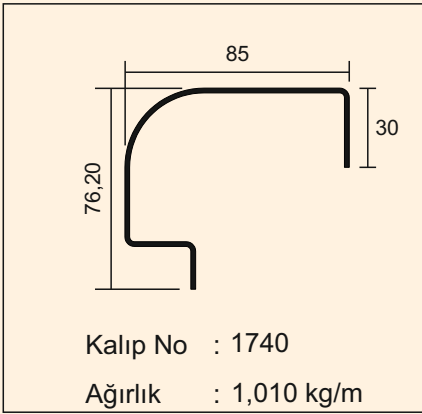
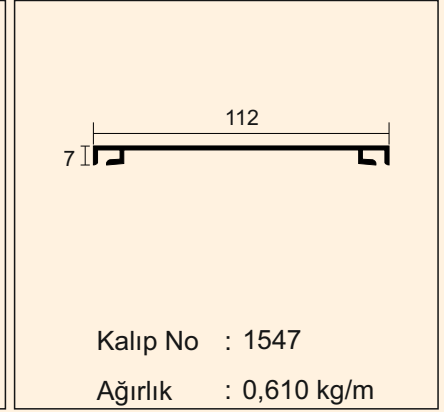
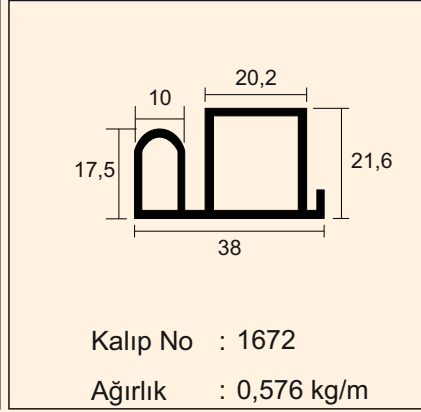
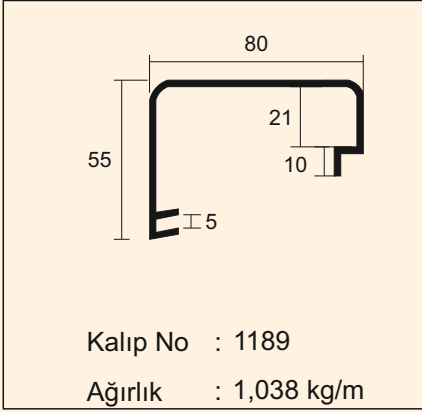

Katalogumuzda bulunan profil çizimleri örnek olarak konulmuştur. Müşterilerimize ait olan çizimlerin profilleri satılamaz. Çizimler üzerinden ölçü almayınız. Resimlerin altında yer alan profil ağırlığı bilgi amaçlı olup, ürünlerin teslim anındaki tartımız ağırlığı geçerlidir.

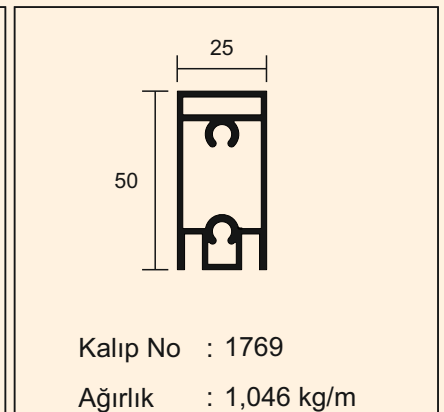
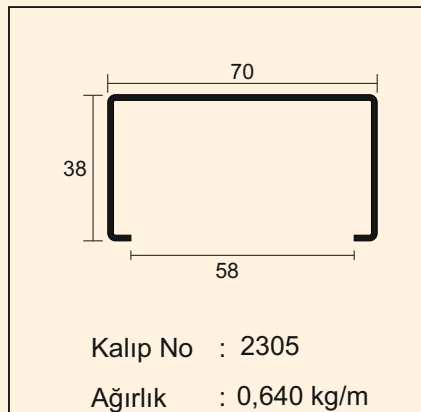
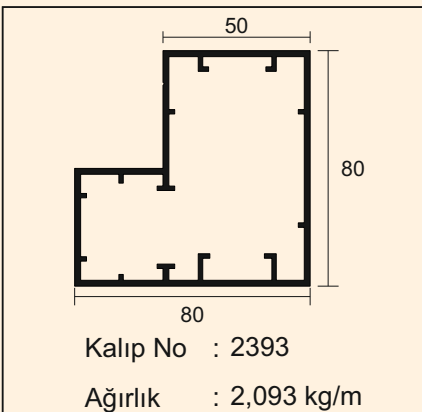
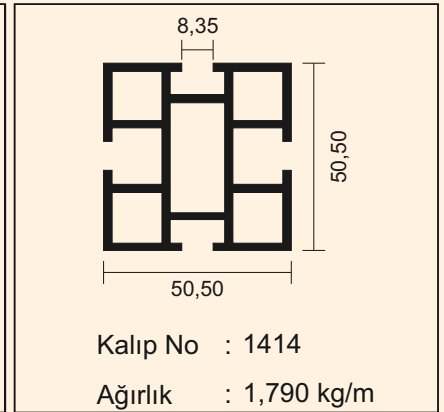
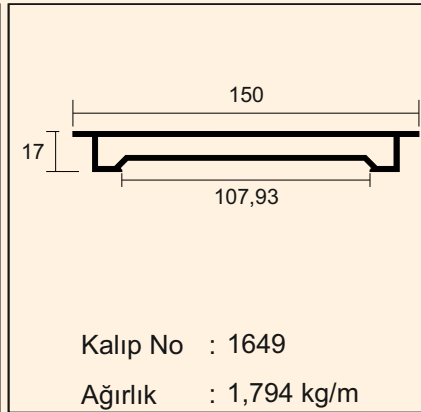
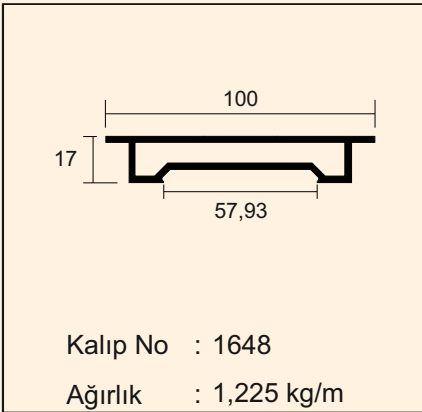
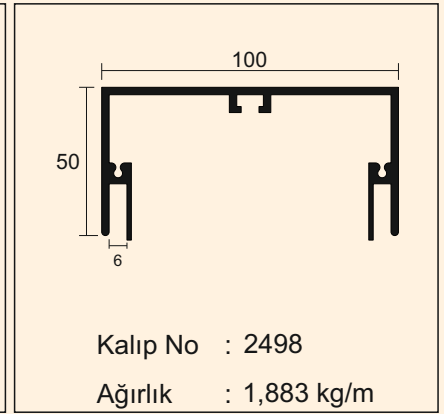
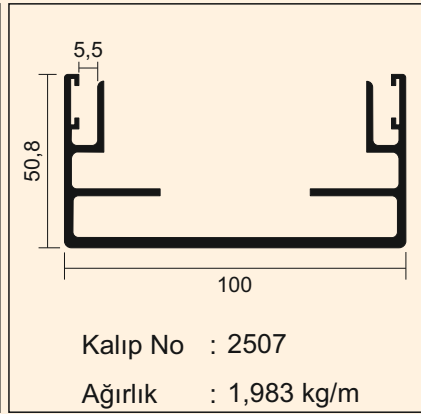
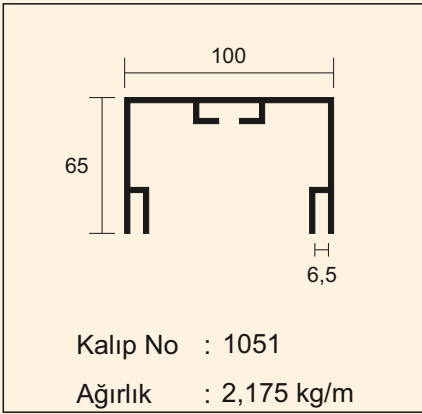
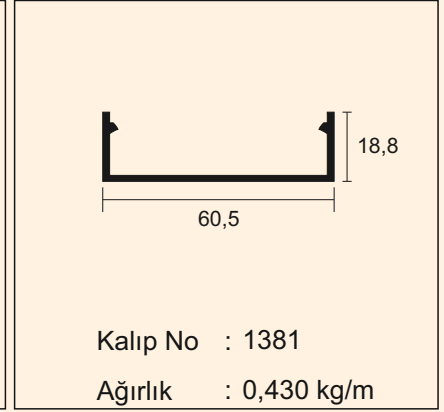
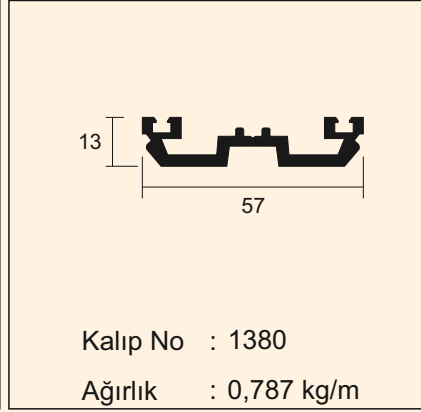
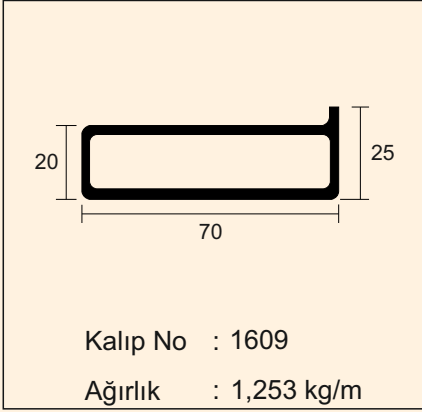

Katalogumuzda bulunan profil çizimleri örnek olarak konulmuştur. Müşterilerimize ait olan çizimlerin profilleri satılamaz. Çizimler üzerinden ölçü almayınız. Resimlerin altında yer alan profil ağırlığı bilgi amaçlı olup, ürünlerin teslim anındaki tartımız ağırlığı geçerlidir.

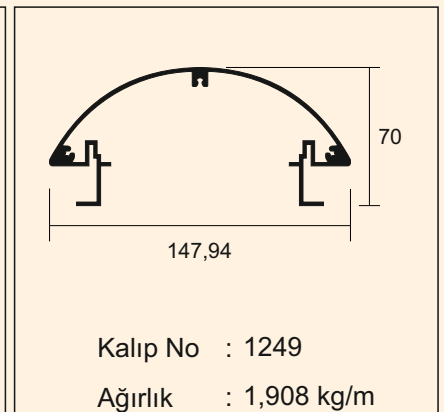
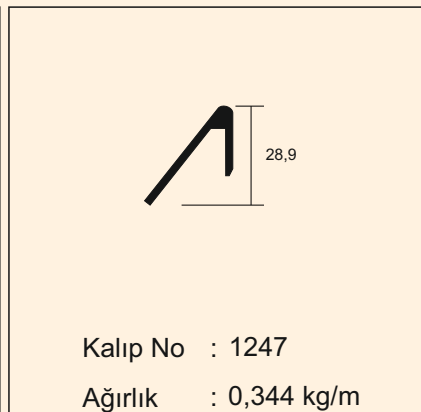
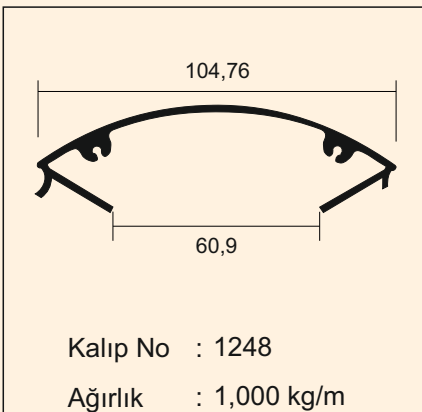
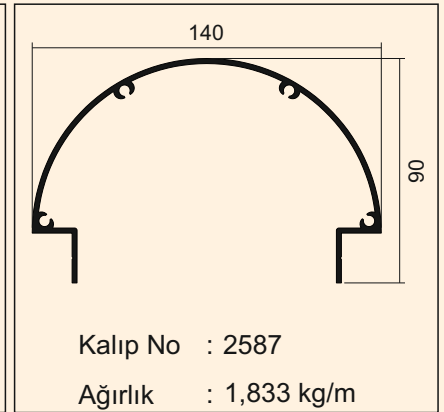
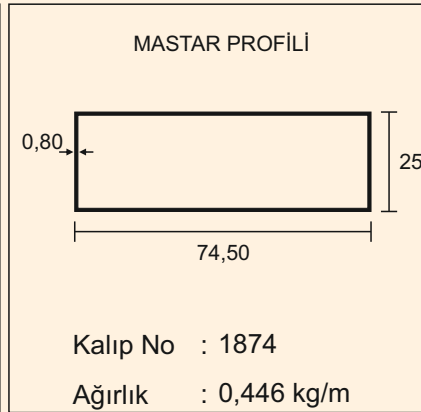
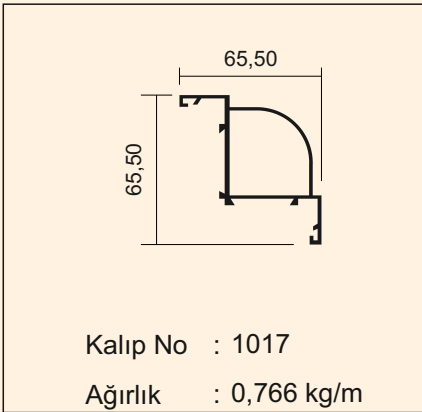
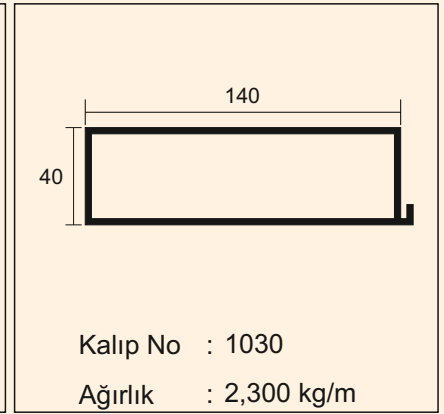
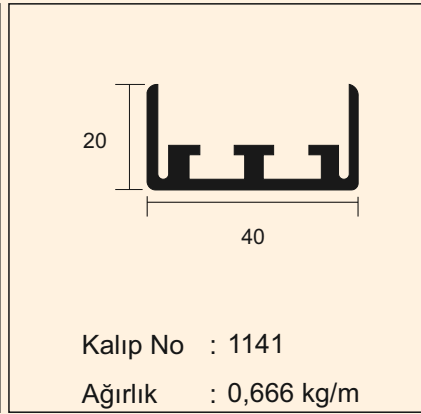
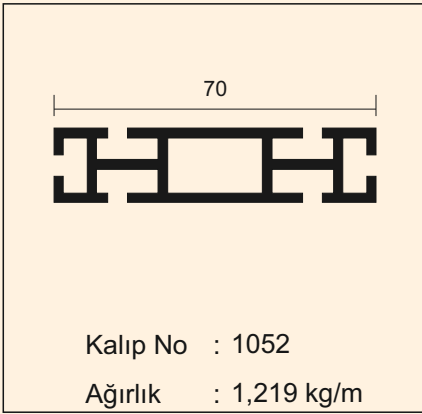
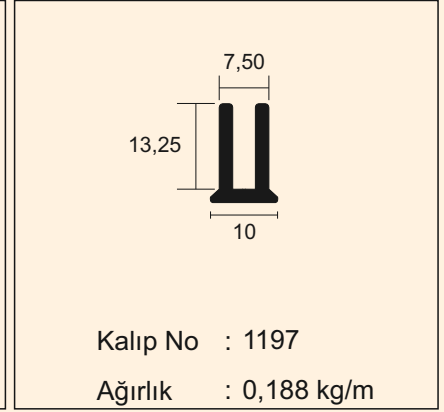
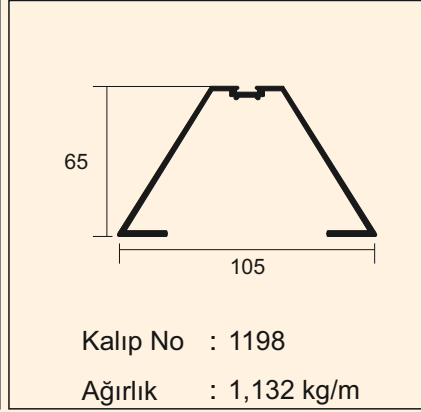
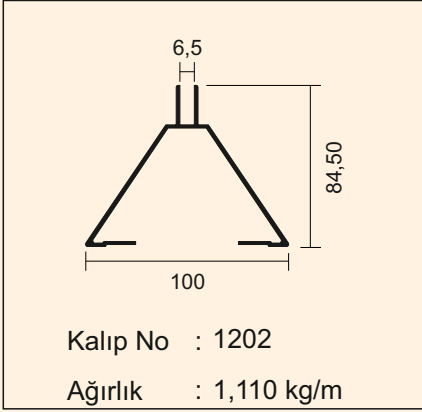

Kataloğumuzda bulunan profil çizimleri örnek olarak konulmuştur. Müşterilerimize ait olan çizimlerin profilleri satılamaz. Çizimler üzerinden ölçü almayınız. Resimlerin altında yer alan profil ağırlığı bilgi amaçlı olup, ürünlerin teslim anındaki tartımız ağırlığı geçerlidir.

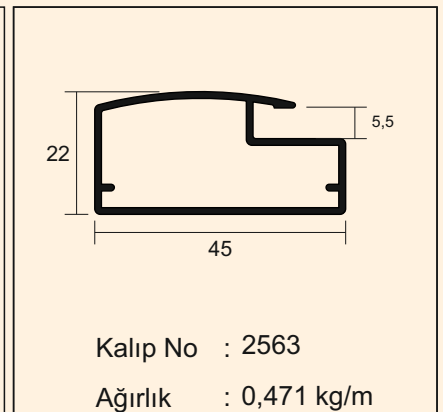
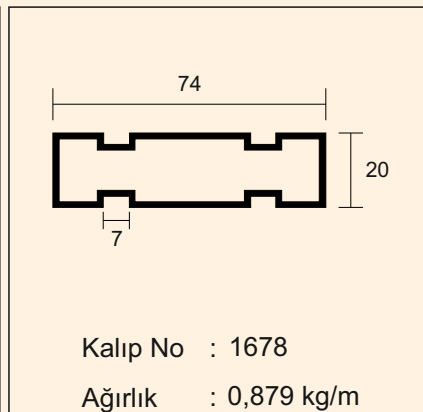
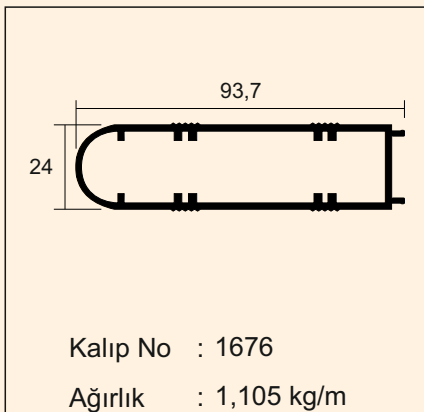
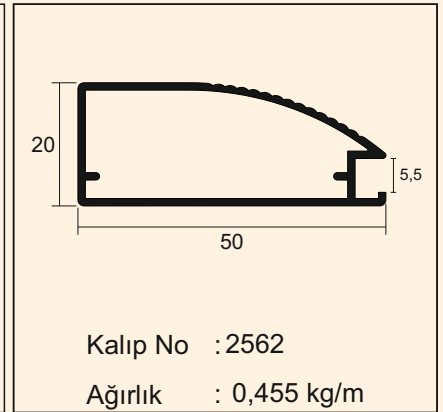
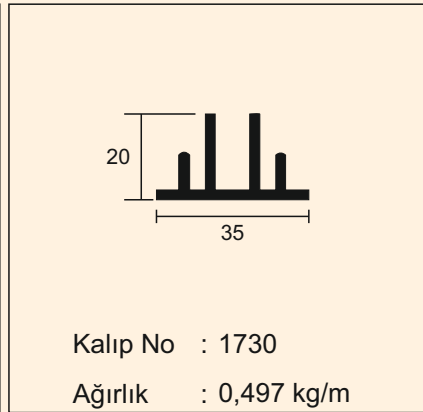
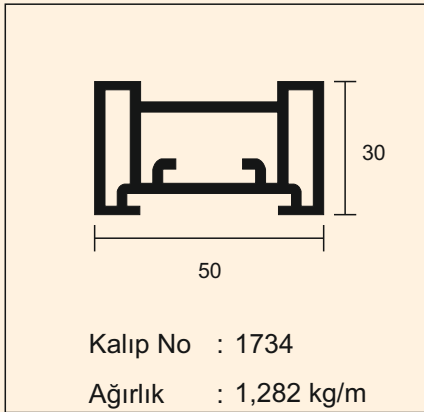
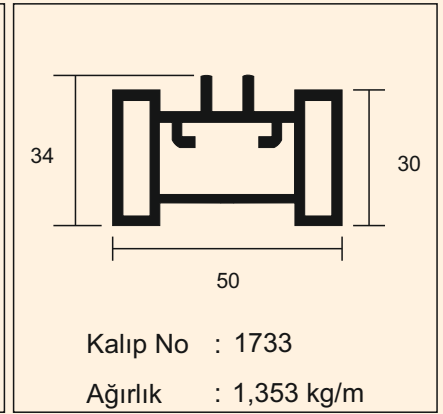
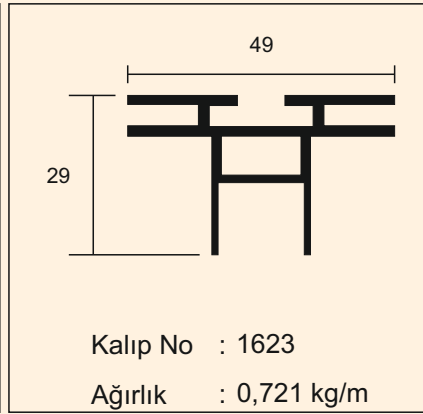
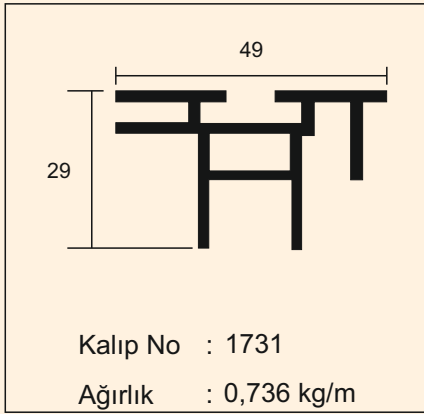
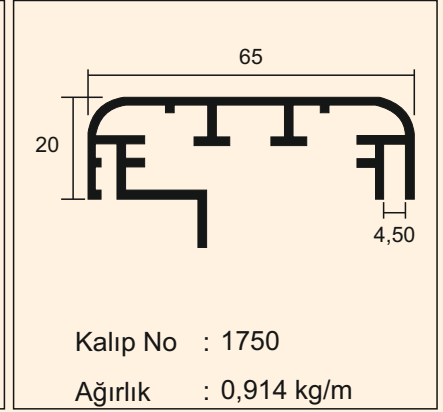
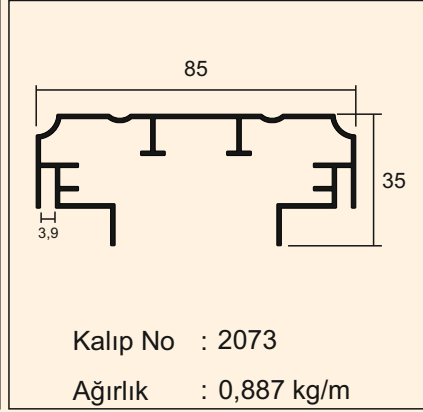
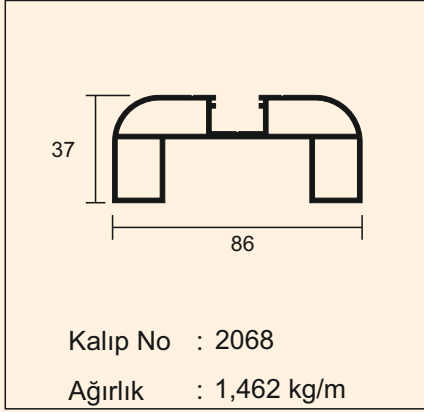

Katalogumuzda bulunan profil çizimleri örnek olarak konulmuştur. Müşterilerimize ait olan çizimlerin profilleri satılamaz. Çizimler üzerinden ölçü almayınız. Resimlerin altında yer alan profil ağırlığı bilgi amaçlı olup, ürünlerin teslim anındaki tartımız ağırlığı geçerlidir.

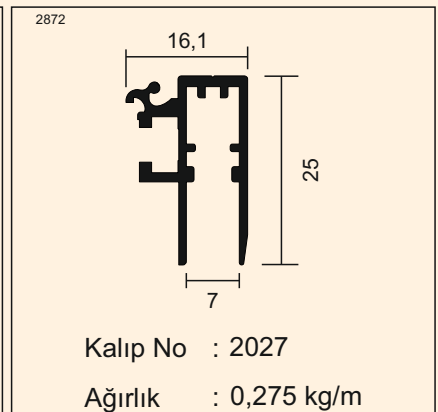
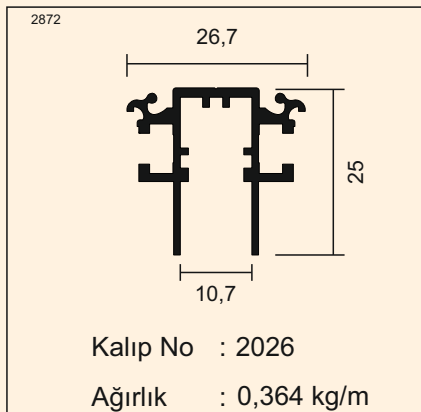
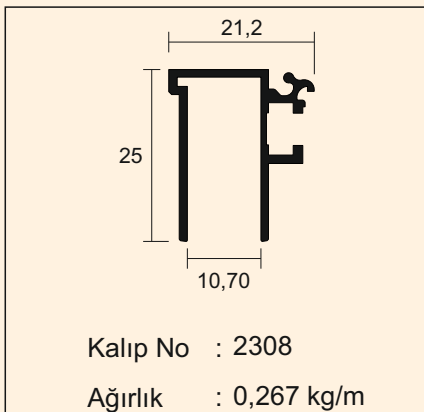
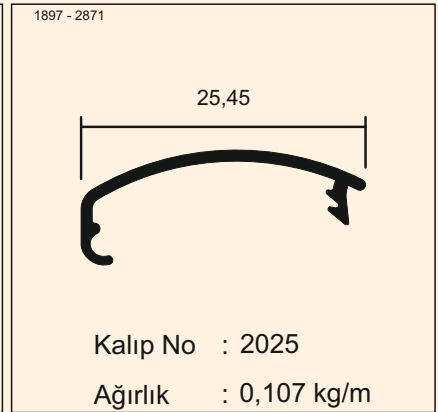
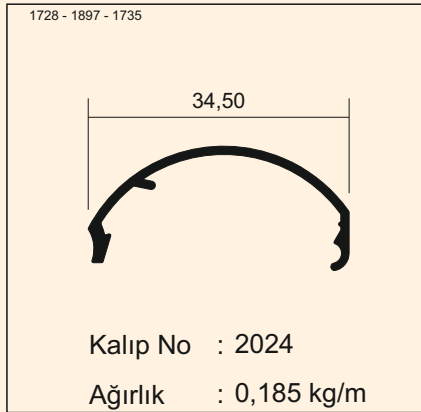
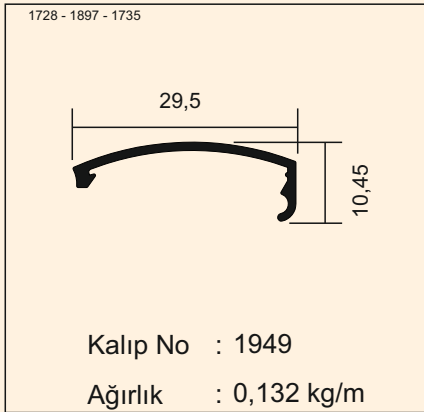
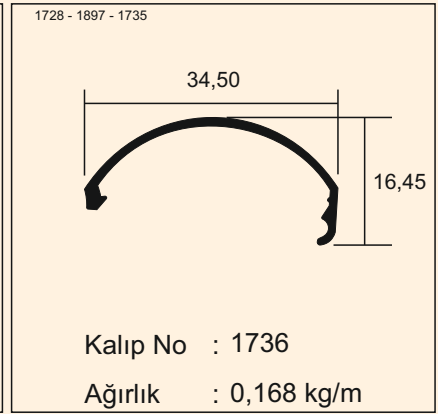
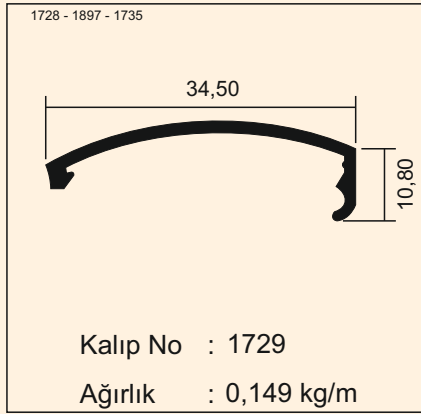
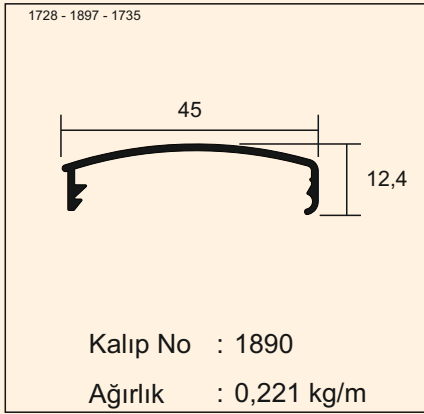
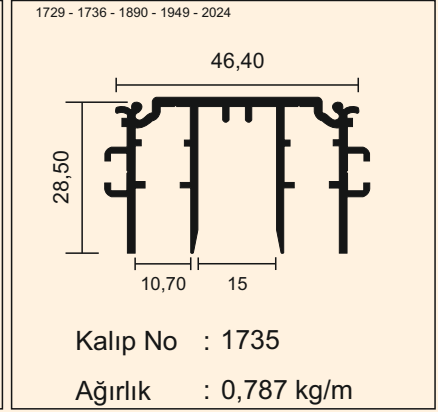
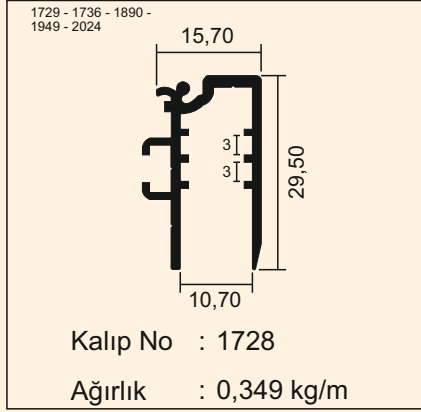
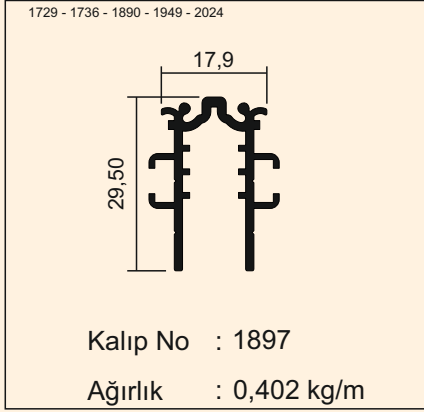

Kataloğumuzda bulunan profil çizimleri örnek olarak konulmuştur. Müşterilerimize ait olan çizimlerin profilleri satılamaz. Çizimler üzerinden ölçü almayınız. Resimlerin altında yer alan profil ağırlığı bilgi amaçlı olup, ürünlerin teslim anındaki tartımız ağırlığı geçerlidir.

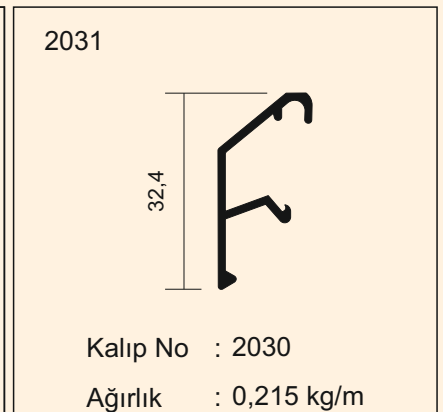
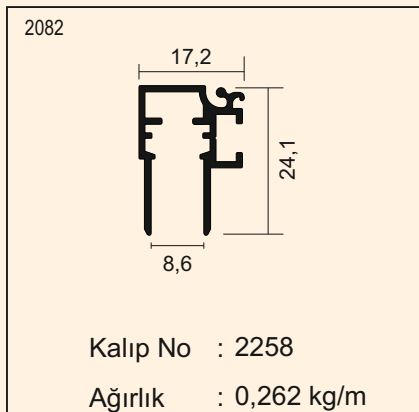
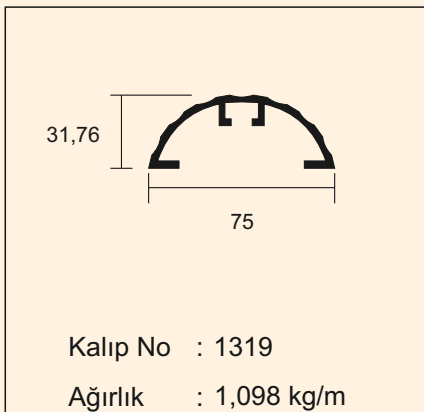
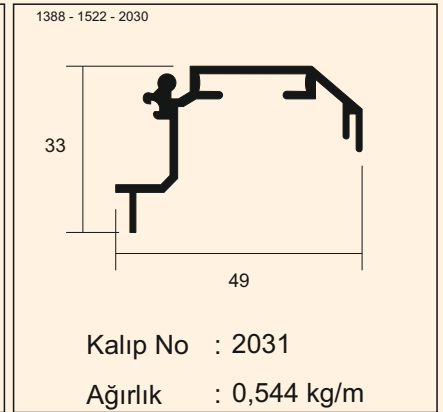
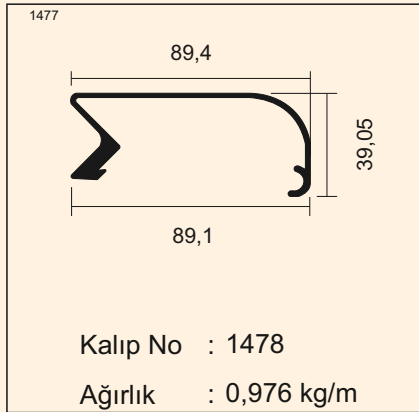
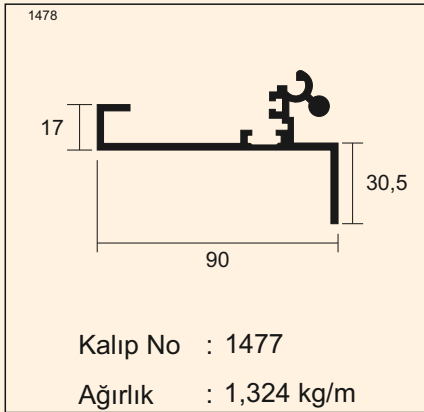
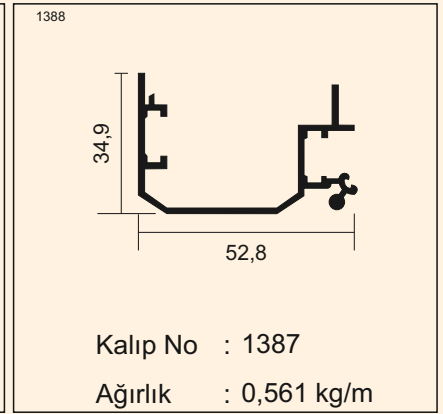
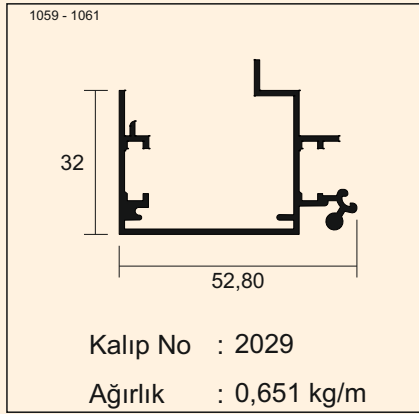
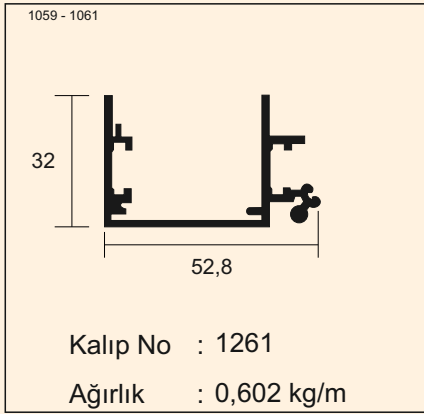
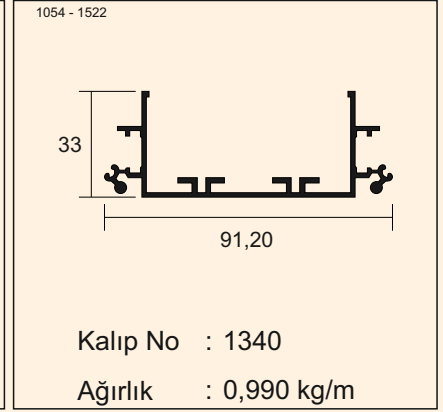
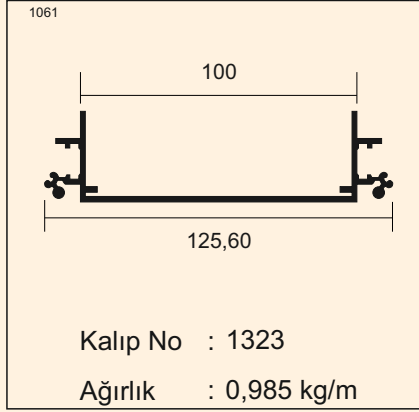
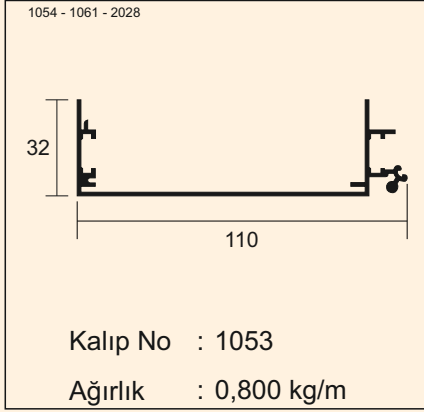

Katalogumuzda bulunan profil çizimleri örnek olarak konulmuştur. Müşterilerimize ait olan çizimlerin profilleri satılamaz. Çizimler üzerinden ölçü almayınız. Resimlerin altında yer alan profil ağırlığı bilgi amaçlı olup, ürünlerin teslim anındaki tartımız ağırlığı geçerlidir.

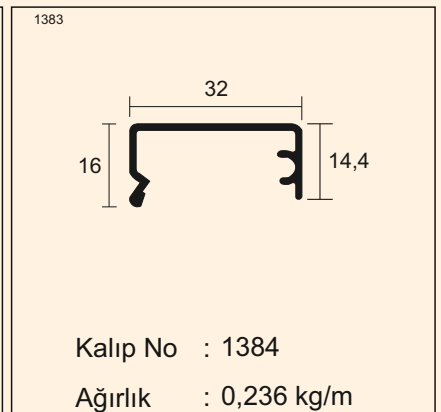
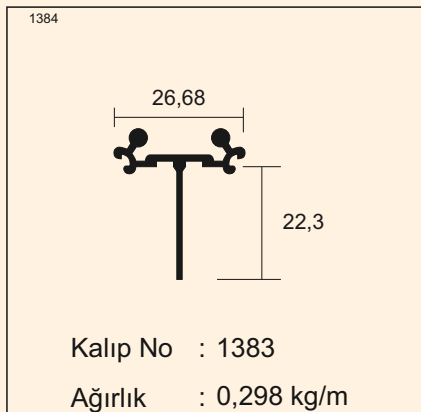
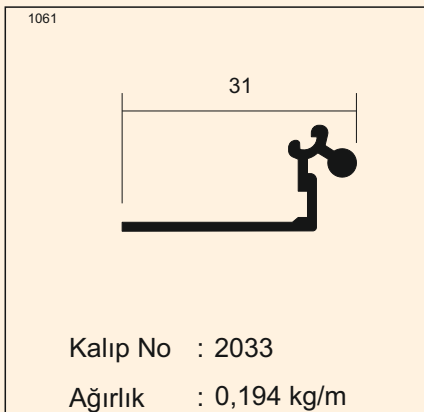
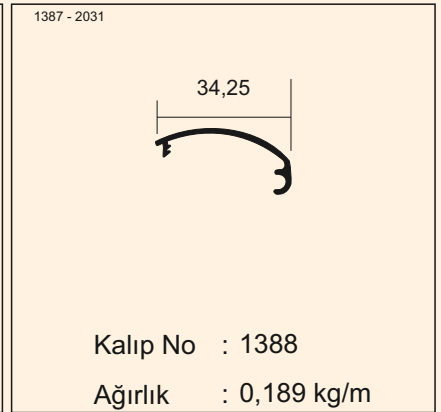
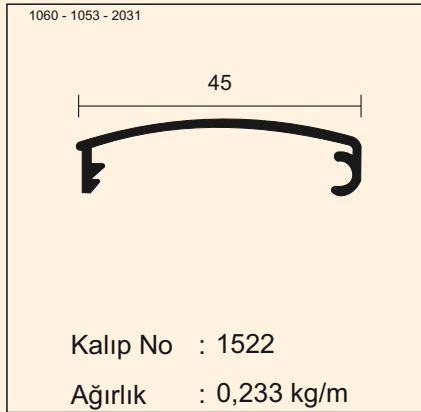
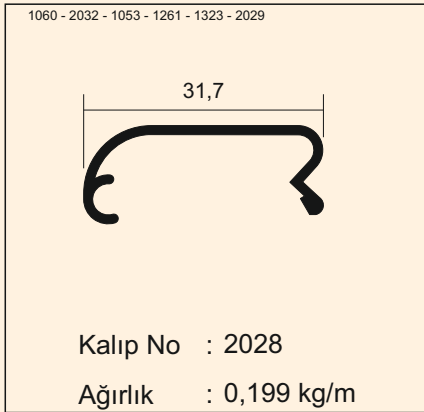
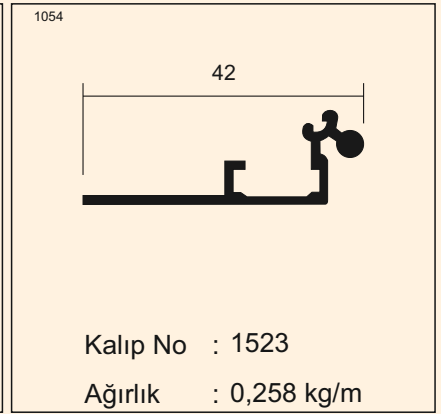
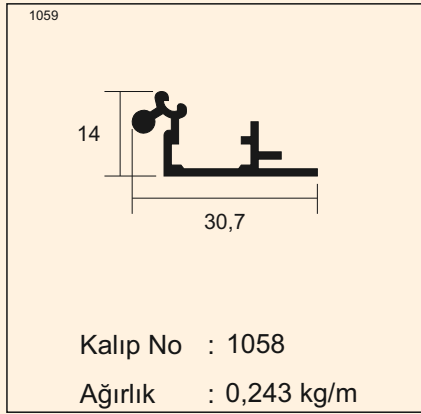
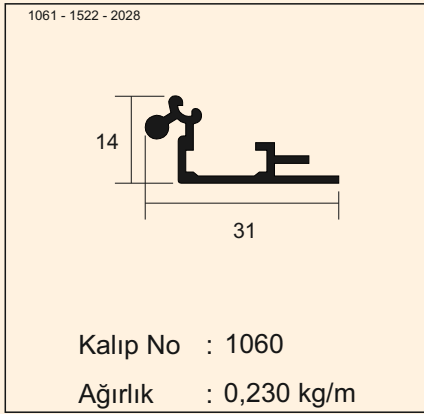
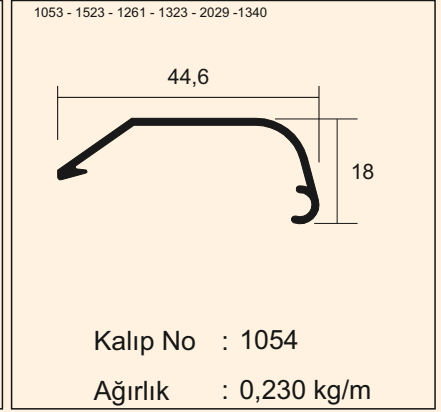
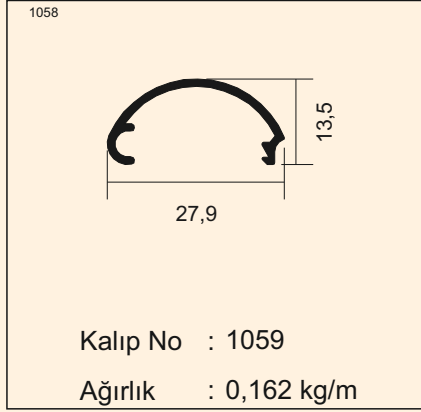
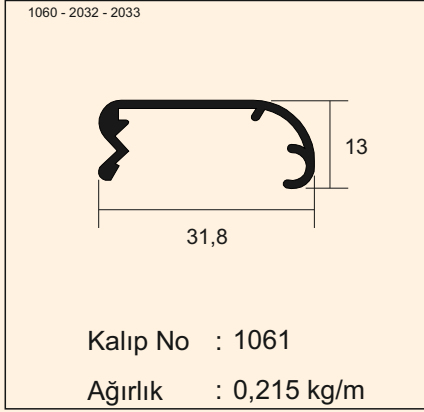

Katalogumuzda bulunan profil çizimleri örnek olarak konulmuştur. Müşterilerimize ait olan çizimlerin profilleri satılamaz. Çizimler üzerinden ölçü almayınız. Resimlerin altında yer alan profil ağırlığı bilgi amaçlı olup, ürünlerin teslim anındaki tartımız ağırlığı geçerlidir.

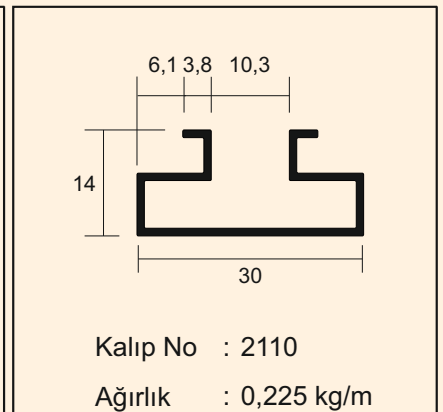
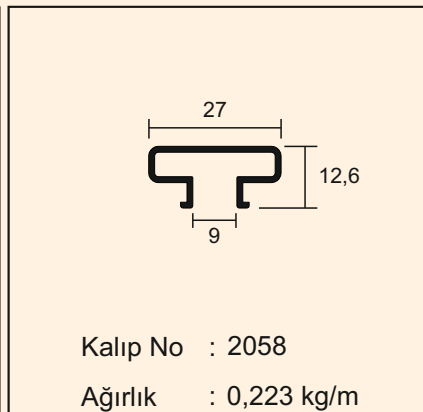
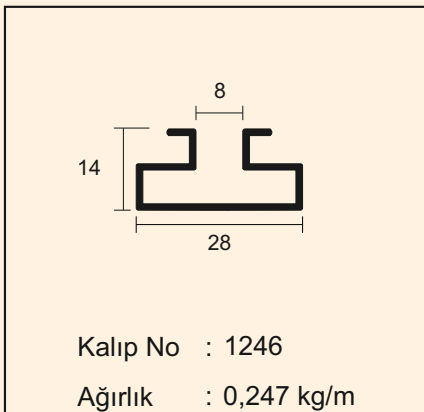
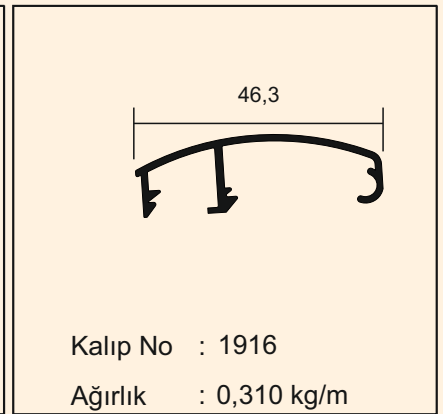
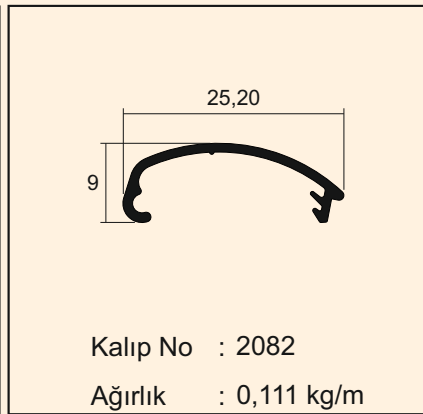
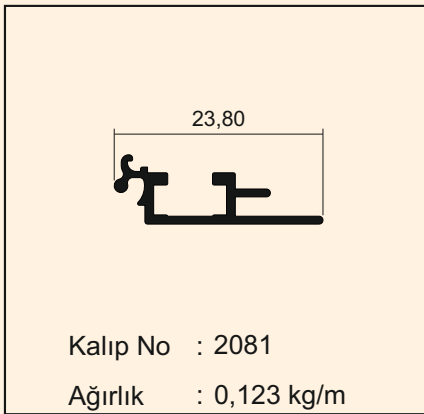
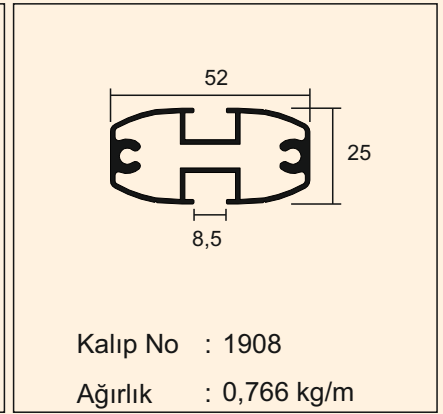
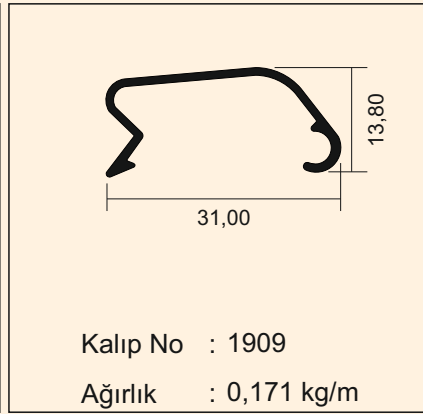
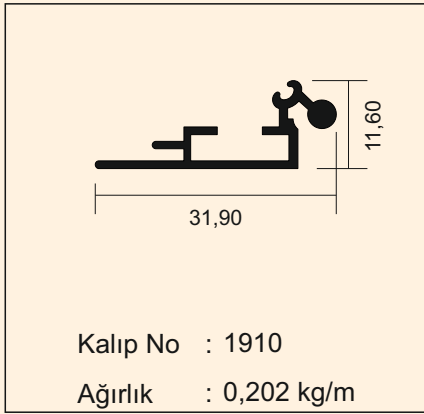
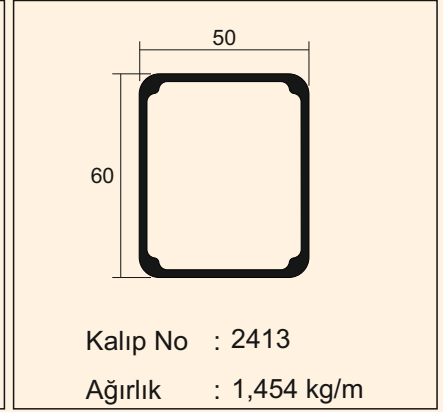
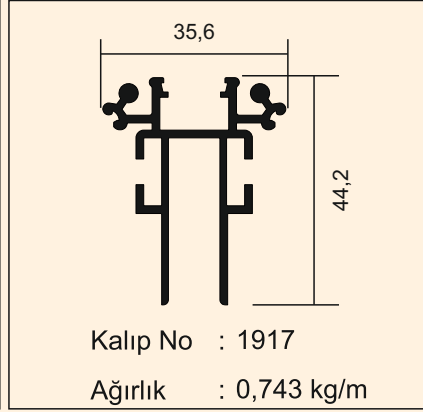
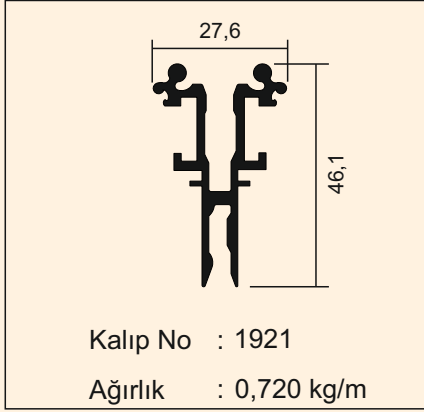

Kataloğumuzda bulunan profil çizimleri örnek olarak konulmuştur. Müşterilerimize ait olan çizimlerin profilleri satılamaz. Çizimler üzerinden ölçü almayınız. Resimlerin altında yer alan profil ağırlığı bilgi amaçlı olup, ürünlerin teslim anındaki tartımız ağırlığı geçerlidir.

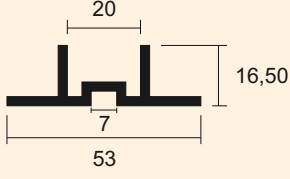

Kalıp No : 1087

Ağırlık : 0,633 kg/m

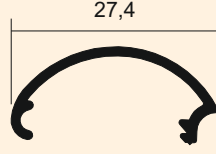

Kalıp No : 2785

Ağırlık : 0,157 kg/m

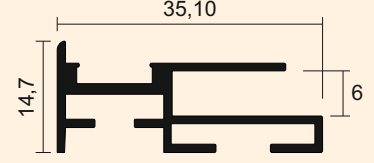

Kalıp No : 2246

Ağırlık : 0,327 kg/m

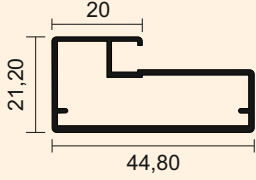

Kalıp No : 2236

Ağırlık : 0,494 kg/m

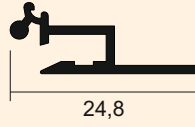

Kalıp No : 1528

Ağırlık : 0,145 kg/m

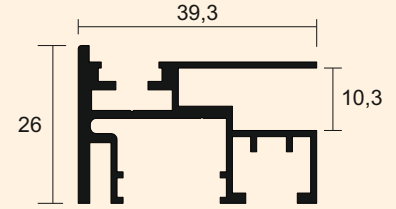

Kalıp No : 2309

Ağırlık : 0,605 kg/m

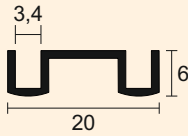

Kalıp No : 2328

Ağırlık : 0,108 kg/m

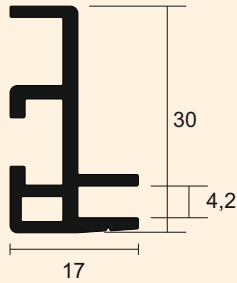

Kalıp No : 2320

Ağırlık : 0,410 kg/m

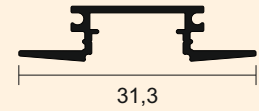

Kalıp No : 2256

Ağırlık : 0,138 kg/m

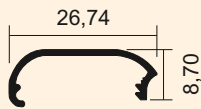

Kalıp No : 1183

Ağırlık : 0,121 kg/m

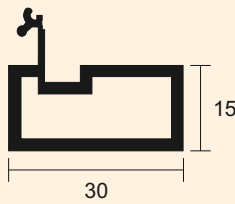

Kalıp No : 1182

Ağırlık : 0,543 kg/m

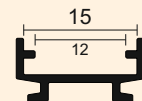

Kalıp No : 2261

Ağırlık : 0,104 kg/m

1394

41

Kalıp No : 1393
Ağırlık : 0,292 kg/m

1753

29,30
42,70
6
8,20

Kalıp No : 1752
Ağırlık : 0,519 kg/m

1752

13,70
48,00
47,50

Kalıp No : 1753
Ağırlık : 0,226 kg/m

1393

38,3

Kalıp No : 1394
Ağırlık : 0,153 kg/m

2035

38,4

Kalıp No : 2034
Ağırlık : 0,230 kg/m

2034

47,5
45,7

Kalıp No : 2035
Ağırlık : 1,265 kg/m

1386

33,5
47,9

Kalıp No : 1385
Ağırlık : 0,606 kg/m

1258

35,50

Kalıp No : 1257
Ağırlık : 0,161 kg/m

1257

32,60
41,50

Kalıp No : 1258
Ağırlık : 1,038 kg/m

1385

56,1

Kalıp No : 1386
Ağırlık : 0,283 kg/m

1257

41,5
3,2

Kalıp No : 2036
Ağırlık : 1,075 kg/m

4
74
22,9

Kalıp No : 1651
Ağırlık : 0,238 kg/m

Kataloğumuzda bulunan profil çizimleri örnek olarak konulmuştur. Müşterilerimize ait olan çizimlerin profilleri satılamaz. Çizimler üzerinden ölçü almayınız. Resimlerin altında yer alan profil ağırlığı bilgi amaçlı olup, ürünlerin teslim anındaki tartımız ağırlığı geçerlidir.

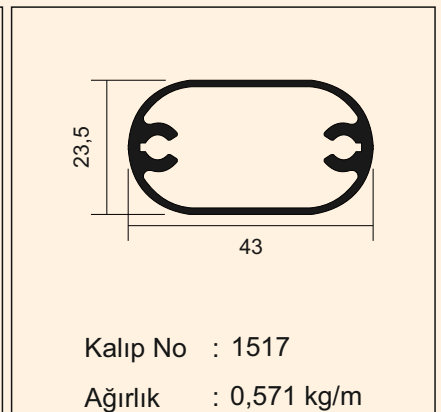
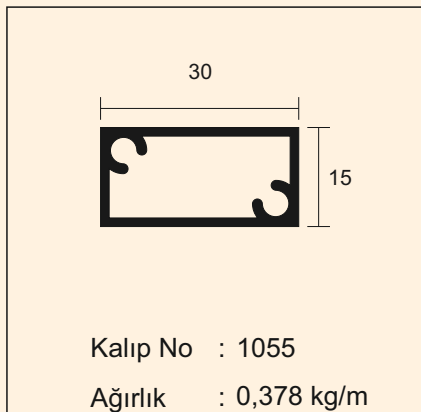
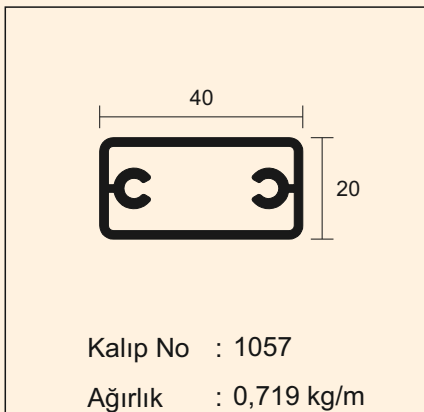
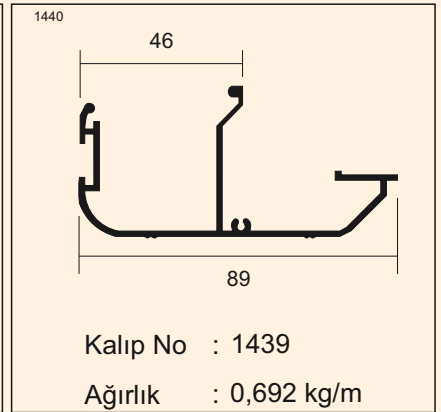
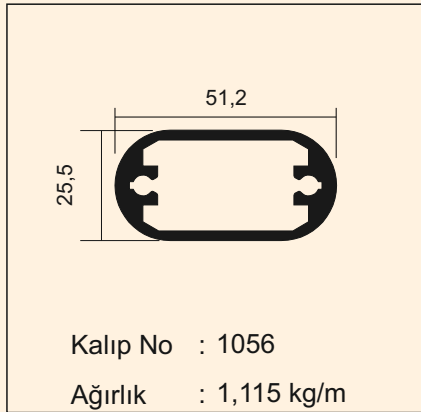
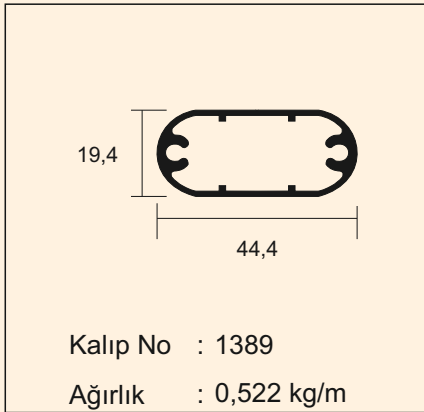
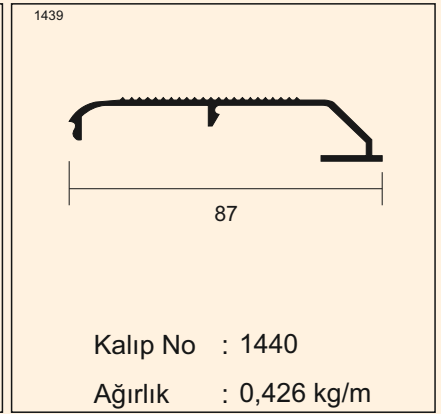
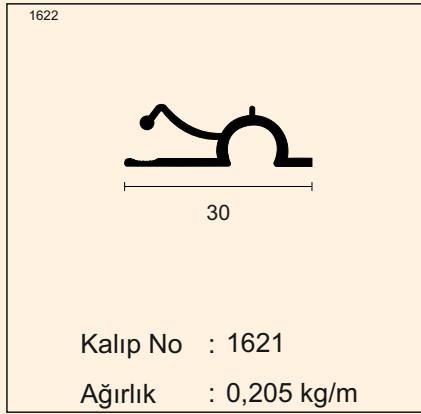
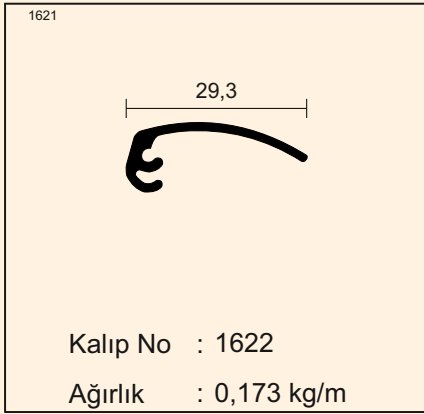
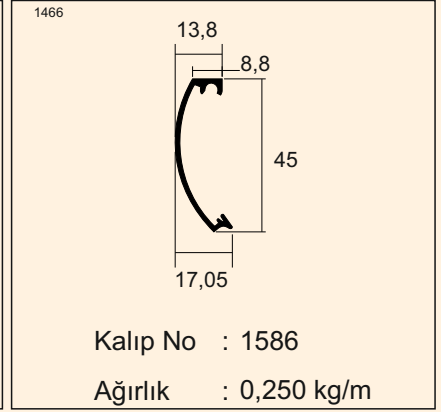
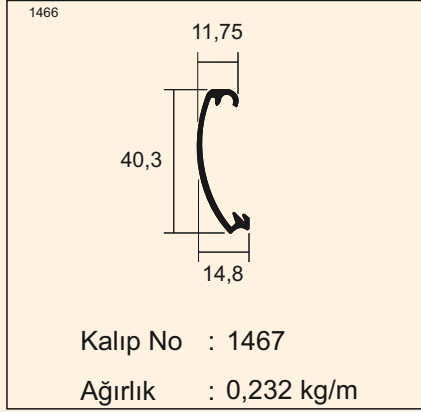
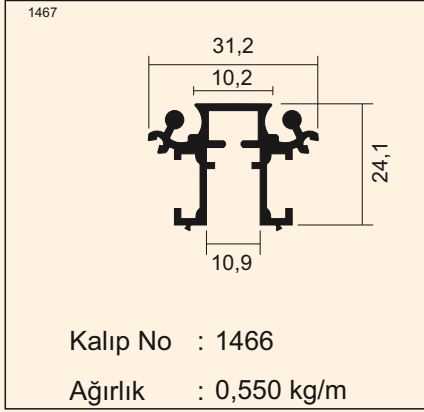

Kataloğumuzda bulunan profil çizimleri örnek olarak konulmuştur. Müşterilerimize ait olan çizimlerin profilleri satılamaz. Çizimler üzerinden ölçü almayınız. Resimlerin altında yer alan profil ağırlığı bilgi amaçlı olup, ürünlerin teslim anındaki tartımız ağırlığı geçerlidir.

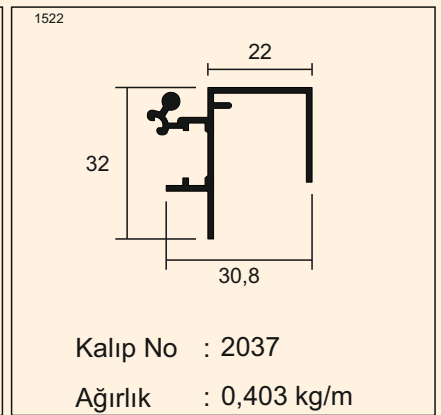
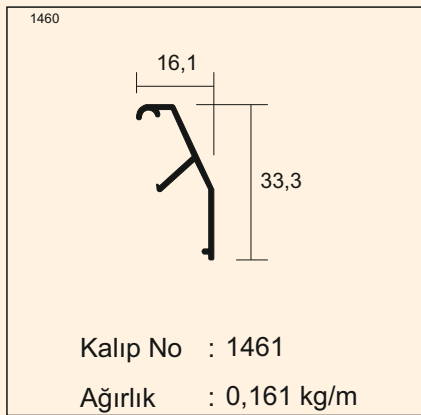
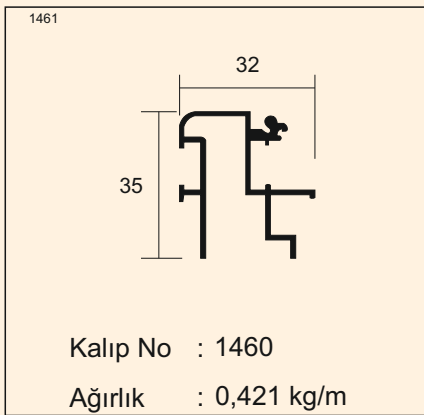
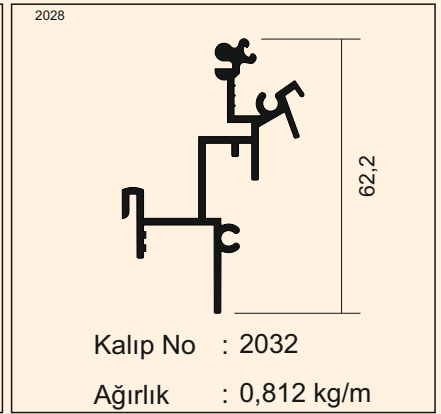
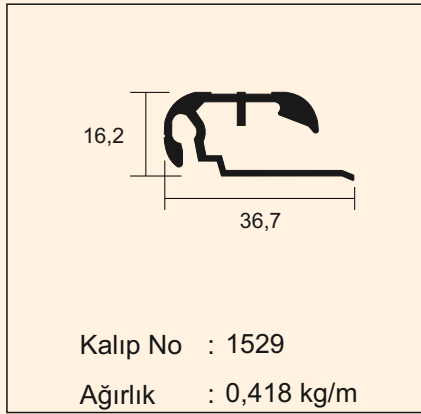
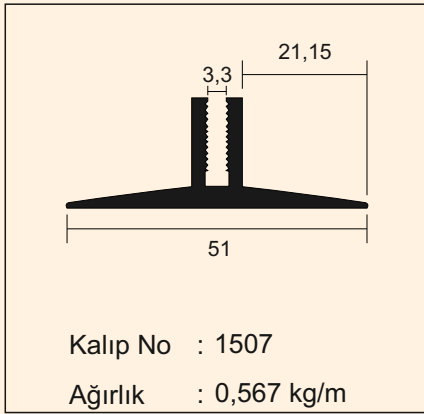
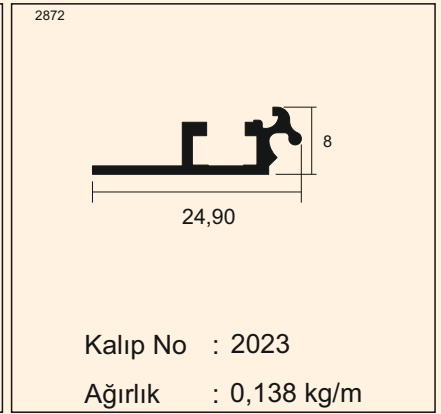
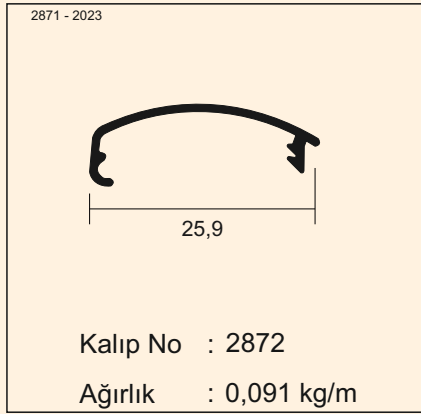
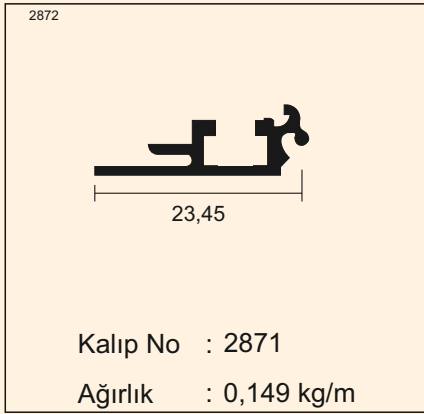
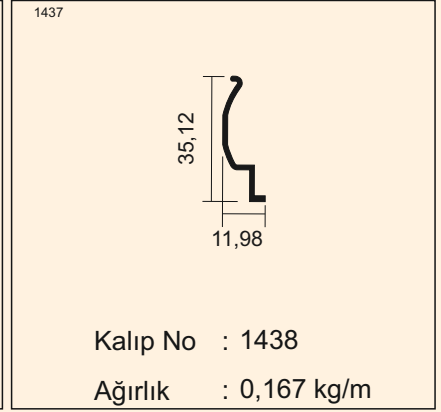
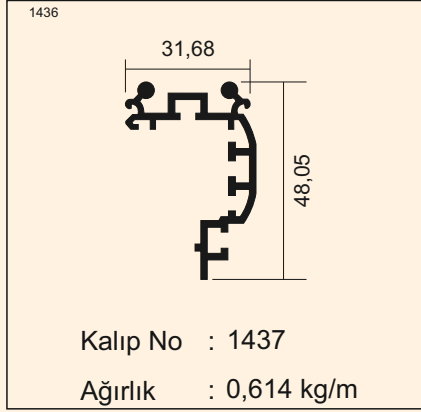
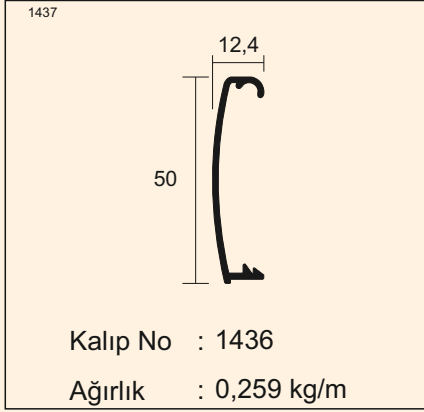

Katalogumuzda bulunan profil çizimleri örnek olarak konulmuştur. Müşterilerimize ait olan çizimlerin profilleri satılamaz. Çizimler üzerinden ölçü almayınız. Resimlerin altında yer alan profil ağırlığı bilgi amaçlı olup, ürünlerin teslim anındaki tartımız ağırlığı geçerlidir.

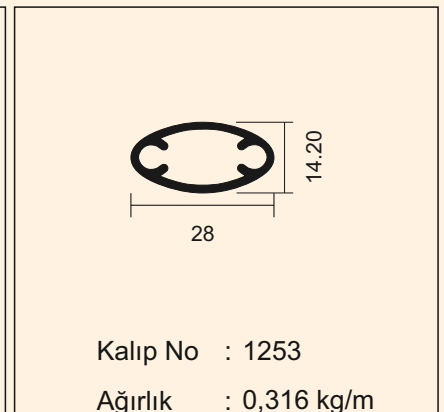
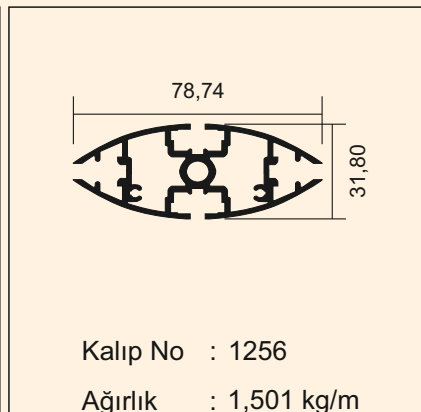
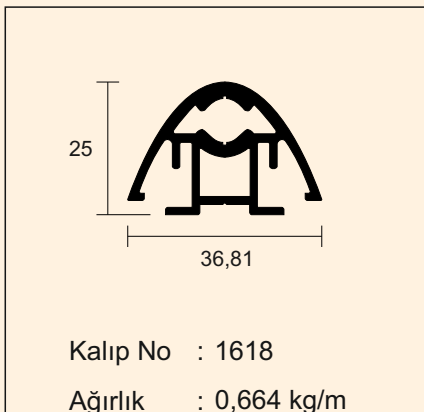
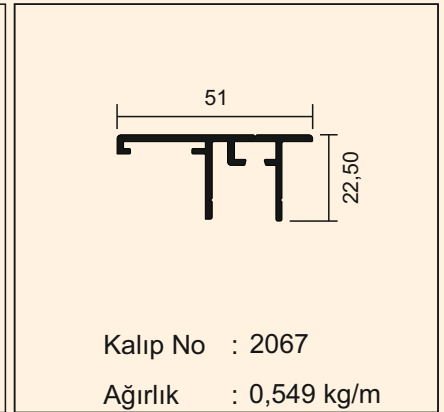
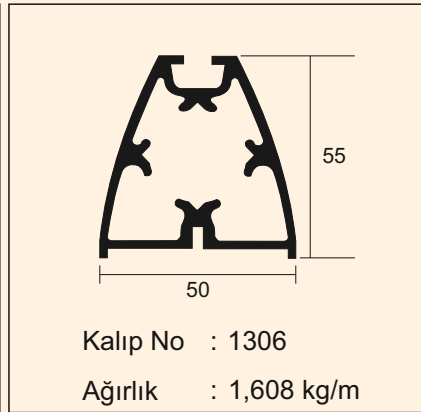
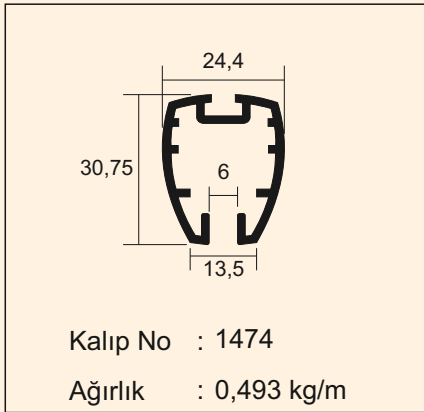
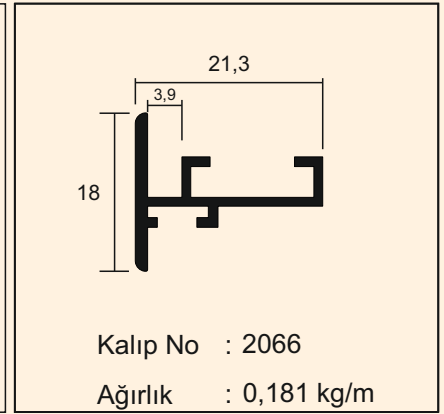
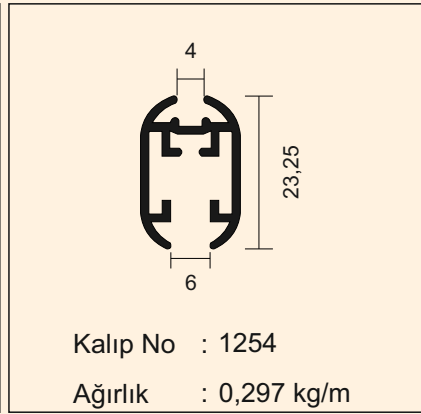
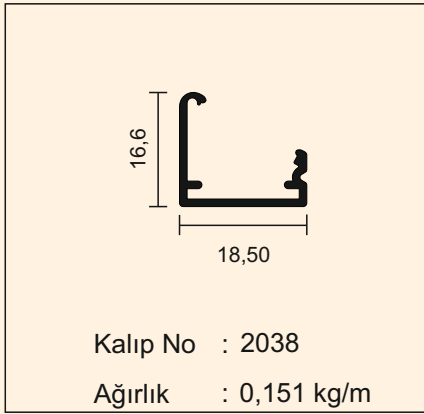
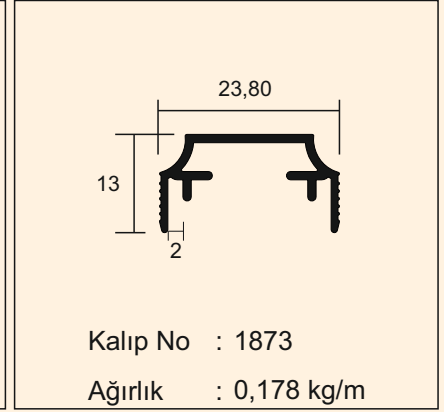
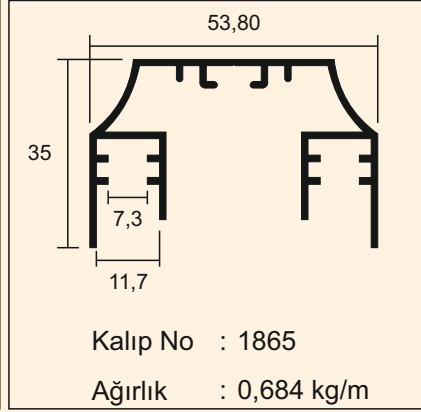
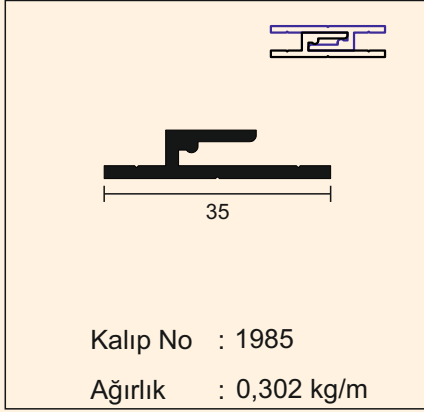

Katalogumuzda bulunan profil çizimleri örnek olarak konulmuştur. Müşterilerimize ait olan çizimlerin profilleri satılamaz. Çizimler üzerinden ölçü almayınız. Resimlerin altında yer alan profil ağırlığı bilgi amaçlı olup, ürünlerin teslim anındaki tartımız ağırlığı geçerlidir.

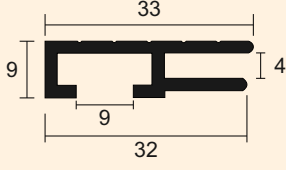

Kalıp No : 1584

Ağırlık : 0,366 kg/m

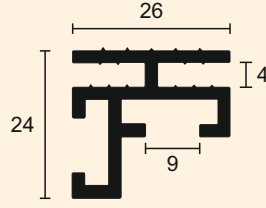

Kalıp No : 1770

Ağırlık : 0,550 kg/m

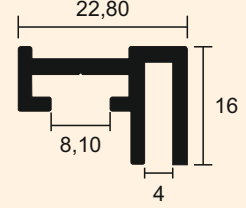

Kalıp No : 1861

Ağırlık : 0,335 kg/m

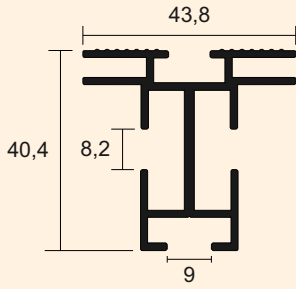

Kalıp No : 1583

Ağırlık : 0,848 kg/m

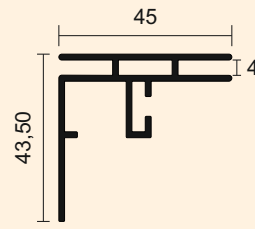

Kalıp No : 2100

Ağırlık : 0,703 kg/m

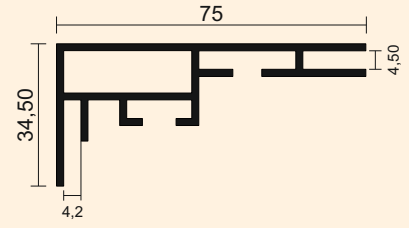

Kalıp No : 2411

Ağırlık : 1,050 kg/m

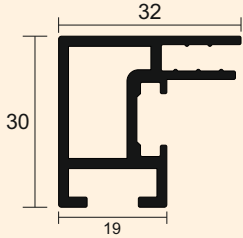

Kalıp No : 2417

Ağırlık : 0,632 kg/m

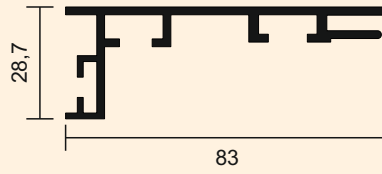

Kalıp No : 1927

Ağırlık : 1,010 kg/m

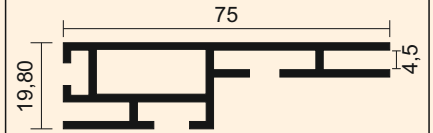

Kalıp No : 2173

Ağırlık : 0,997 kg/m

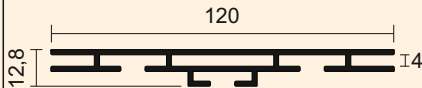

Kalıp No : 2114

Ağırlık : 1,336 kg/m

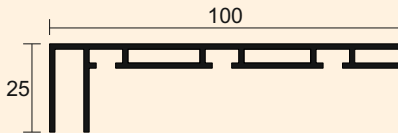

Kalıp No : 2124

Ağırlık : 1,020 kg/m

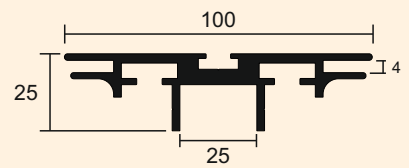

Kalıp No : 1978

Ağırlık : 1,805 kg/m

Kataloğumuzda bulunan profil çizimleri örnek olarak konulmuştur. Müşterilerimize ait olan çizimlerin profilleri satılamaz. Çizimler üzerinden ölçü almayınız. Resimlerin altında yer alan profil ağırlığı bilgi amaçlı olup, ürünlerin teslim anındaki tartımız ağırlığı geçerlidir.

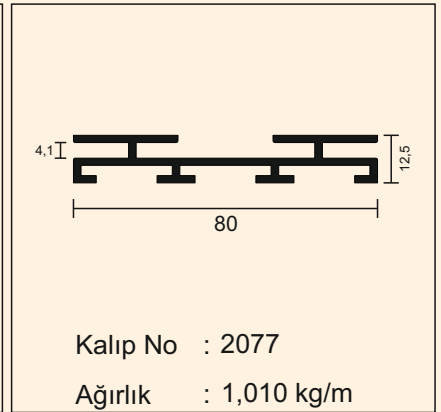
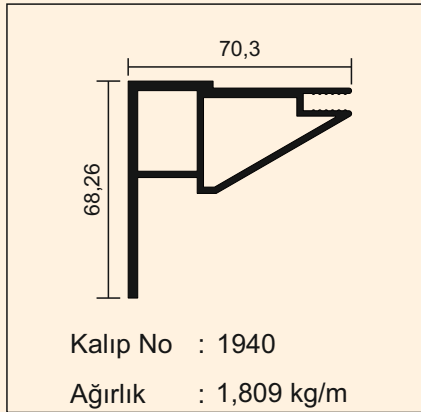
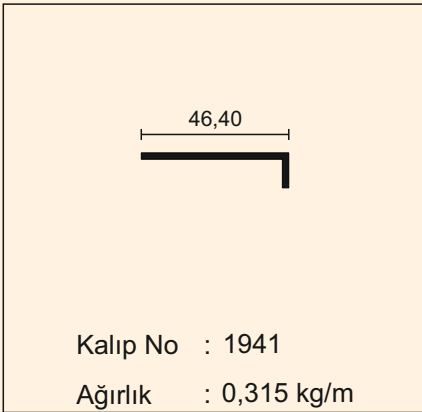
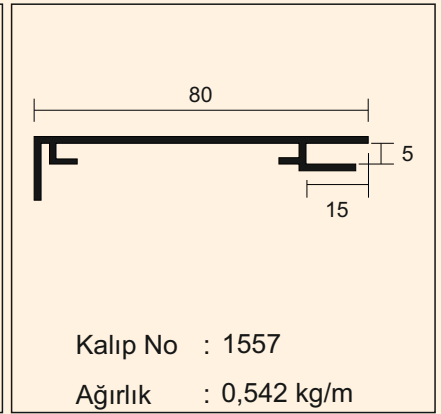
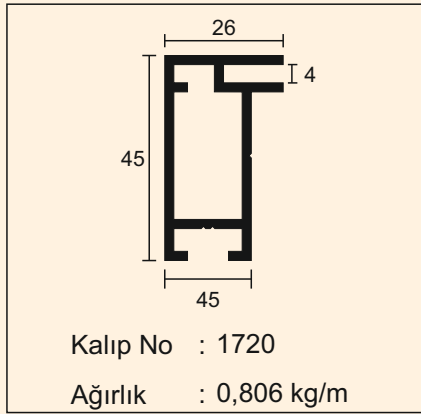
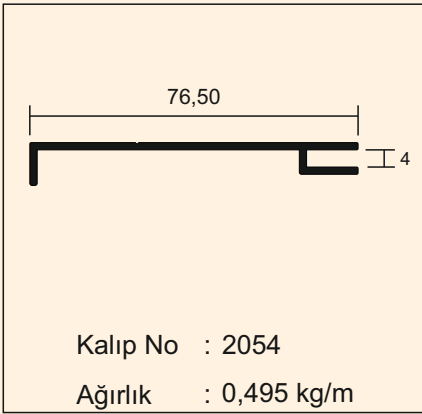
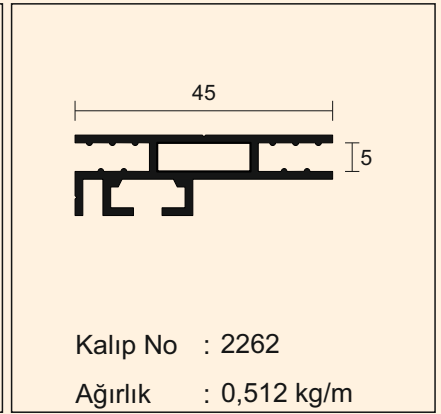
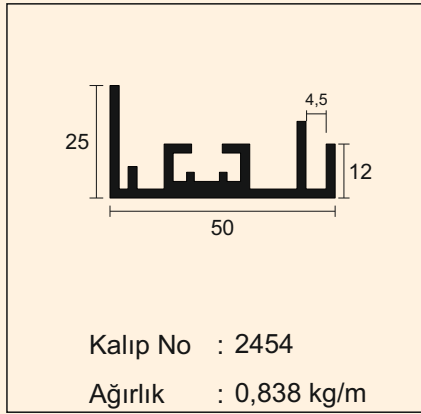
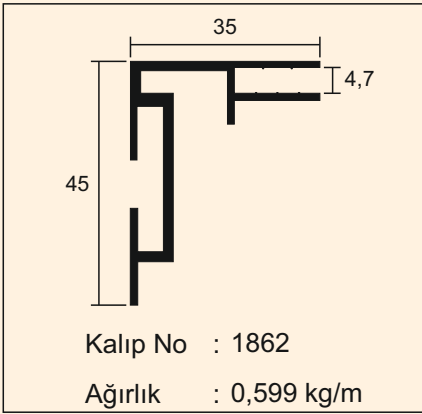
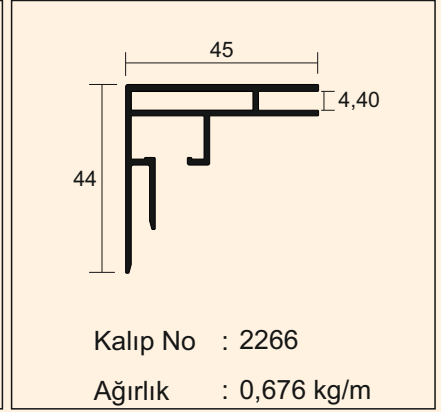
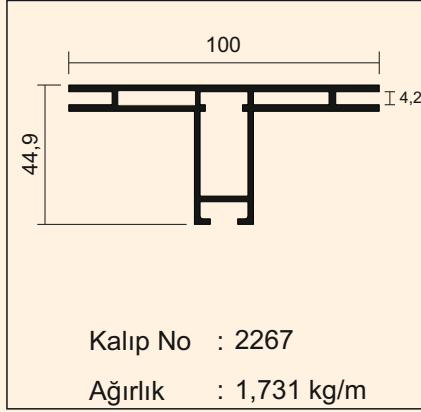
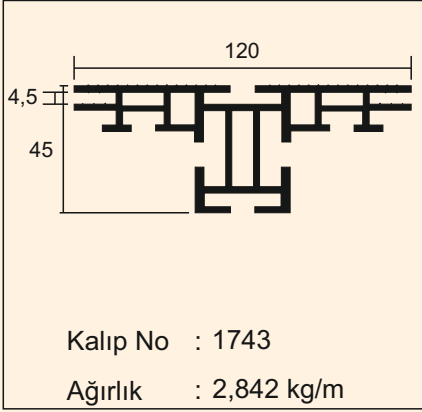

Katalogümüzda bulunan profil çizimleri örnek olarak konulmuştur. Müşterilerimize ait olan çizimlerin profilleri satılamaz. Çizimler üzerinden ölçü almayınız. Resimlerin altında yer alan profil ağırlığı bilgi amaçlı olup, ürünlerin teslim anındaki tartımız ağırlığı geçerlidir.

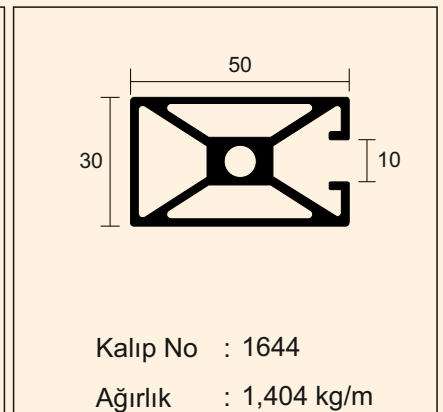
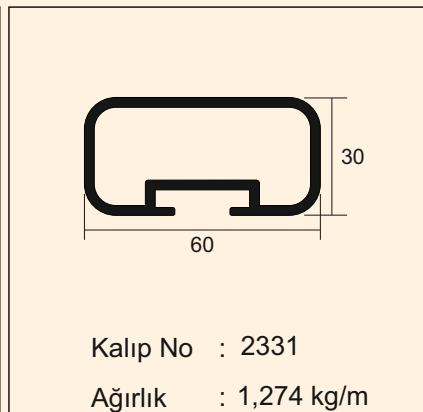
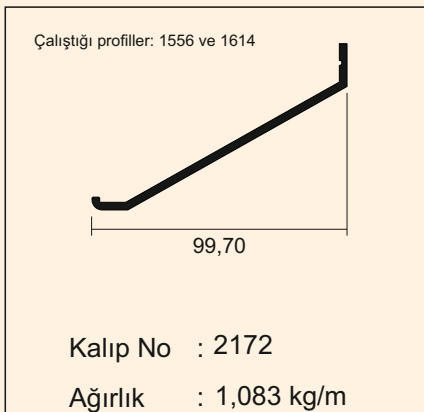
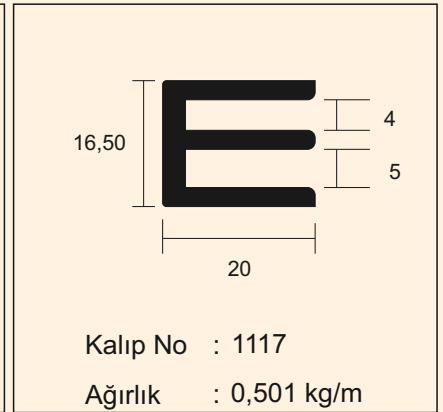
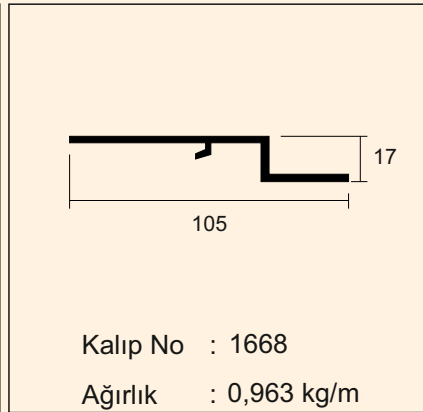
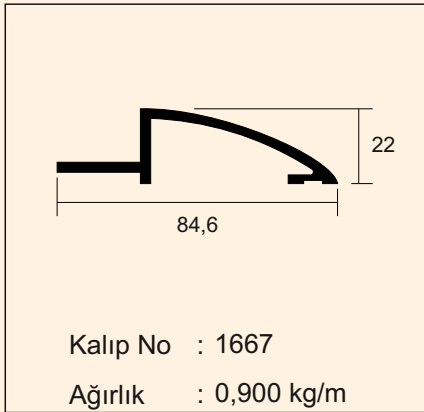
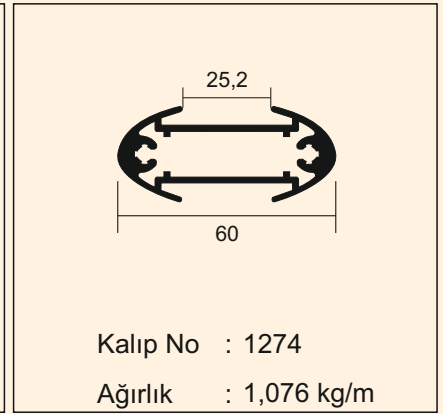
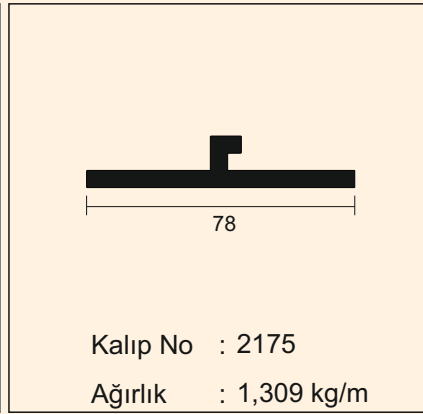
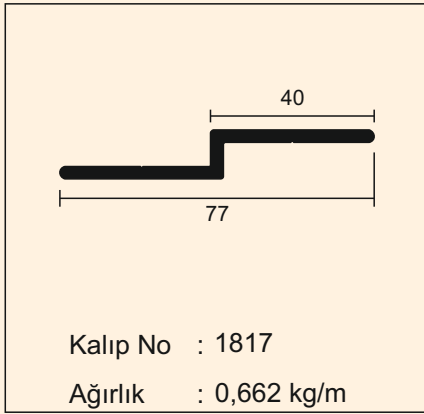
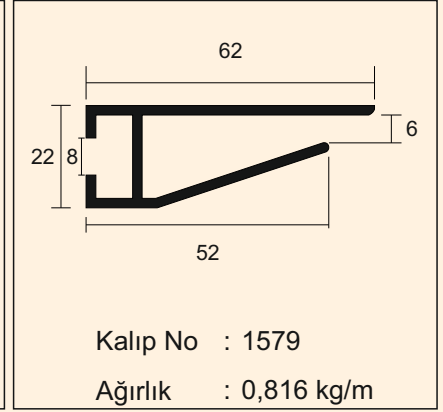
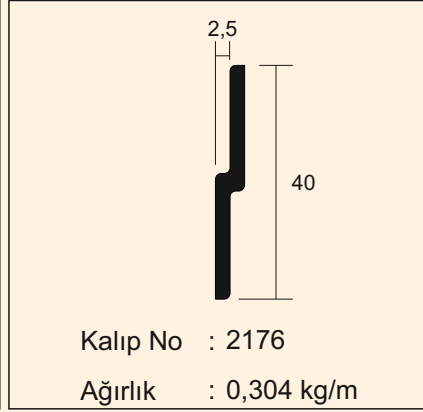
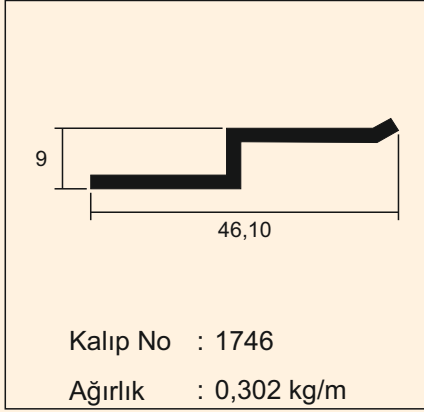

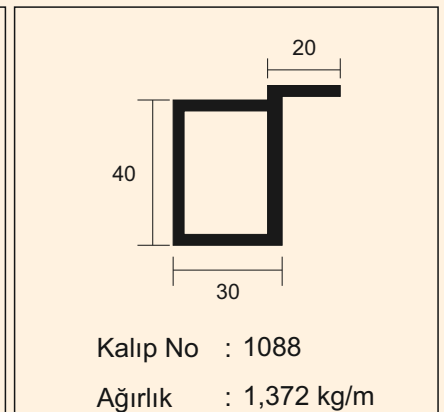
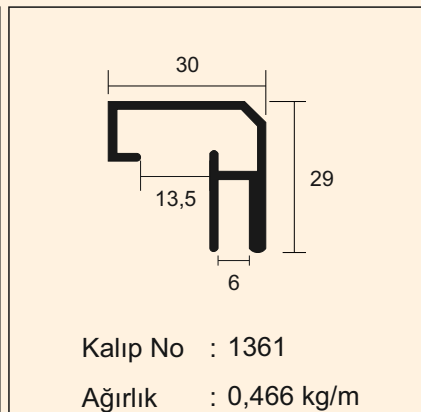
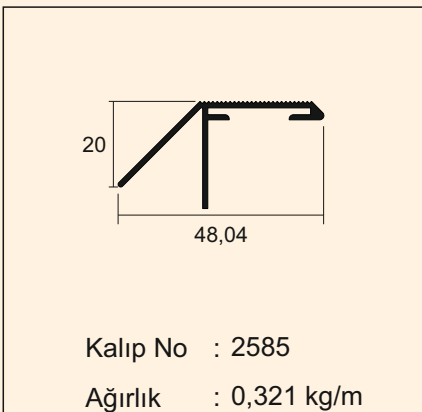
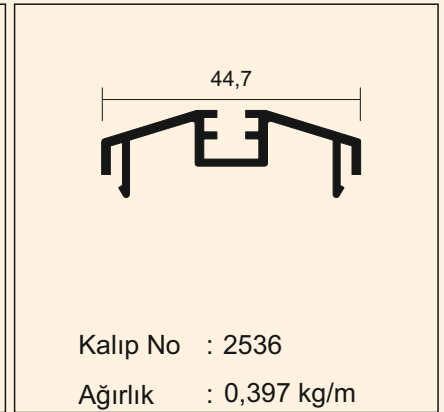
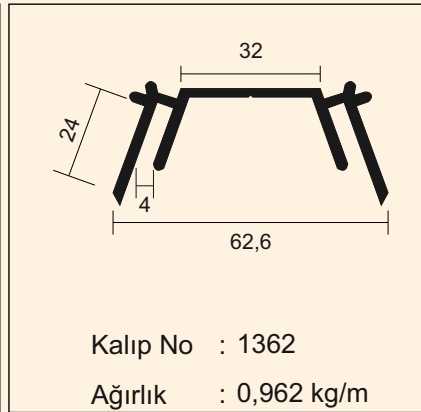
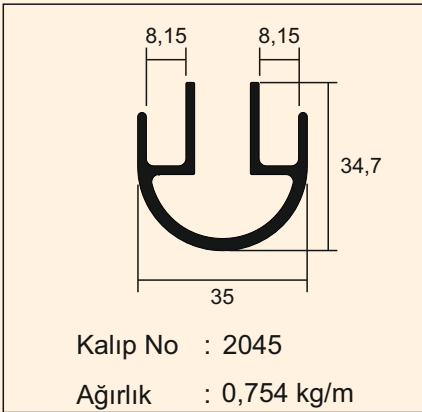
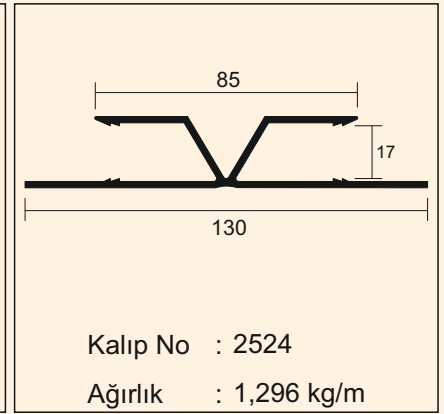
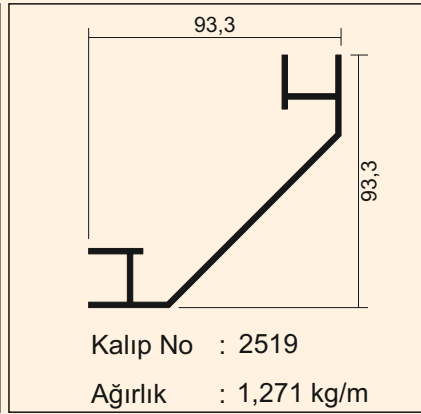
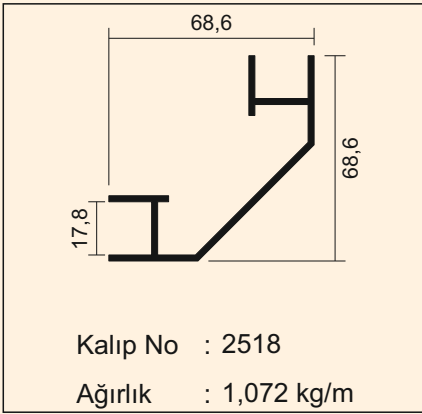
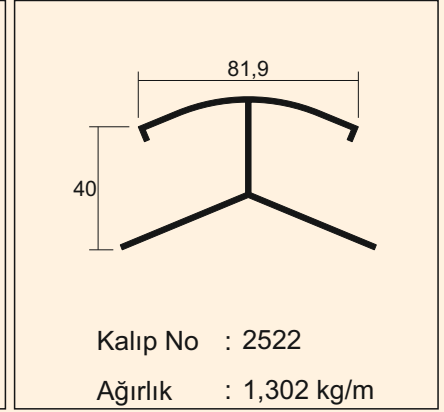
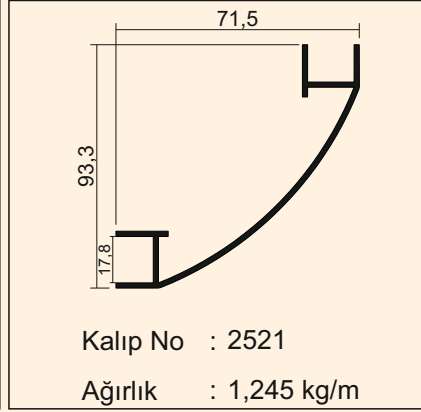
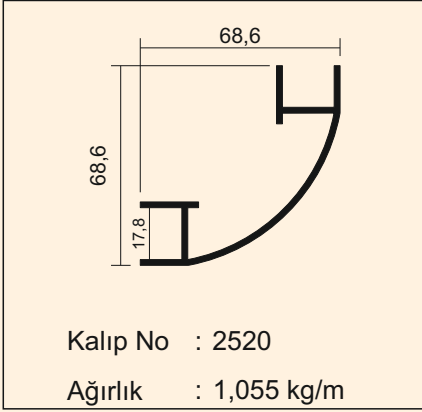

Katalogumuzda bulunan profil çizimleri örnek olarak konulmuştur. Müşterilerimize ait olan çizimlerin profilleri satılamaz. Çizimler üzerinden ölçü almayınız. Resimlerin altında yer alan profil ağırlığı bilgi amaçlı olup, ürünlerin teslim anındaki tartımız ağırlığı geçerlidir.

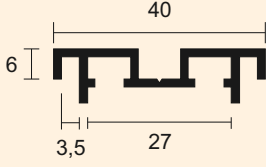

Kalıp No : 1357

Ağırlık : 0,349 kg/m

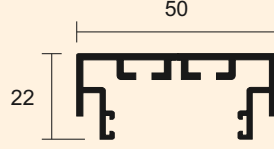

Kalıp No : 1459

Ağırlık : 0,656 kg/m

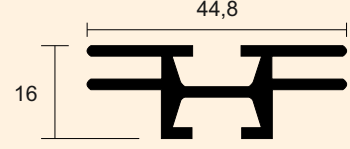

Kalıp No : 1615

Ağırlık : 0,626 kg/m

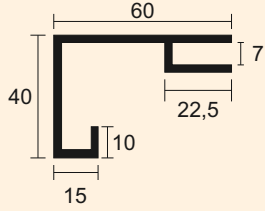

Kalıp No : 1360

Ağırlık : 1,046 kg/m

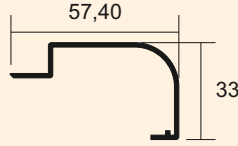

Kalıp No : 1133

Ağırlık : 0,435 kg/m

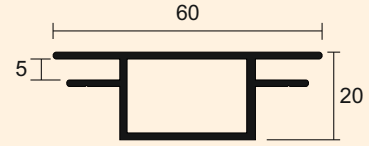

Kalıp No : 1553

Ağırlık : 0,628 kg/m

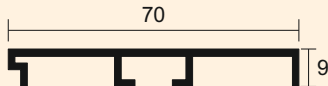

Kalıp No : 2497

Ağırlık : 0,533 kg/m

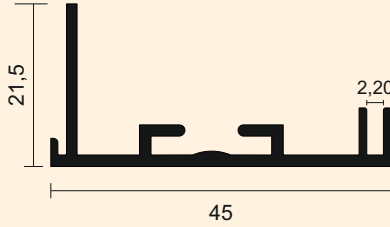

Kalıp No : 2187

Ağırlık : 0,388 kg/m

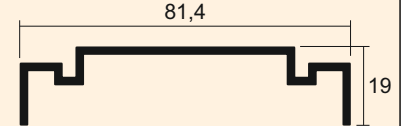

Kalıp No : 2442

Ağırlık : 0,556 kg/m

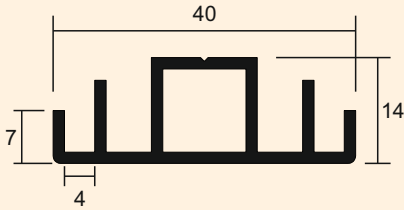

Kalıp No : 1447

Ağırlık : 0,450 kg/m

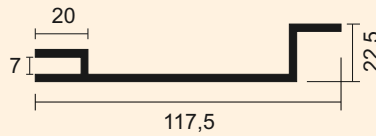

Kalıp No : 1366

Ağırlık : 1,170 kg/m

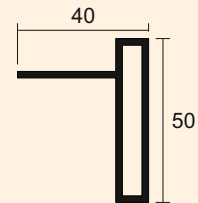

Kalıp No : 1995

Ağırlık : 0,808 kg/m

Katalogumuzda bulunan profil çizimleri örnek olarak konulmuştur. Müşterilerimize ait olan çizimlerin profilleri satılamaz. Çizimler üzerinden ölçü almayınız. Resimlerin altında yer alan profil ağırlığı bilgi amaçlı olup, ürünlerin teslim anındaki tartımız ağırlığı geçerlidir.

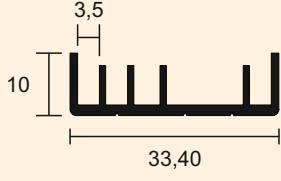

Kalıp No : 1843
Ağırlık : 0,287 kg/m

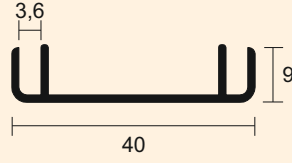

Kalıp No : 2526
Ağırlık : 0,239 kg/m

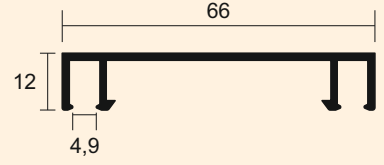

Kalıp No : 2525
Ağırlık : 0,468 kg/m

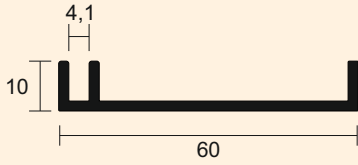

Kalıp No : 2235
Ağırlık : 0,477 kg/m

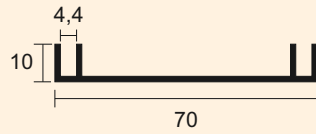

Kalıp No : 1444
Ağırlık : 0,388 kg/m

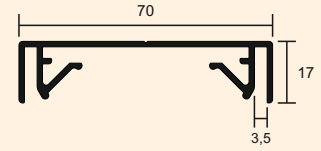

Kalıp No : 2069
Ağırlık : 0,694 kg/m

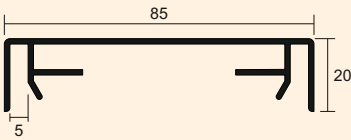

Kalıp No : 2486
Ağırlık : 0,766 kg/m

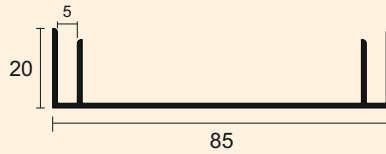

Kalıp No : 2604
Ağırlık : 0,525 kg/m

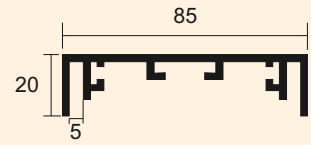

Kalıp No : 1448
Ağırlık : 1,046 kg/m

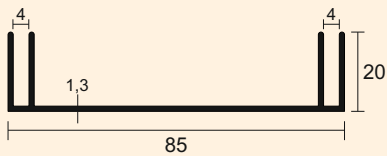

Kalıp No : 2401
Ağırlık : 0,589 kg/m

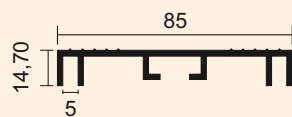

Kalıp No : 1290
Ağırlık : 0,834 kg/m



Kalıp No : 2324
Ağırlık : 0,888 kg/m

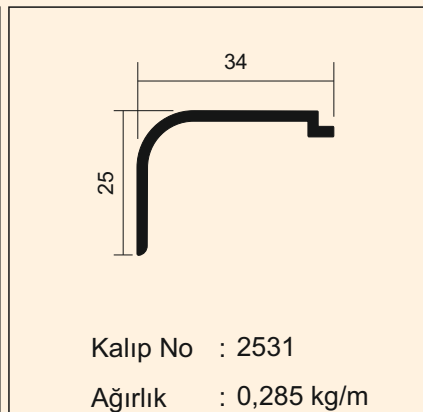
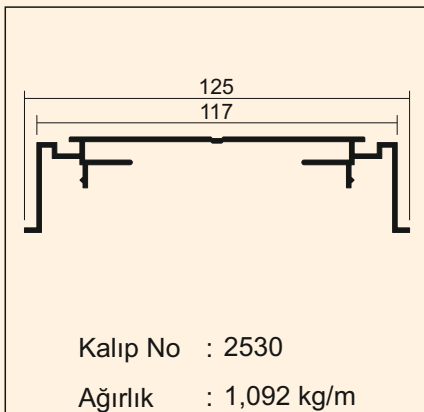
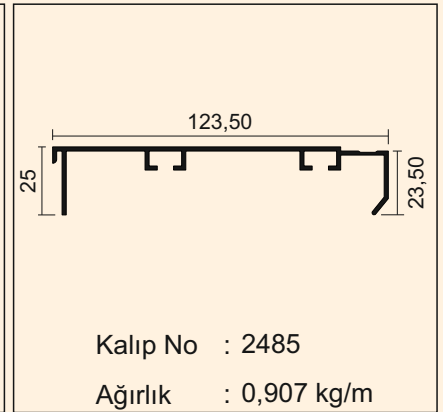
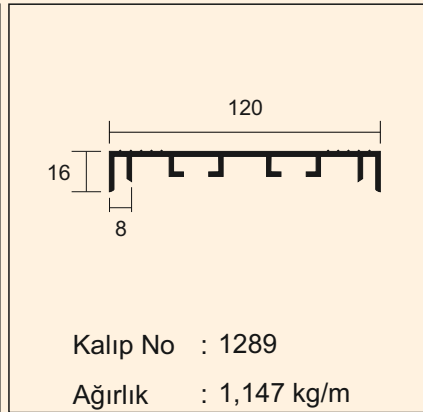
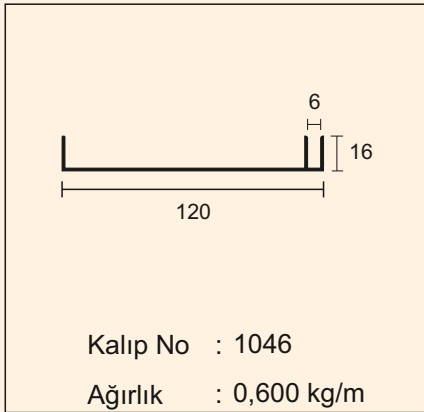
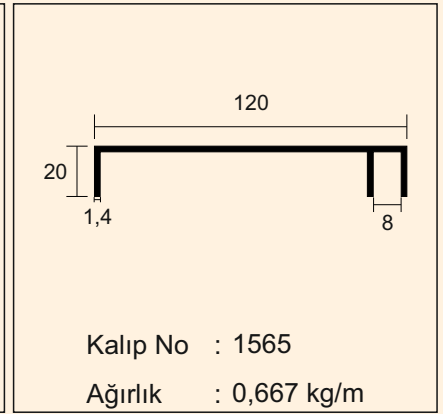
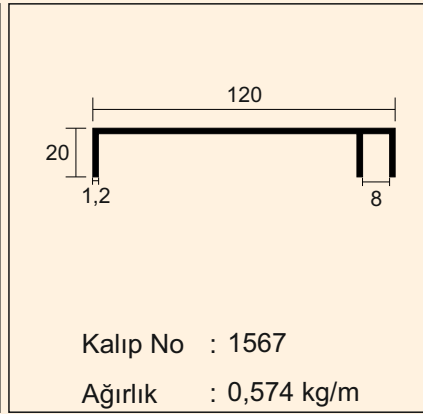
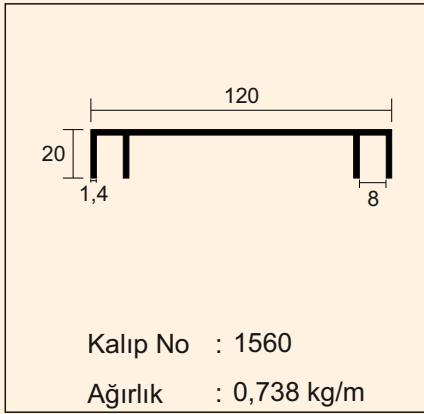
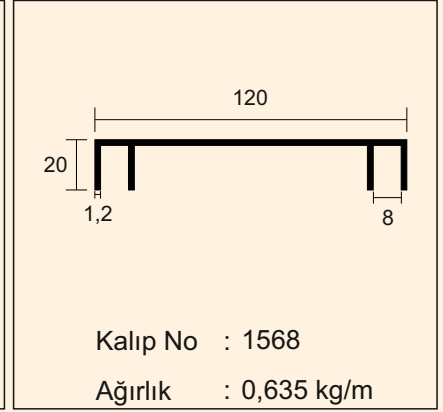
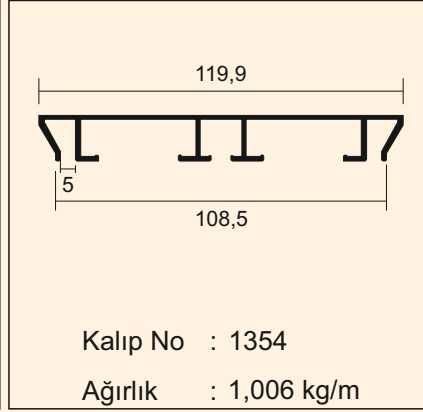
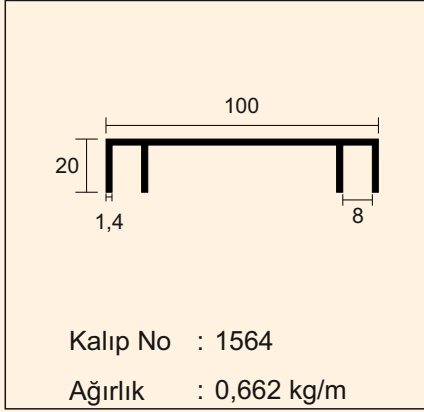

Katalogumuzda bulunan profil çizimleri örnek olarak konulmuştur. Müşterilerimize ait olan çizimlerin profilleri satılamaz. Çizimler üzerinden ölçü almayınız. Resimlerin altında yer alan profil ağırlığı bilgi amaçlı olup, ürünlerin teslim anındaki tartımız ağırlığı geçerlidir.

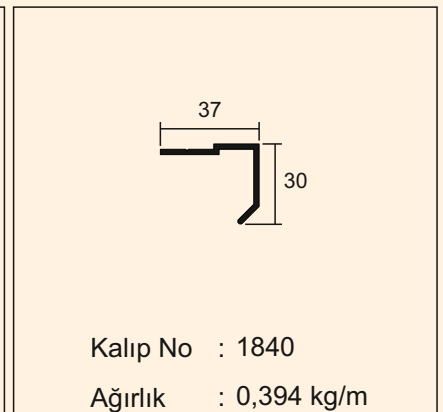
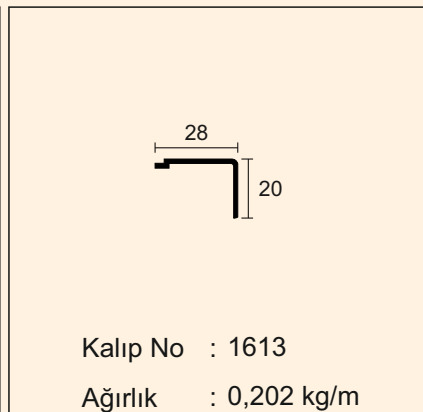
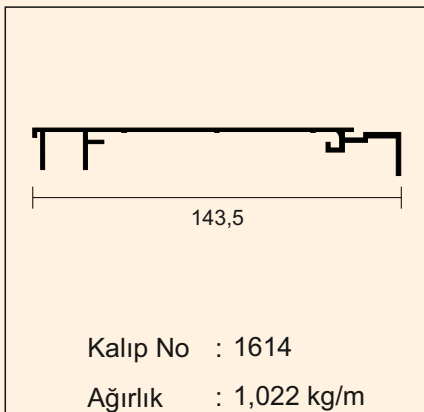
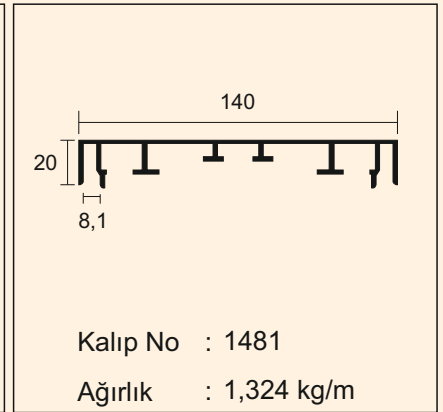
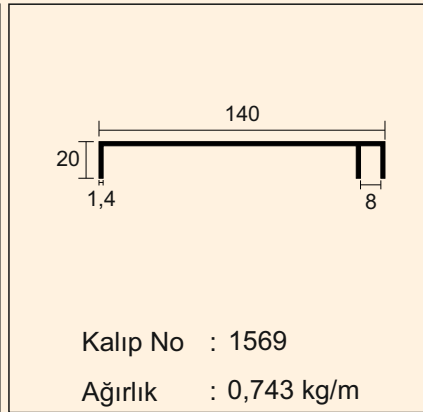
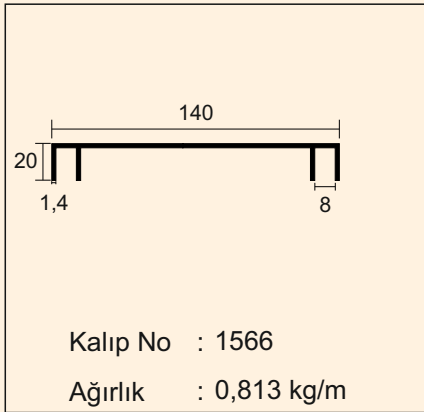
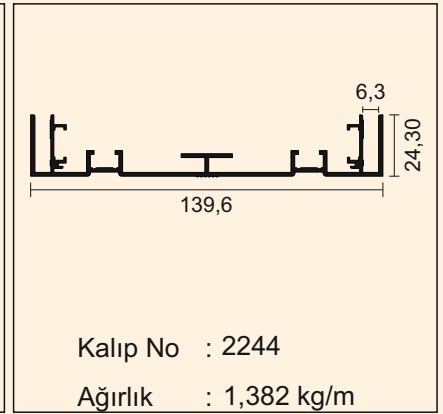
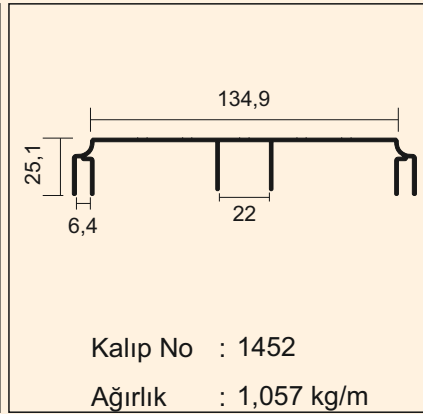
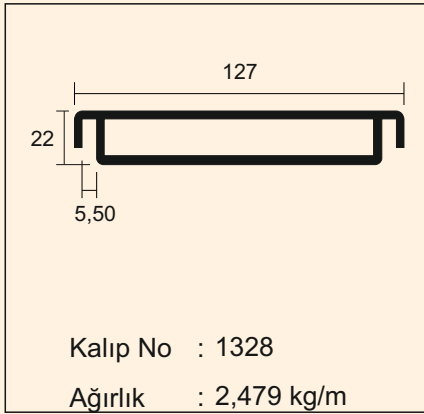
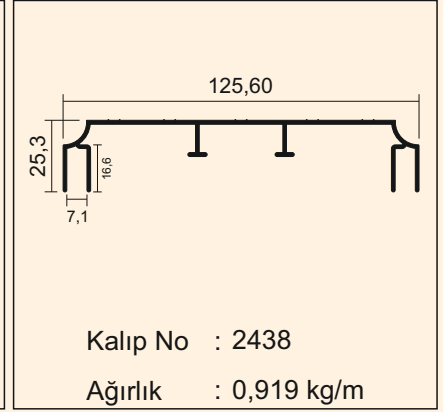
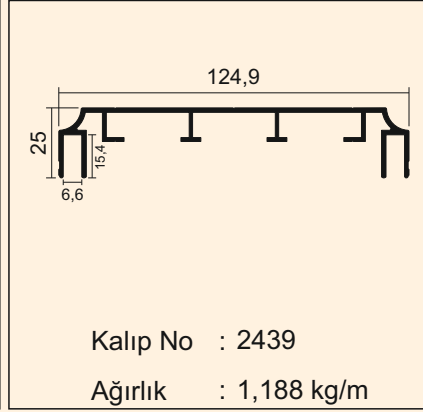
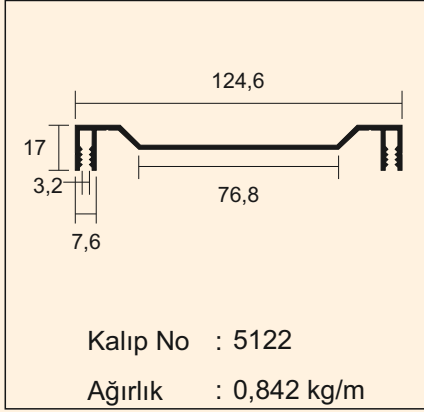

Kataloğumuzda bulunan profil çizimleri örnek olarak konulmuştur. Müşterilerimize ait olan çizimlerin profilleri satılamaz. Çizimler üzerinden ölçü almayınız. Resimlerin altında yer alan profil ağırlığı bilgi amaçlı olup, ürünlerin teslim anındaki tartımız ağırlığı geçerlidir.

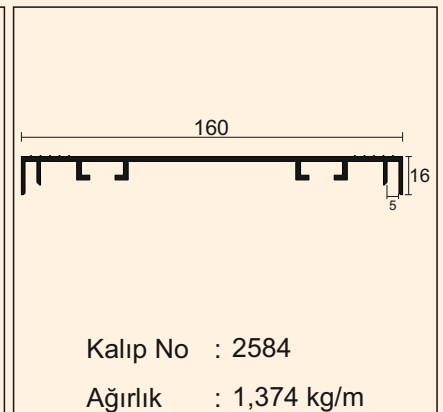
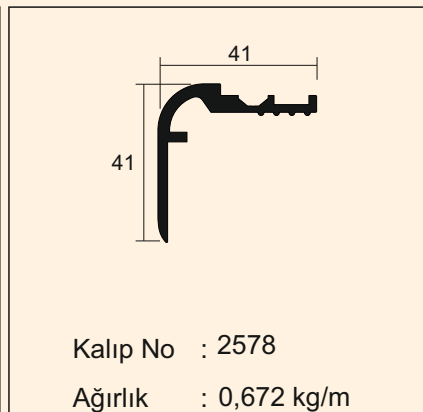
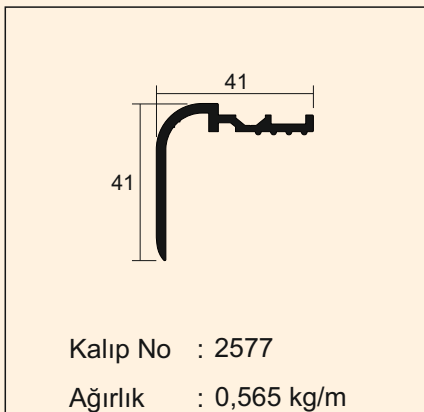
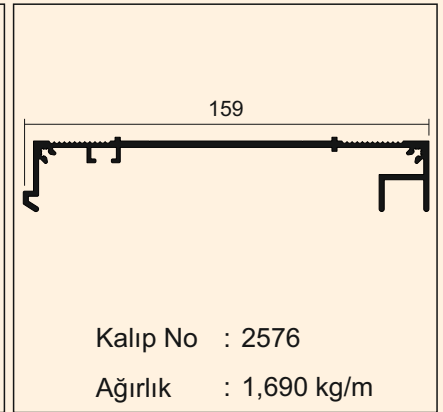
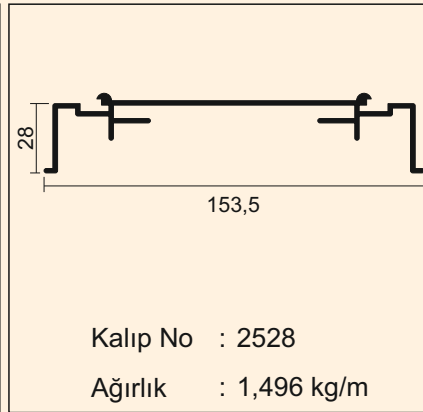
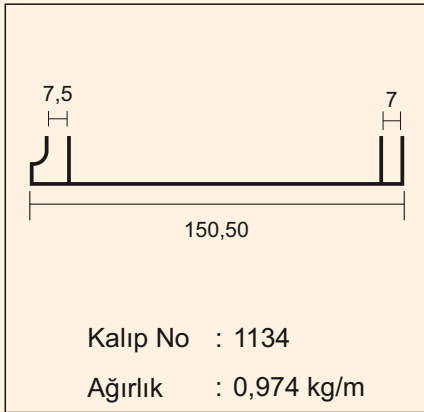
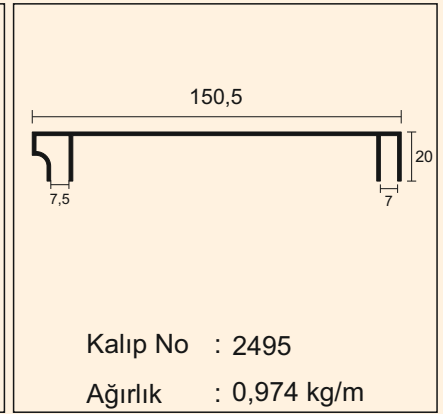
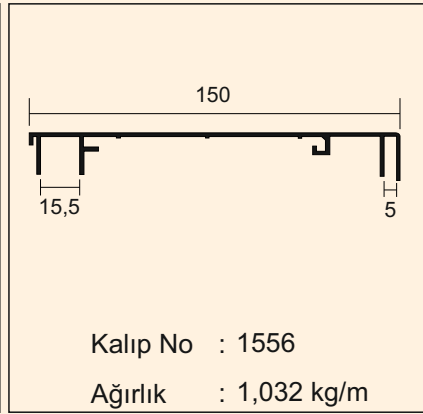
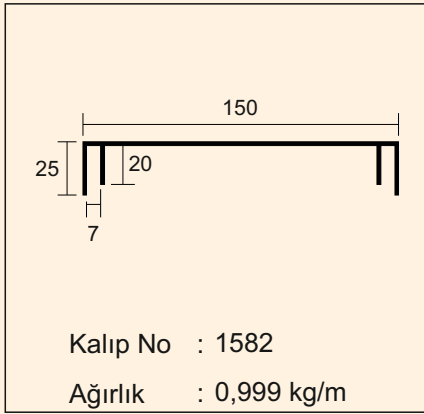
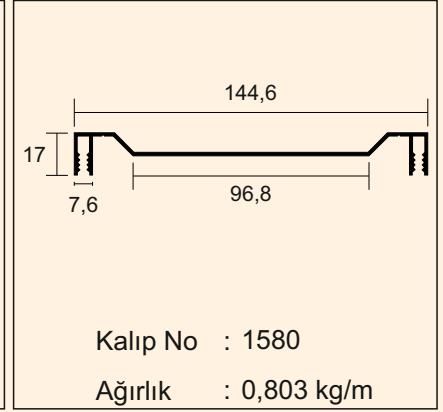
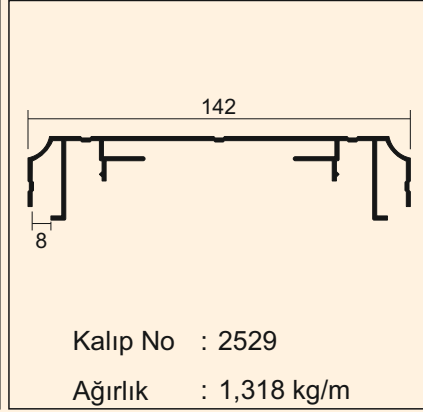
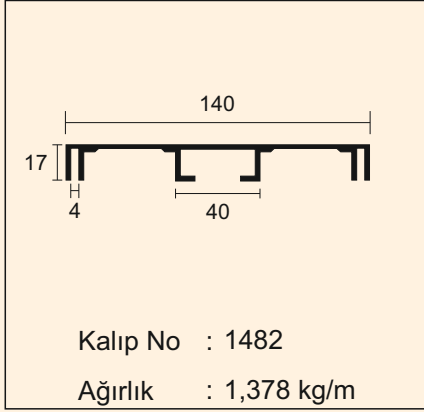

Katalogumuzda bulunan profil çizimleri örnek olarak konulmuştur. Müşterilerimize ait olan çizimlerin profilleri satılamaz. Çizimler üzerinden ölçü almayınız. Resimlerin altında yer alan profil ağırlığı bilgi amaçlı olup, ürünlerin teslim anındaki tartımız ağırlığı geçerlidir.

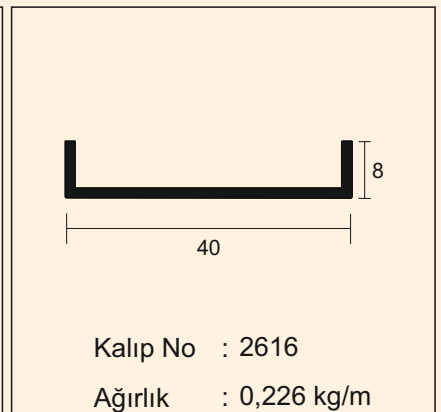
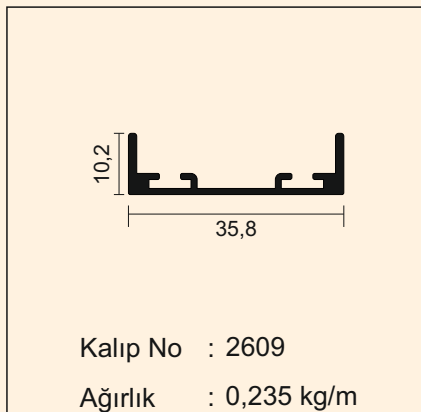
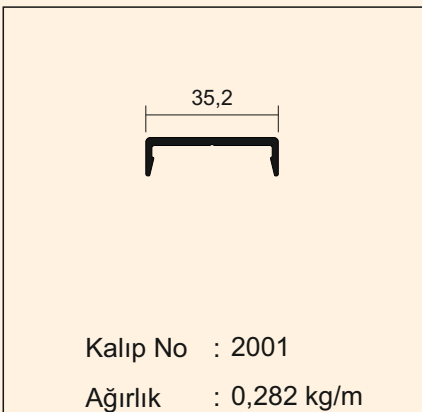
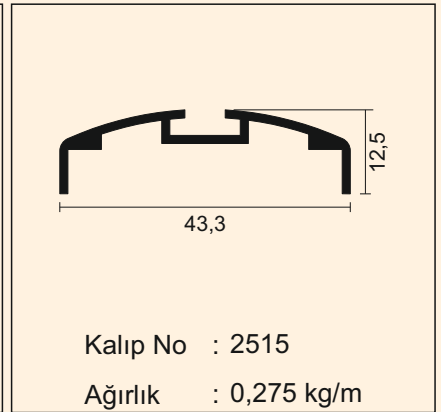
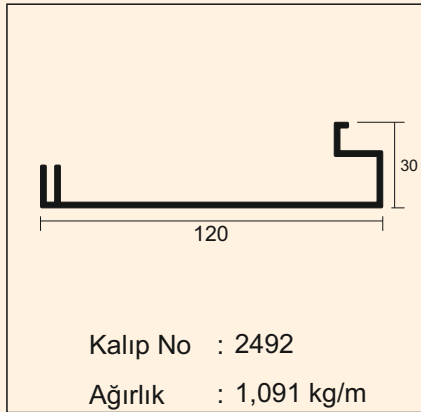
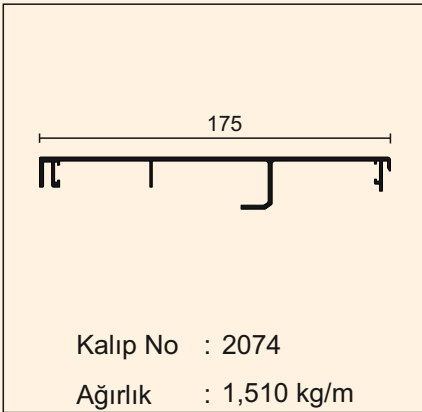
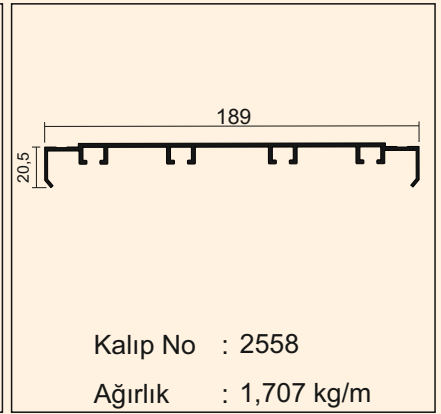
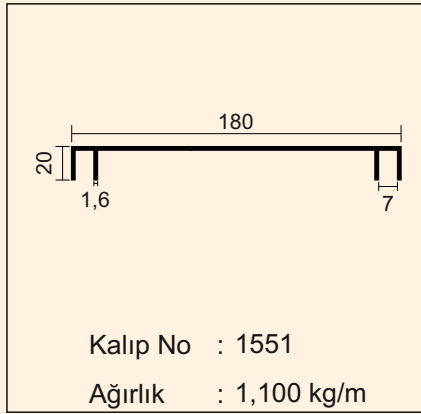
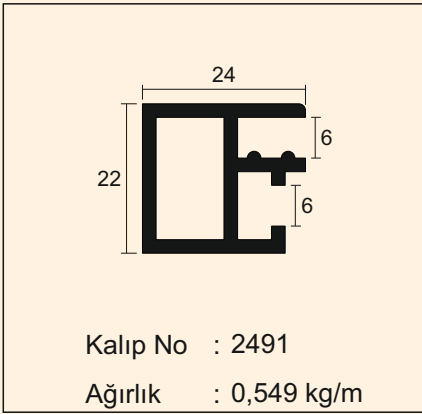
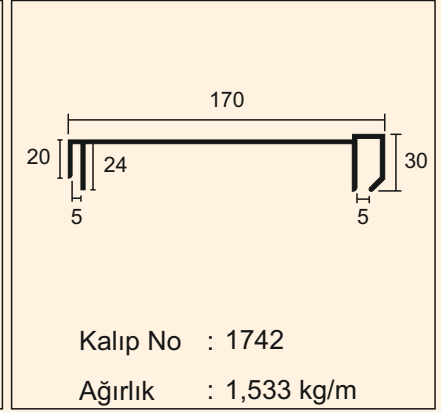
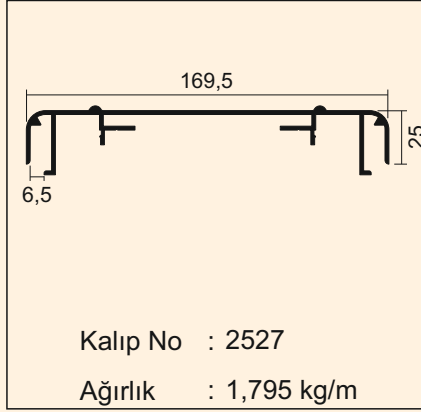
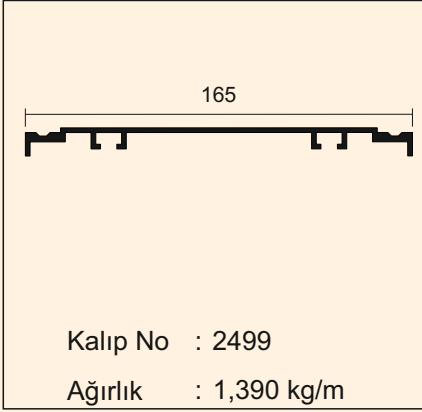

Katalogumuzda bulunan profil çizimleri örnek olarak konulmuştur. Müşterilerimize ait olan çizimlerin profilleri satılamaz. Çizimler üzerinden ölçü almayınız. Resimlerin altında yer alan profil ağırlığı bilgi amaçlı olup, ürünlerin teslim anındaki tartımız ağırlığı geçerlidir.

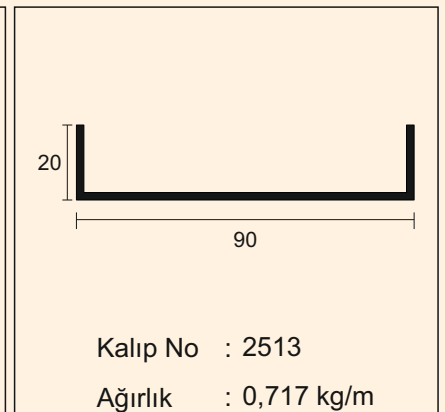
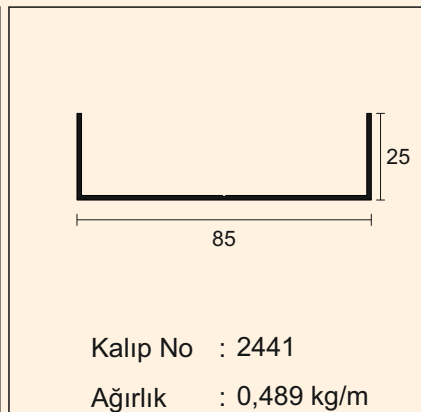
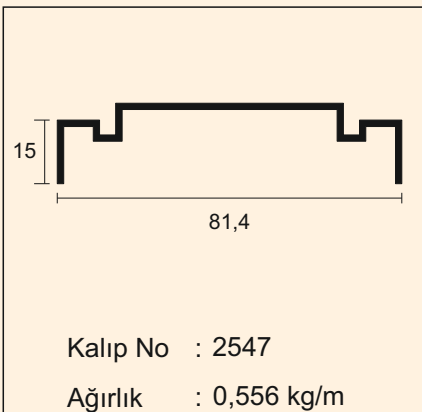
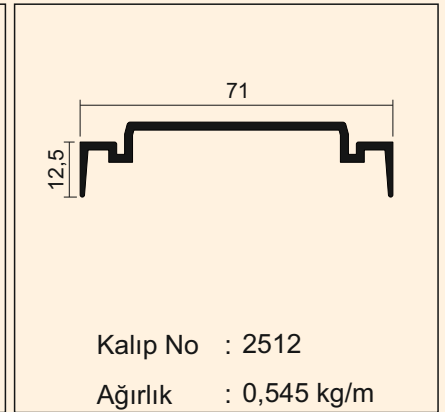
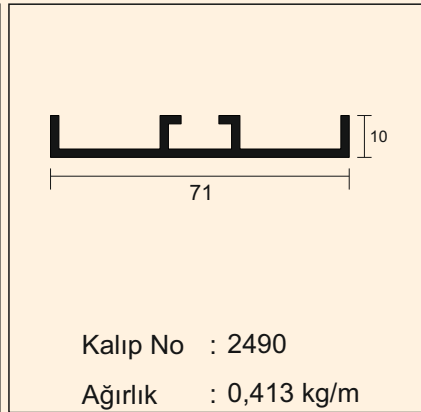
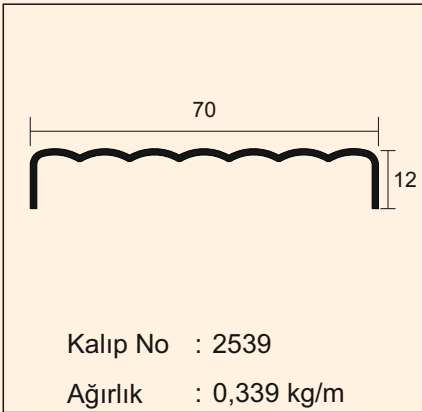
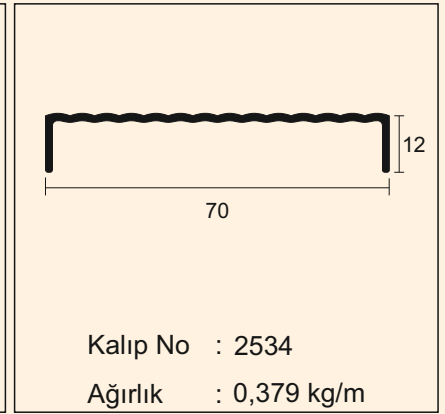
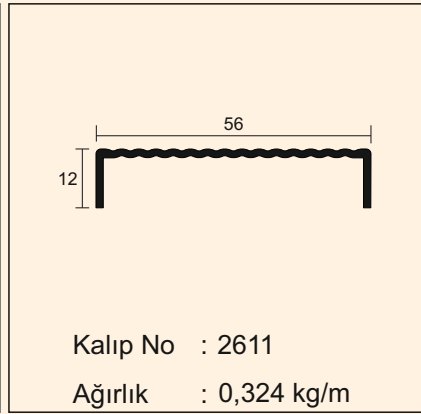
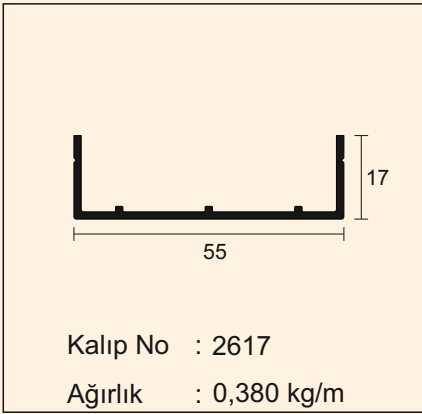
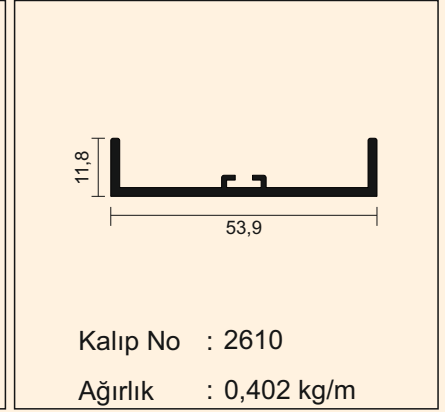
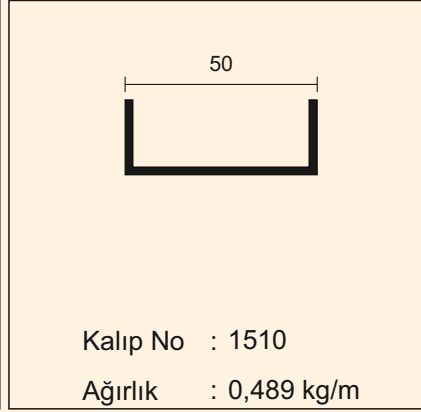
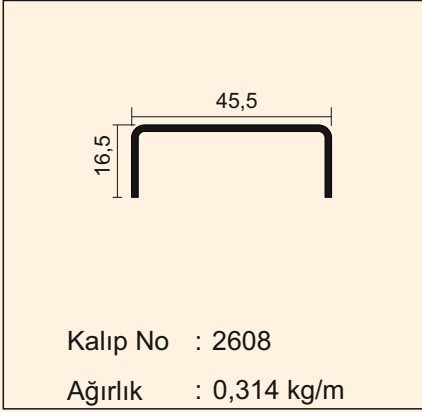

Katalogumuzda bulunan profil çizimleri örnek olarak konulmuştur. Müşterilerimize ait olan çizimlerin profilleri satılamaz. Çizimler üzerinden ölçü almayınız. Resimlerin altında yer alan profil ağırlığı bilgi amaçlı olup, ürünlerin teslim anındaki tartımız ağırlığı geçerlidir.

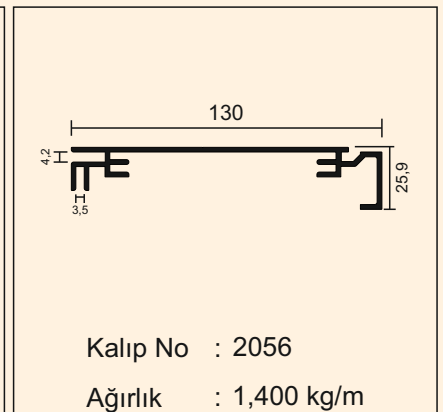
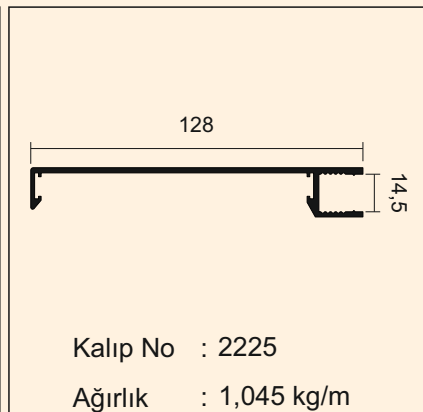
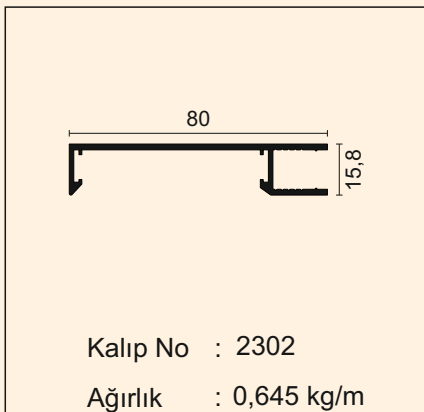
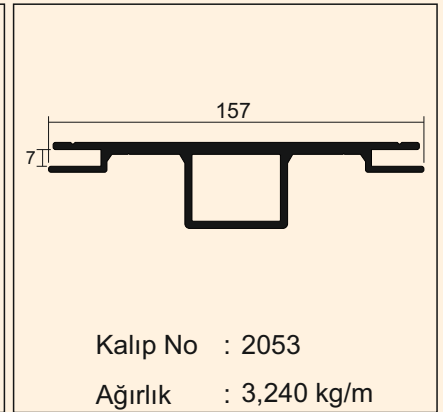
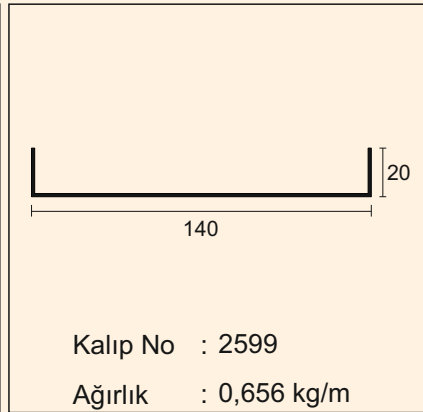
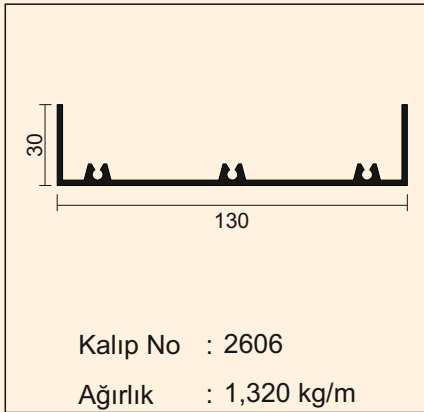
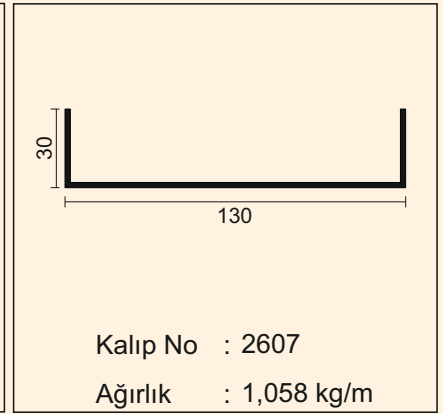
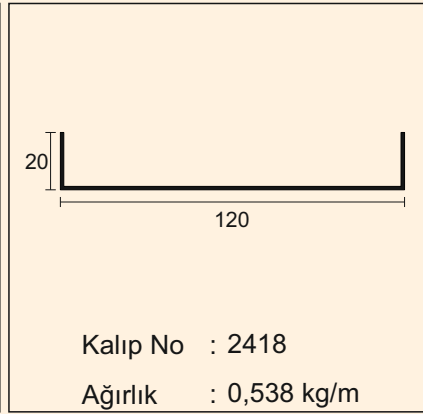
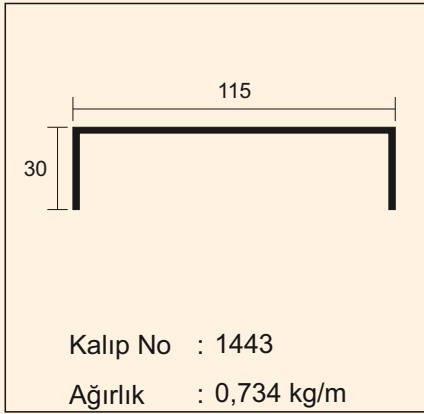
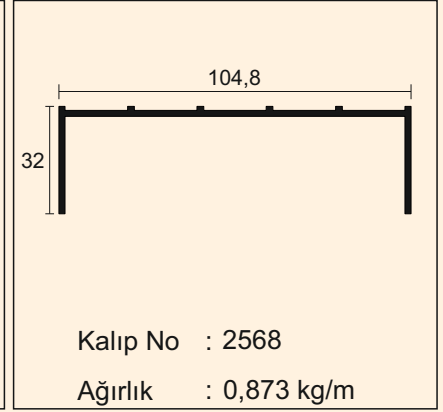
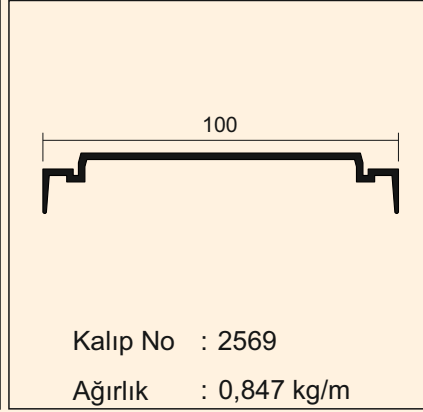
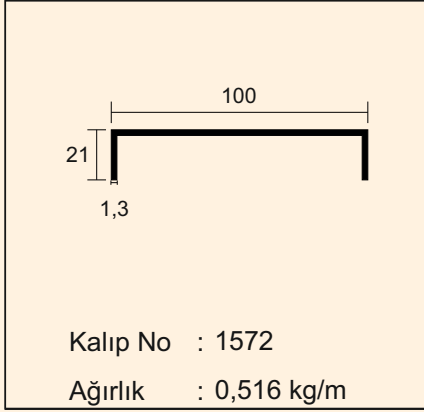

Katalogumuzda bulunan profil çizimleri örnek olarak konulmuştur. Müşterilerimize ait olan çizimlerin profilleri satılamaz. Çizimler üzerinden ölçü almayınız. Resimlerin altında yer alan profil ağırlığı bilgi amaçlı olup, ürünlerin teslim anındaki tartımız ağırlığı geçerlidir.

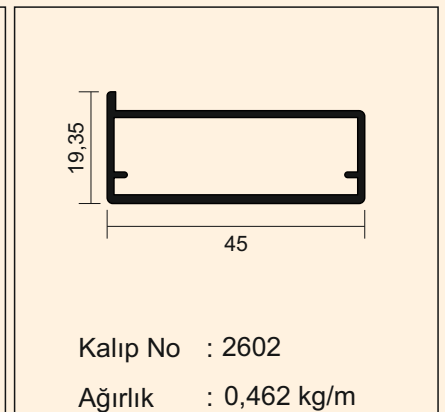
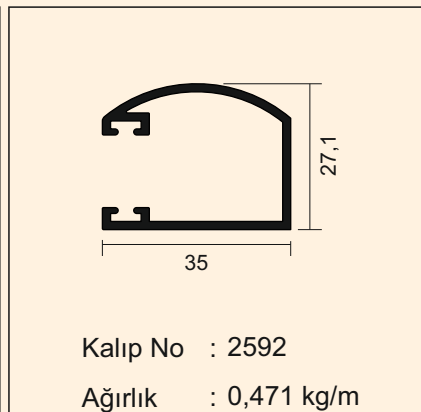
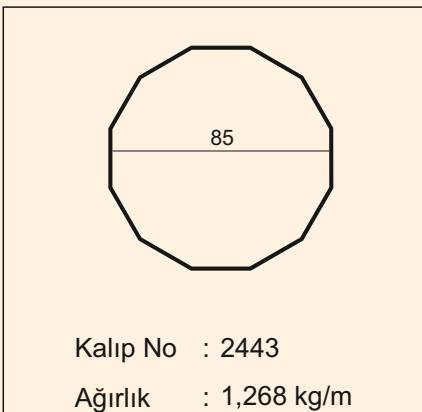
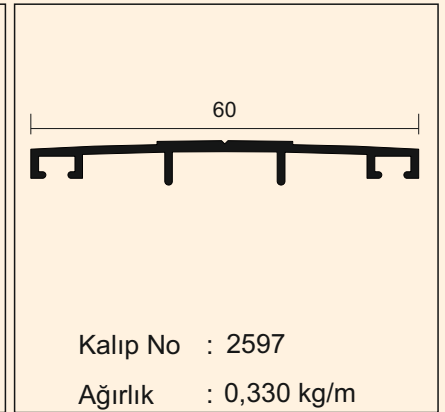
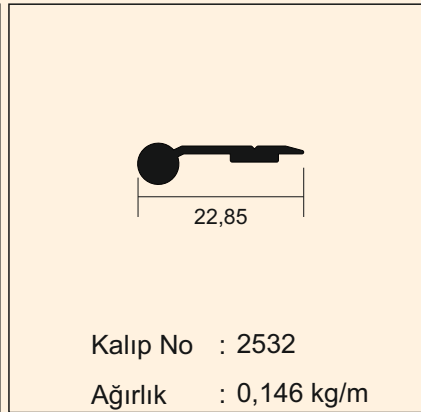
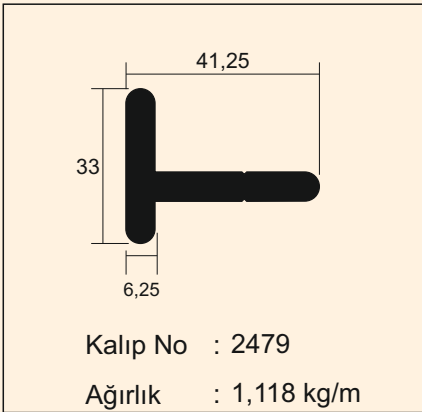
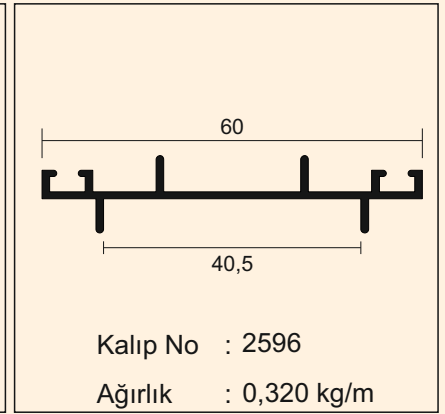
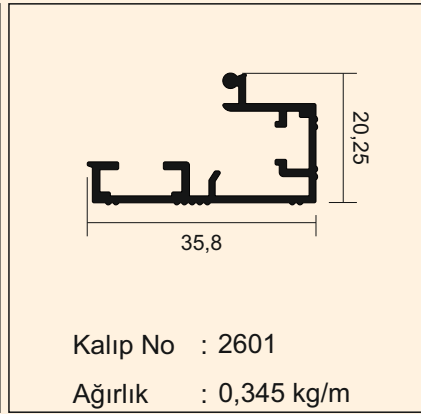
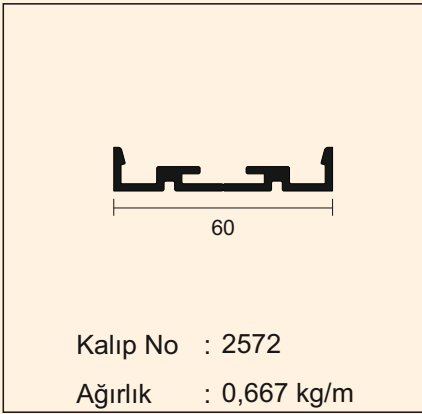
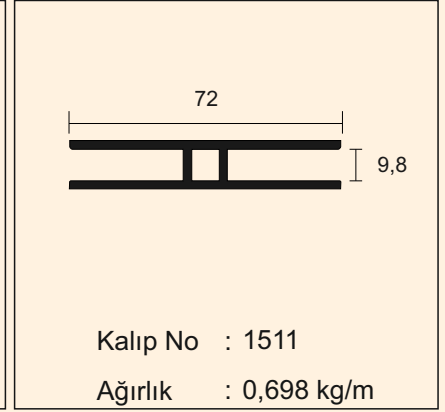
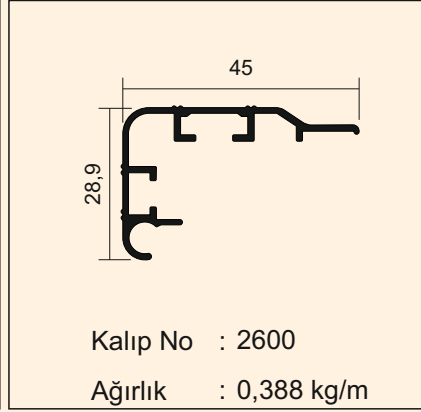
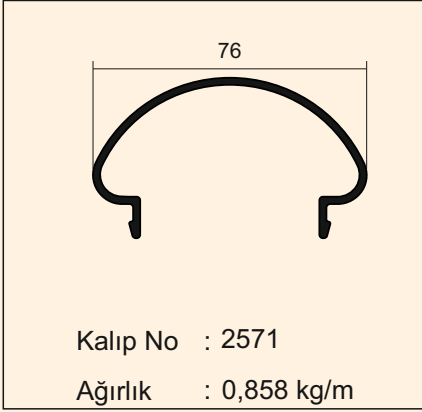

Kataloğumuzda bulunan profil çizimleri örnek olarak konulmuştur. Müşterilerimize ait olan çizimlerin profilleri satılamaz. Çizimler üzerinden ölçü almayınız. Resimlerin altında yer alan profil ağırlığı bilgi amaçlı olup, ürünlerin teslim anındaki tartımız ağırlığı geçerlidir.

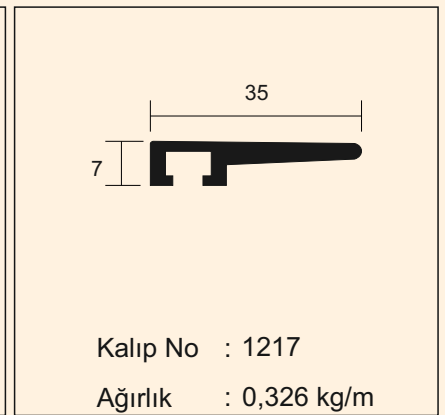
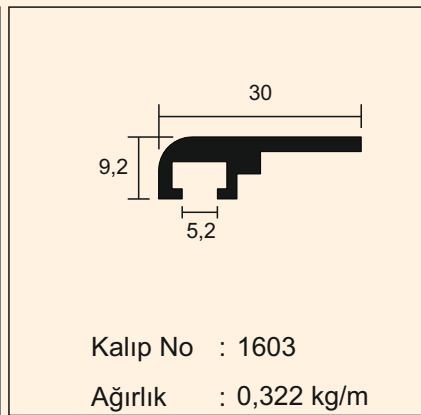
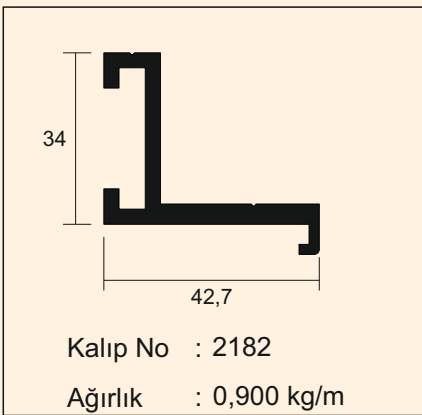
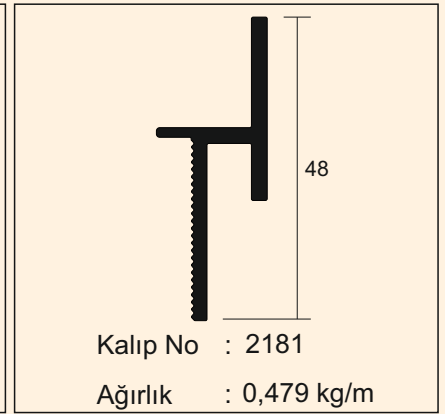
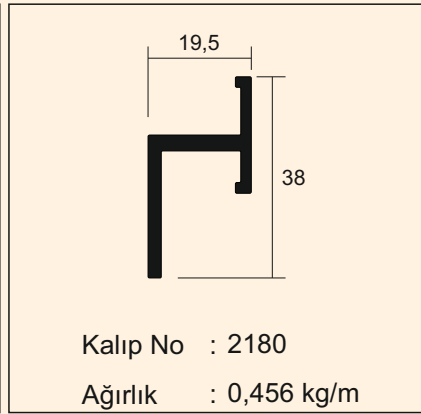
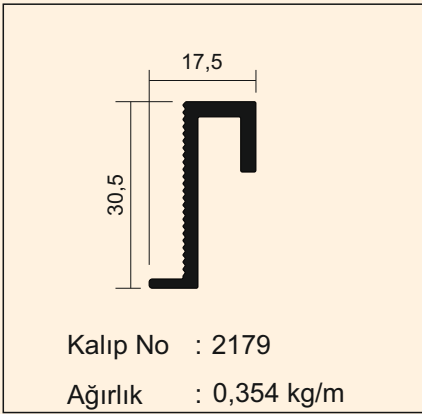
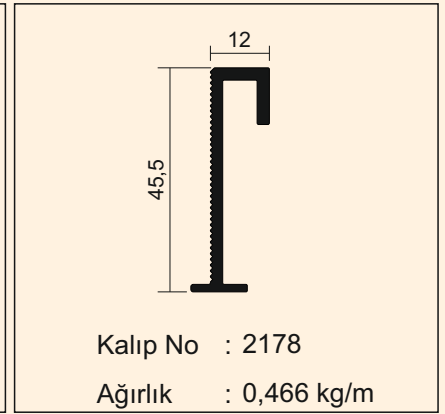
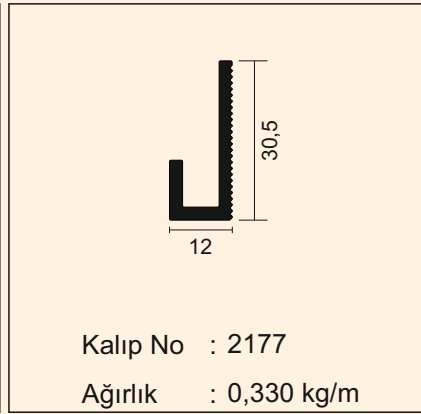
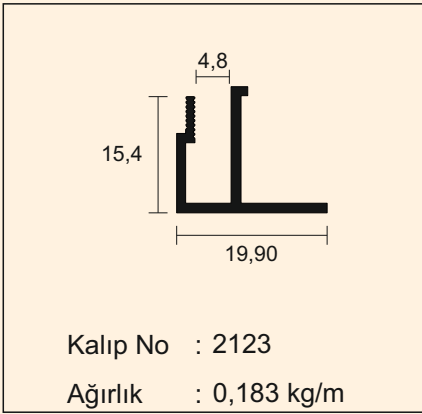
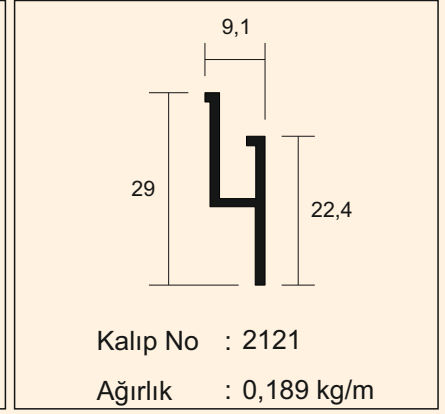
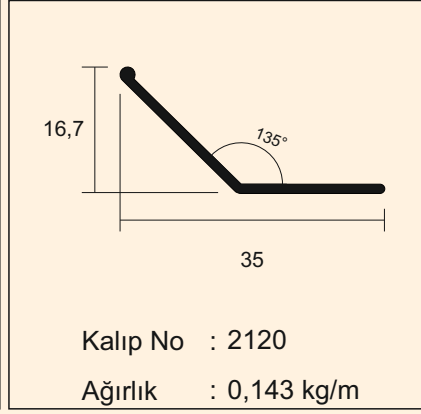
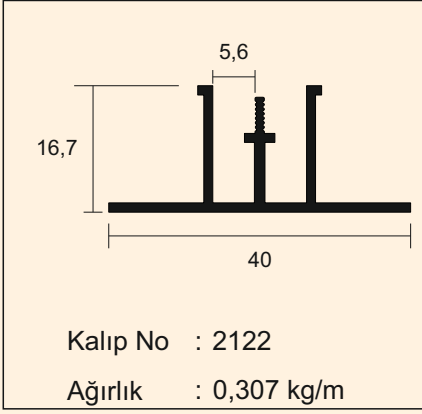

Katalogümüzda bulunan profil çizimleri örnek olarak konulmuştur. Müşterilerimize ait olan çizimlerin profilleri satılamaz. Çizimler üzerinden ölçü almayınız. Resimlerin altında yer alan profil ağırlığı bilgi amaçlı olup, ürünlerin teslim anındaki tartımız ağırlığı geçerlidir.

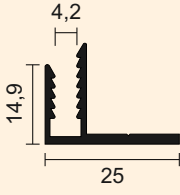

Kalıp No : 1515
Ağırlık : 0,240 kg/m

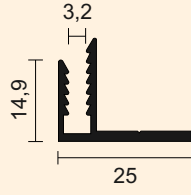

Kalıp No : 1516
Ağırlık : 0,234 kg/m

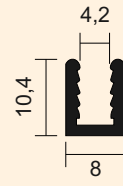

Kalıp No : 1508
Ağırlık : 0,117 kg/m

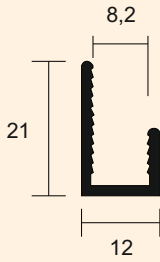

Kalıp No : 1558
Ağırlık : 0,187 kg/m

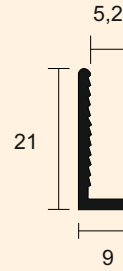

Kalıp No : 1559
Ağırlık : 0,174 kg/m

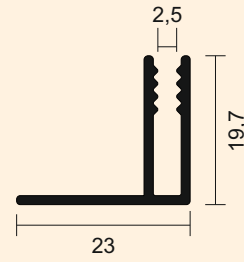

Kalıp No : 2322
Ağırlık : 0,215 kg/m

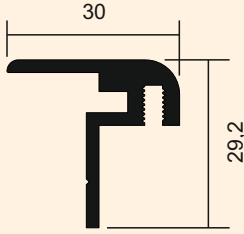

Kalıp No : 1646
Ağırlık : 0,534 kg/m

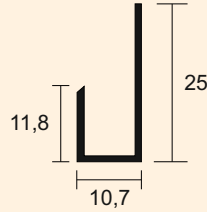

Kalıp No : 1369
Ağırlık : 0,127 kg/m

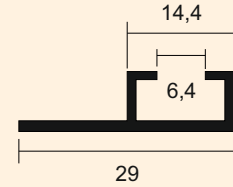

Kalıp No : 1555
Ağırlık : 0,165 kg/m

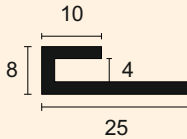

Kalıp No : 1616
Ağırlık : 0,222 kg/m

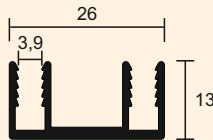

Kalıp No : 2057
Ağırlık : 0,286 kg/m

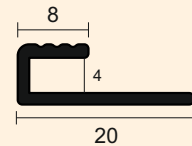

Kalıp No : 2556
Ağırlık : 0,119 kg/m

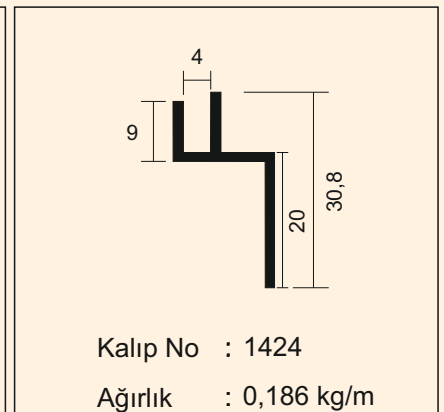
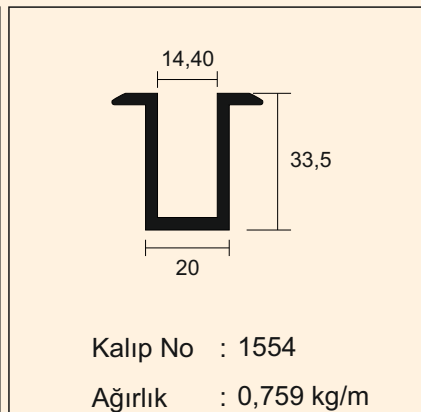
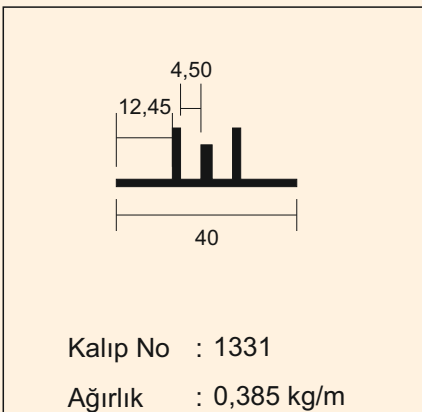
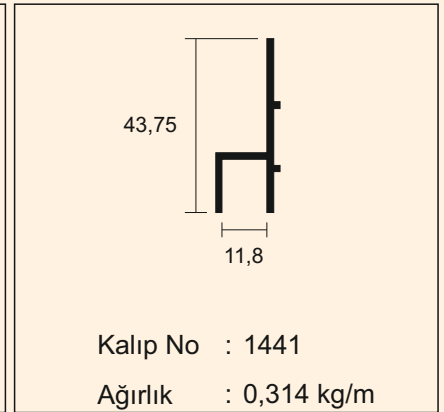
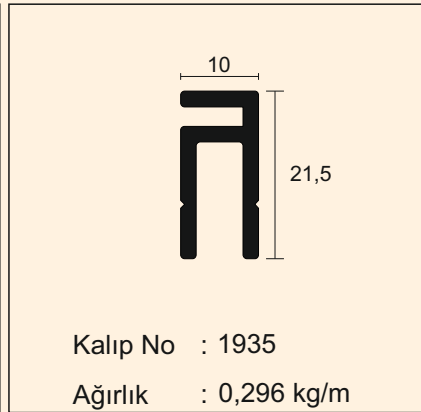
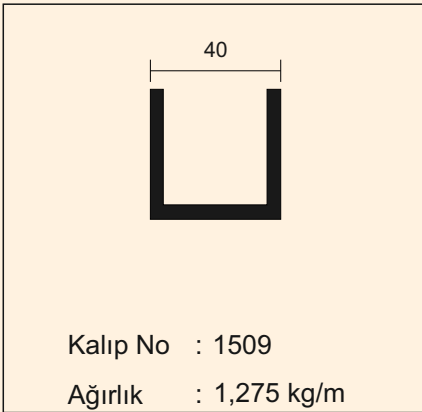
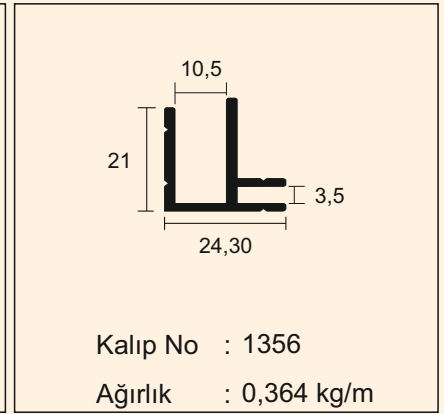
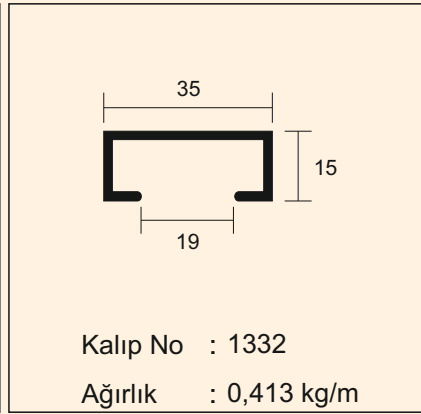
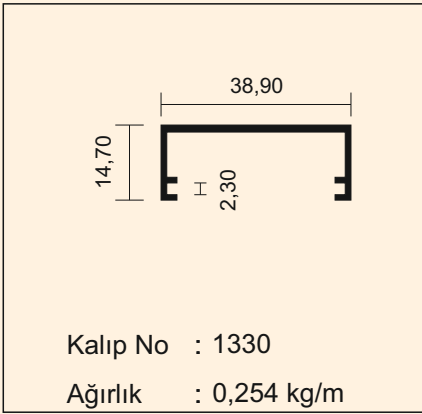
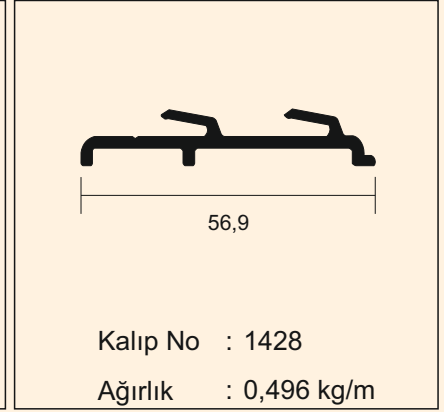
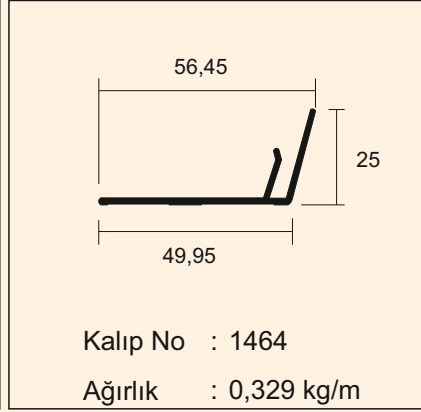
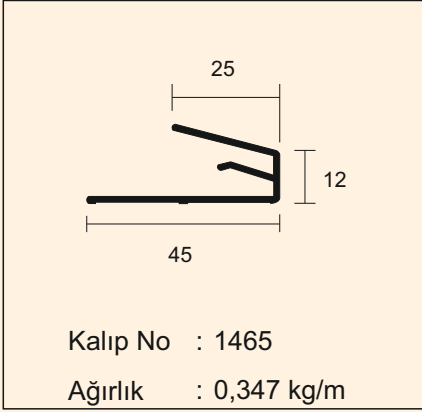

Katalogumuzda bulunan profil çizimleri örnek olarak konulmuştur. Müşterilerimize ait olan çizimlerin profilleri satılamaz. Çizimler üzerinden ölçü almayınız. Resimlerin altında yer alan profil ağırlığı bilgi amaçlı olup, ürünlerin teslim anındaki tartımız ağırlığı geçerlidir.

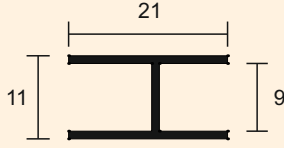

Kalıp No : 1869

Ağırlık : 0,145 kg/m

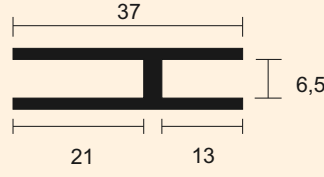

Kalıp No : 1014

Ağırlık : 0,354 kg/m

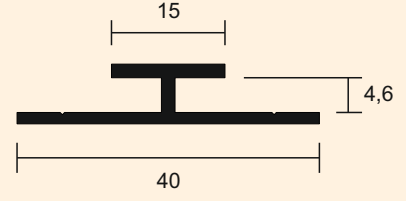

Kalıp No : 1929

Ağırlık : 0,271 kg/m

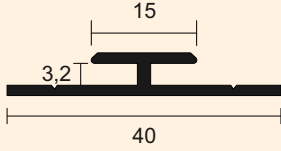

Kalıp No : 1577

Ağırlık : 0,248 kg/m

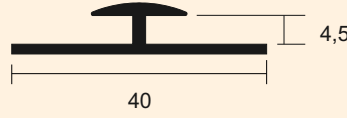

Kalıp No : 1127

Ağırlık : 0,261 kg/m

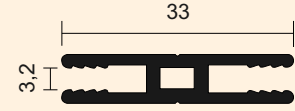

Kalıp No : 1514

Ağırlık : 0,356 kg/m

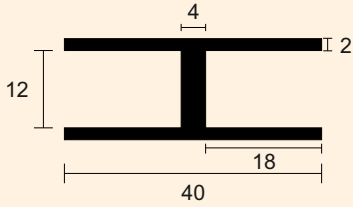

Kalıp No : 1607

Ağırlık : 0,592 kg/m

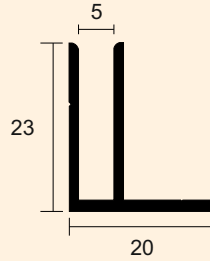

Kalıp No : 1674

Ağırlık : 0,228 kg/m

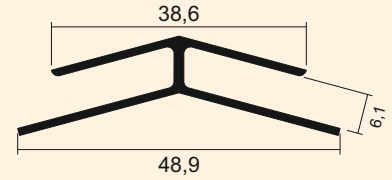

Kalıp No : 2557

Ağırlık : 0,310 kg/m

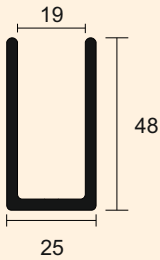

Kalıp No : 1608

Ağırlık : 0,976 kg/m

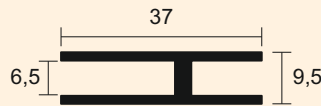

Kalıp No : 2496

Ağırlık : 0,371 kg/m

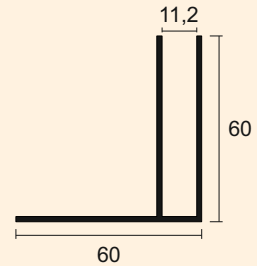

Kalıp No : 2500

Ağırlık : 0,838 kg/m

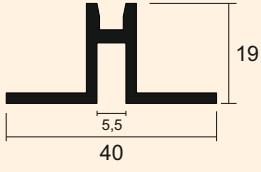

Kalıp No : 2303
Ağırlık : 0,440 kg/m

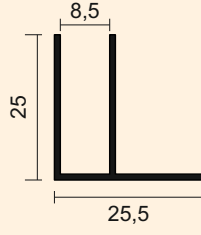

Kalıp No : 2594
Ağırlık : 0,209 kg/m

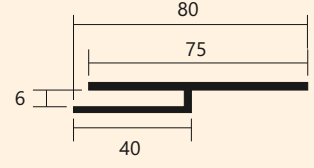

Kalıp No : 5198
Ağırlık : 0,795 kg/m

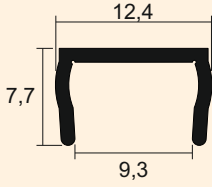

Kalıp No : 2470
Ağırlık : 0,070 kg/m

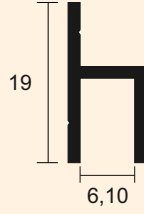

Kalıp No : 1301
Ağırlık : 0,144 kg/m

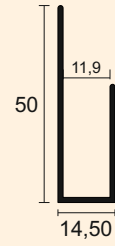

Kalıp No : 2586
Ağırlık : 0,339 kg/m

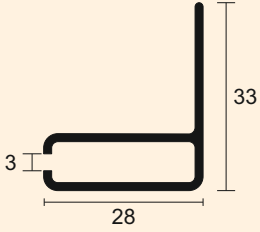

Kalıp No : 2517
Ağırlık : 0,335 kg/m

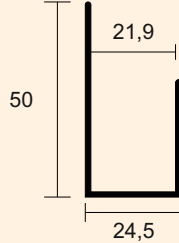

Kalıp No : 1617
Ağırlık : 0,376 kg/m

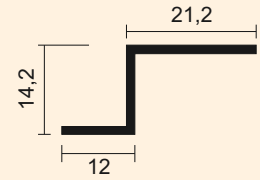

Kalıp No : 1415
Ağırlık : 0,154 kg/m

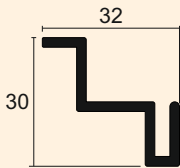

Kalıp No : 2478
Ağırlık : 0,462 kg/m

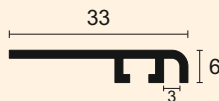

Kalıp No : 2487
Ağırlık : 0,170 kg/m

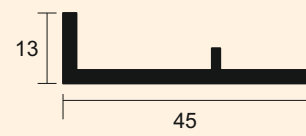

Kalıp No : 2488
Ağırlık : 0,392 kg/m

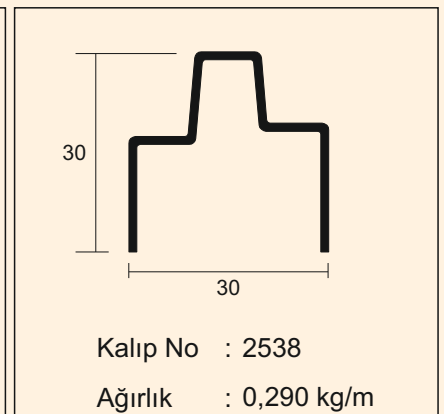
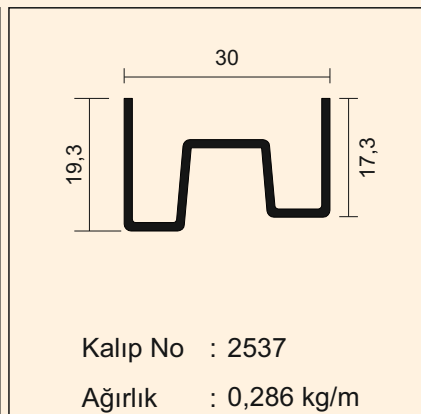
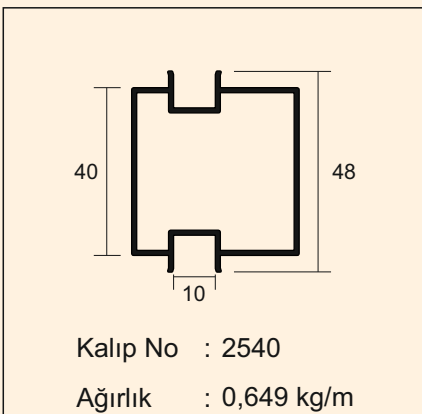
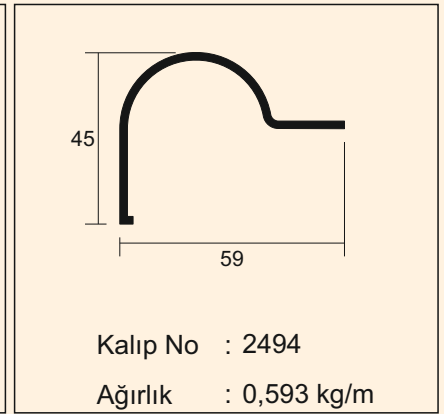
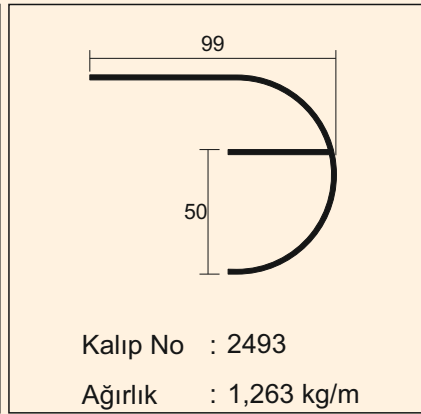
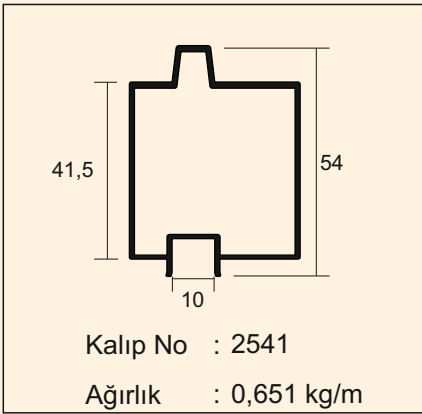
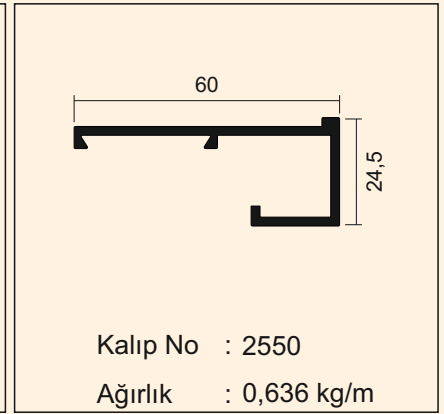
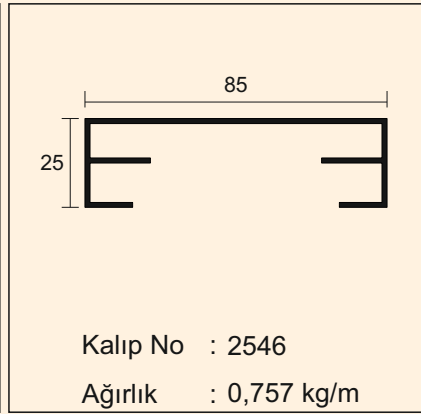
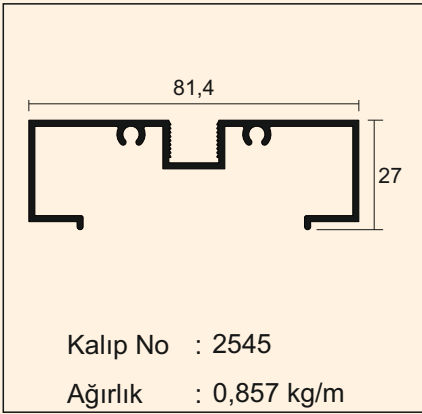
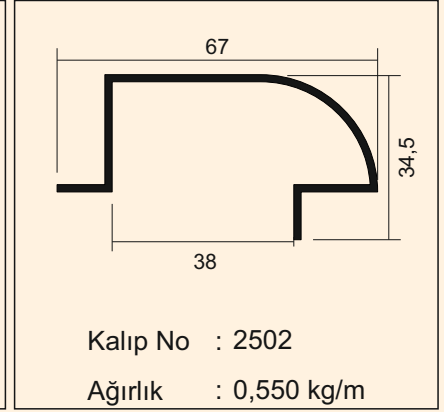
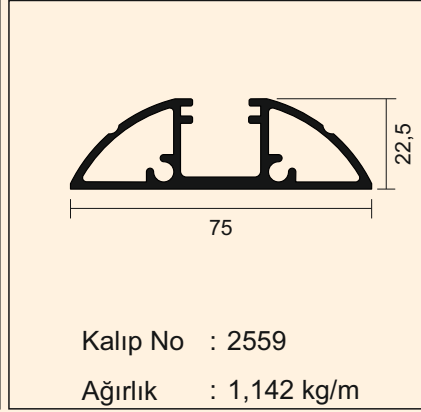
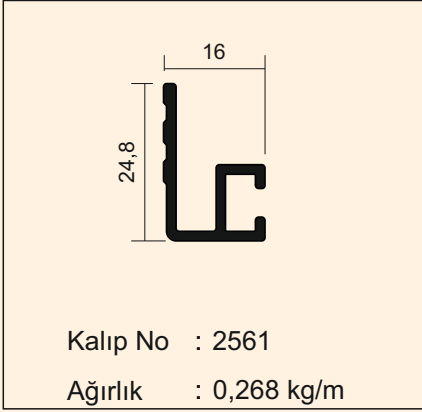

Kataloğumuzda bulunan profil çizimleri örnek olarak konulmuştur. Müşterilerimize ait olan çizimlerin profilleri satılamaz. Çizimler üzerinden ölçü almayınız. Resimlerin altında yer alan profil ağırlığı bilgi amaçlı olup, ürünlerin teslim anındaki tartımız ağırlığı geçerlidir.

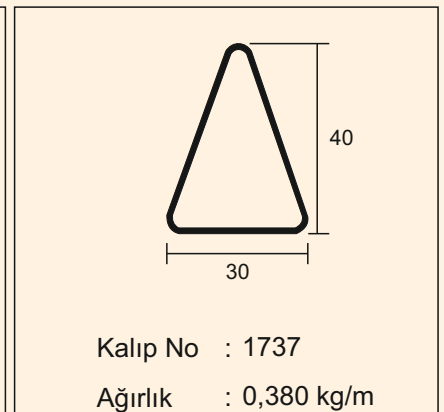
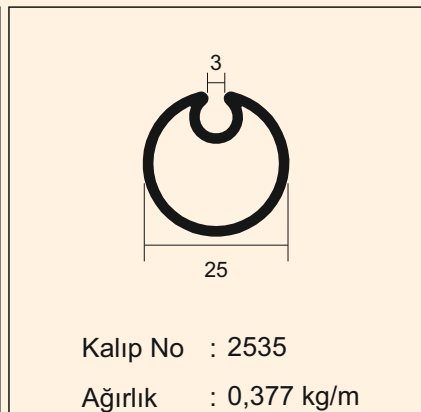
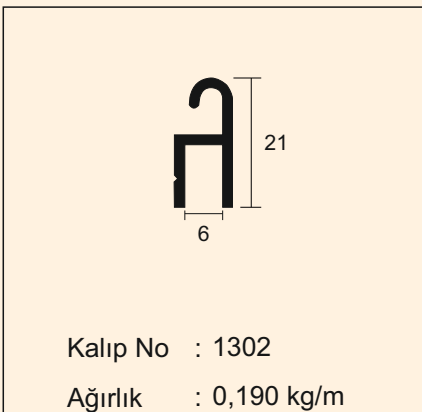
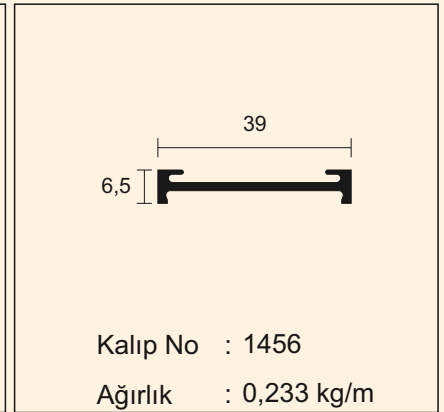
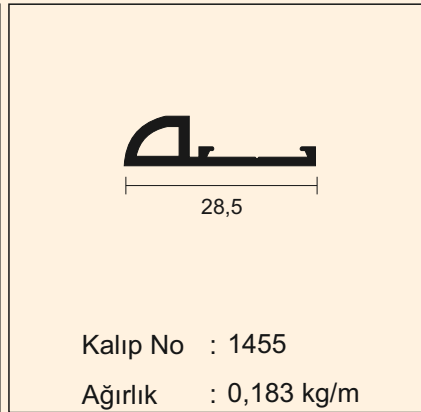
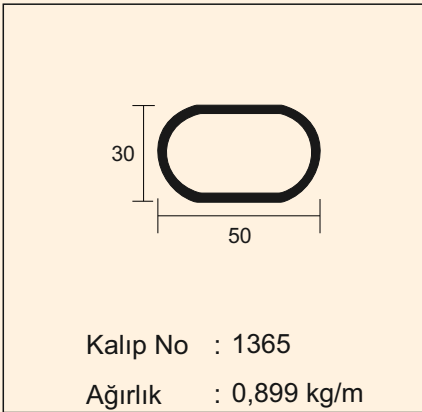
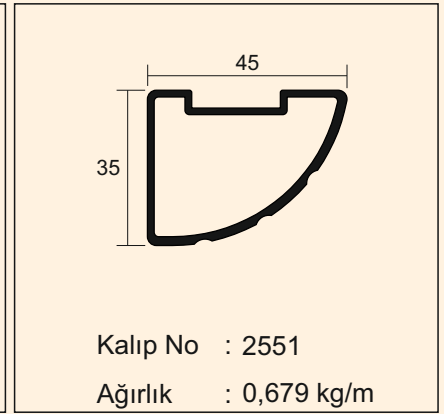
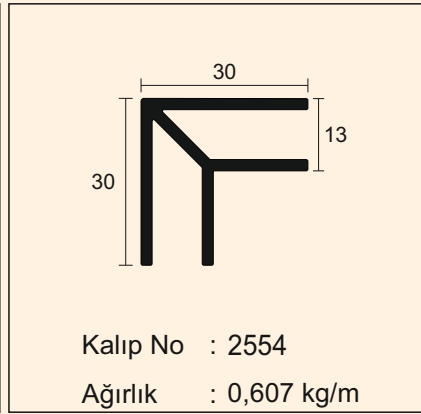
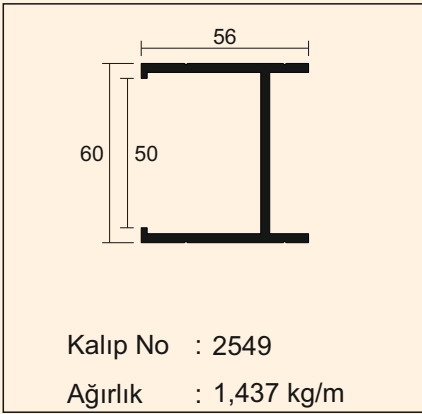
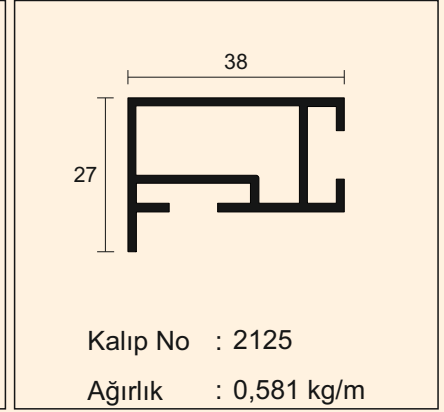
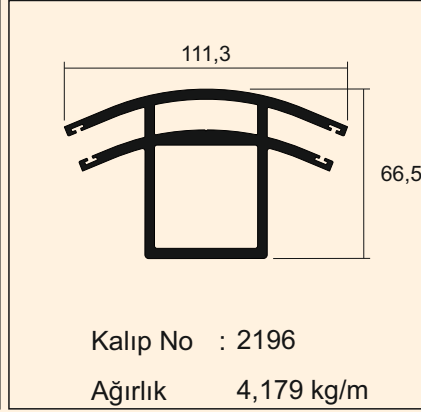
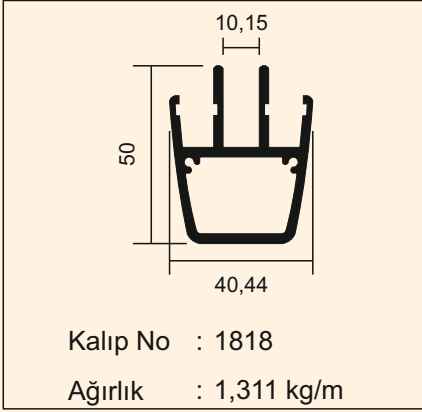

Kataloğumuzda bulunan profil çizimleri örnek olarak konulmuştur. Müşterilerimize ait olan çizimlerin profilleri satılamaz. Çizimler üzerinden ölçü almayınız. Resimlerin altında yer alan profil ağırlığı bilgi amaçlı olup, ürünlerin teslim anındaki tartımız ağırlığı geçerlidir.

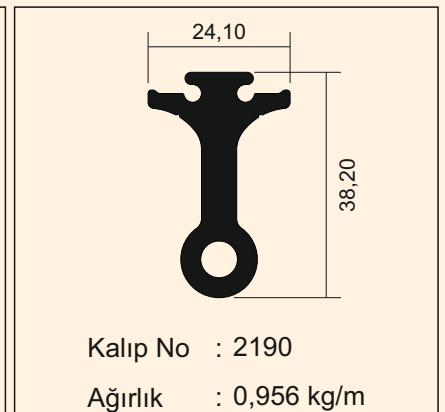
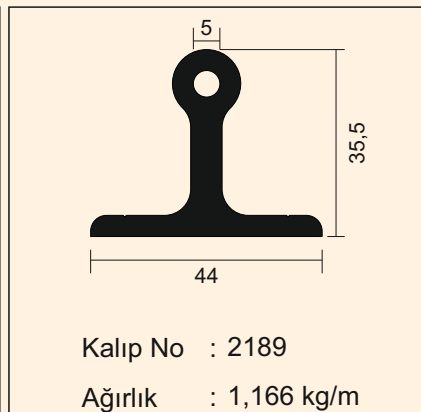
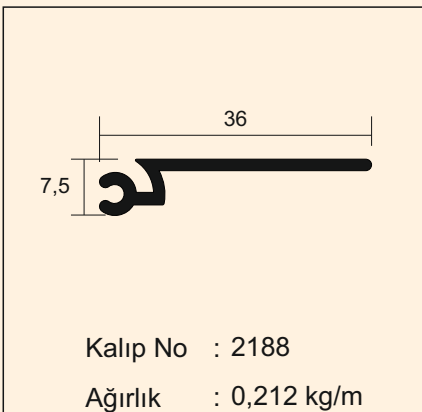
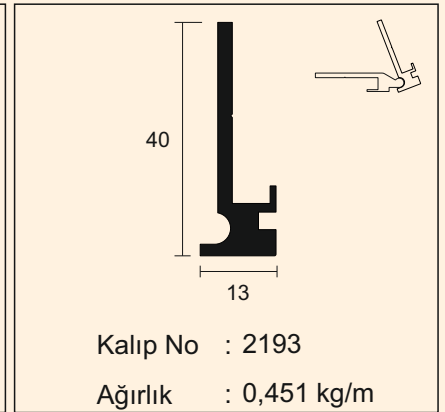
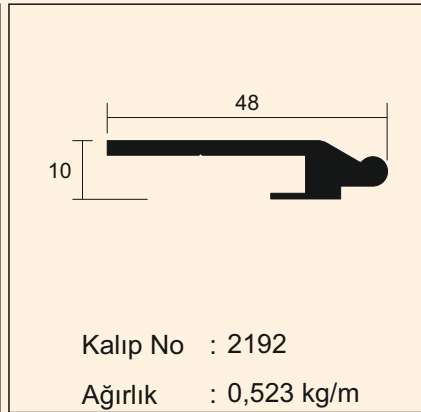
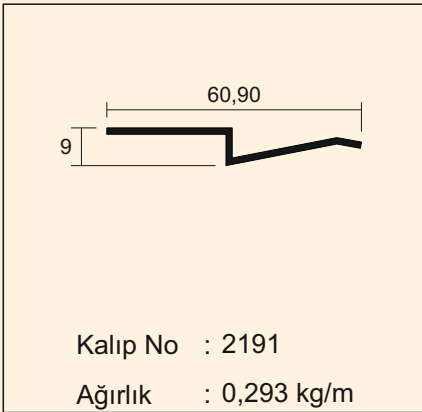
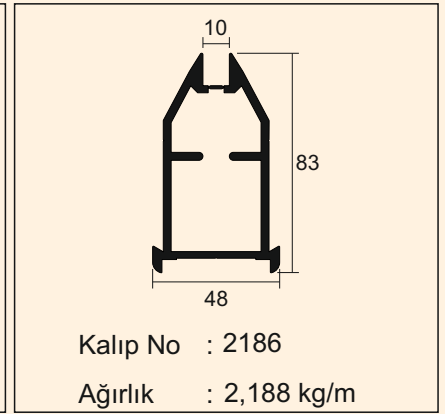
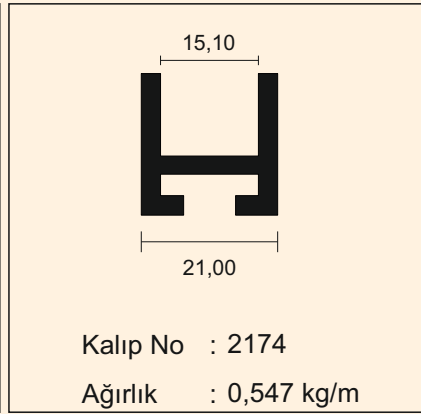
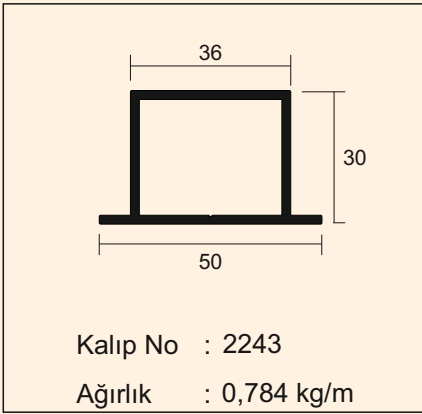
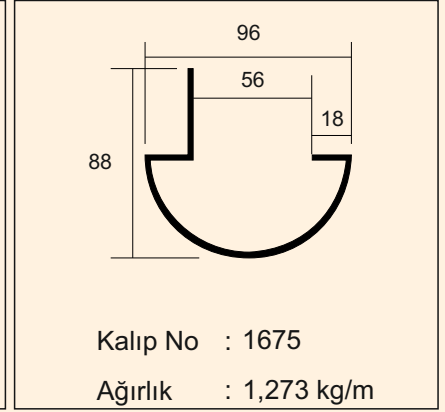
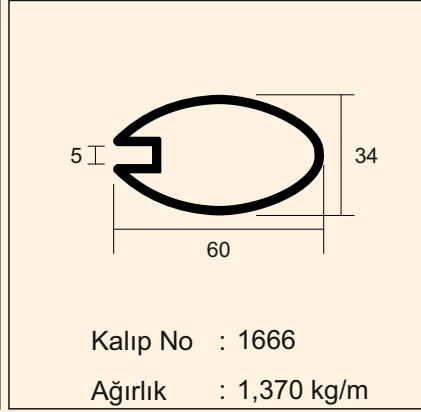
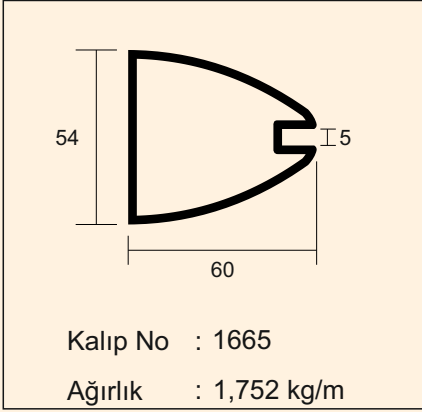

Katalogumuzda bulunan profil çizimleri örnek olarak konulmuştur. Müşterilerimize ait olan çizimlerin profilleri satılamaz. Çizimler üzerinden ölçü almayınız. Resimlerin altında yer alan profil ağırlığı bilgi amaçlı olup, ürünlerin teslim anındaki tartımız ağırlığı geçerlidir.

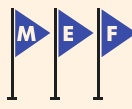

çözümün bir parçasıyız

MEF METAL

to be a part of solution

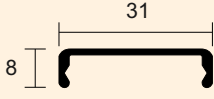

Kalıp No : 1259

Ağırlık : 0,189 kg/m

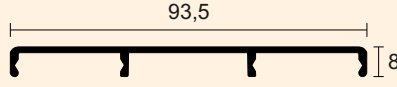

Kalıp No : 1260

Ağırlık : 0,522 kg/m

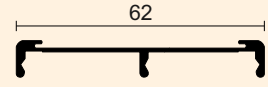

Kalıp No : 1624

Ağırlık : 0,292 kg/m

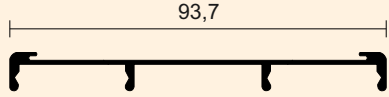

Kalıp No : 1625

Ağırlık : 0,481 kg/m

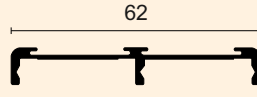

Kalıp No : 1626

Ağırlık : 0,310 kg/m

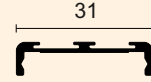

Kalıp No : 1627

Ağırlık : 0,170 kg/m

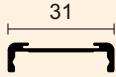

Kalıp No : 1628

Ağırlık : 0,182 kg/m

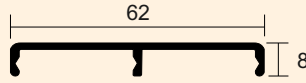

Kalıp No : 1347

Ağırlık : 0,353 kg/m

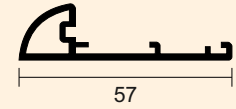

Kalıp No : 1629

Ağırlık : 0,433 kg/m

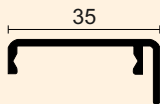

Kalıp No : 1631

Ağırlık : 0,265 kg/m

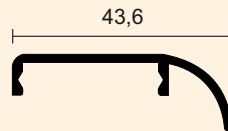

Kalıp No : 1630

Ağırlık : 0,276 kg/m

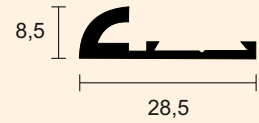

Kalıp No : 1597

Ağırlık : 0,203 kg/m

Katalogümüzda bulunan profil çizimleri örnek olarak konulmuştur. Müşterilerimize ait olan çizimlerin profilleri satılamaz. Çizimler üzerinden ölçü almayınız. Resimlerin altında yer alan profil ağırlığı bilgi amaçlı olup, ürünlerin teslim anındaki tartımız ağırlığı geçerlidir.

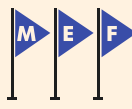

çözümün bir parçasıyız

MEF METAL

to be a part of solution

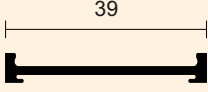

Kalıp No : 1632
Ağırlık : 0,212 kg/m

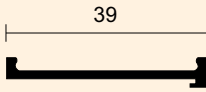

Kalıp No : 1633
Ağırlık : 0,201 kg/m

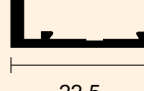

Kalıp No : 1634
Ağırlık : 0,129 kg/m

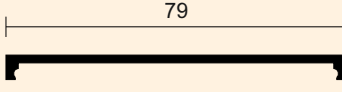

Kalıp No : 1635
Ağırlık : 0,383 kg/m

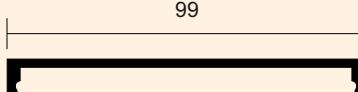

Kalıp No : 1636
Ağırlık : 0,468 kg/m

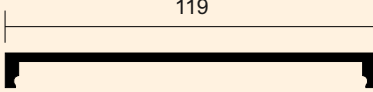

Kalıp No : 1637
Ağırlık : 0,554 kg/m

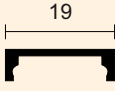

Kalıp No : 1638
Ağırlık : 0,127 kg/m

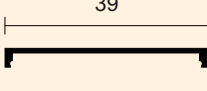

Kalıp No : 1639
Ağırlık : 0,212 kg/m

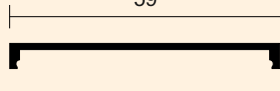

Kalıp No : 1640
Ağırlık : 0,298 kg/m

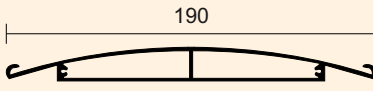

Kalıp No : 1641
Ağırlık : 1,661 kg/m

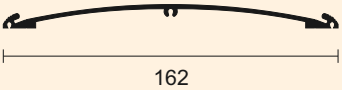

Kalıp No : 1403
Ağırlık : 1,006 kg/m

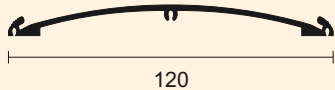

Kalıp No : 1404
Ağırlık : 0,809 kg/m

Kataloğumuzda bulunan profil çizimleri örnek olarak konulmuştur. Müşterilerimize ait olan çizimlerin profilleri satılamaz. Çizimler üzerinden ölçü almayınız. Resimlerin altında yer alan profil ağırlığı bilgi amaçlı olup, ürünlerin teslim anındaki tartımız ağırlığı geçerlidir.

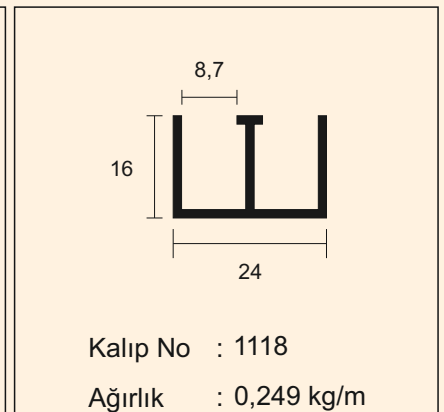
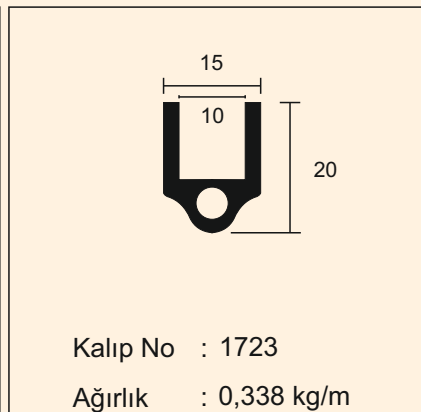
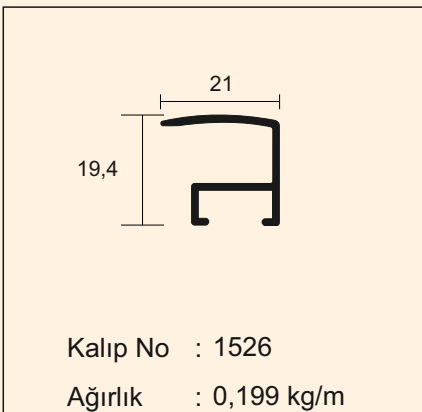
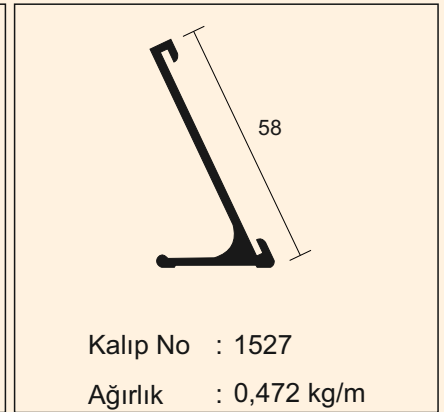
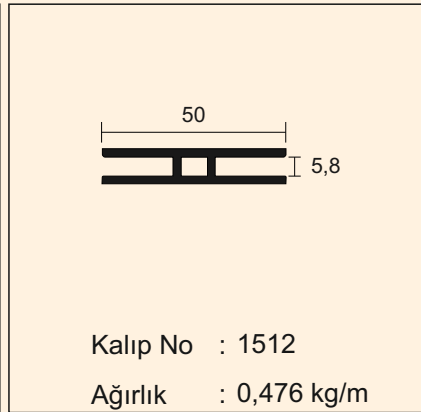
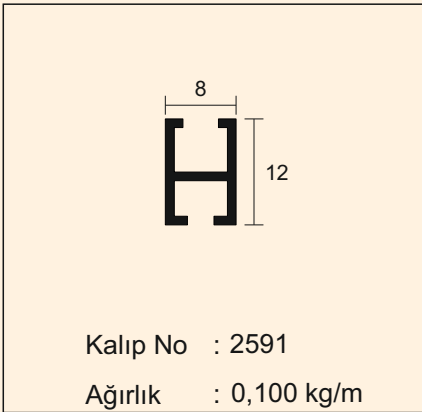
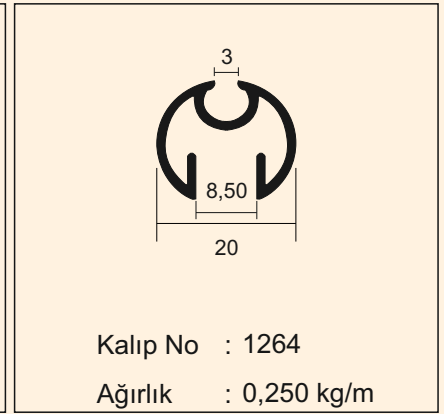
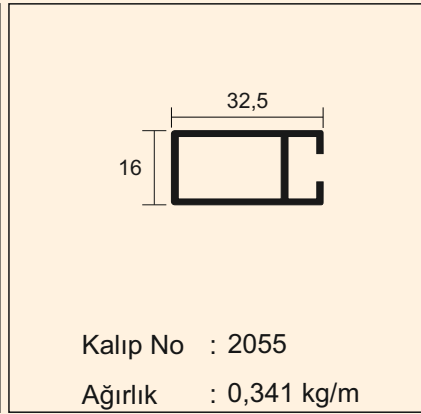
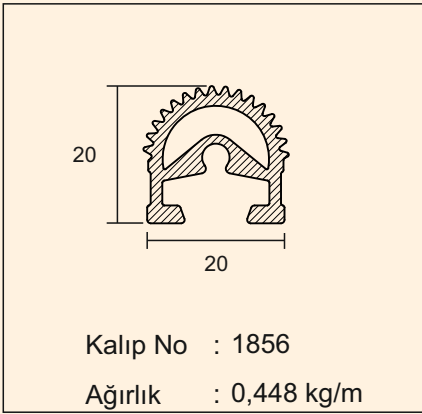
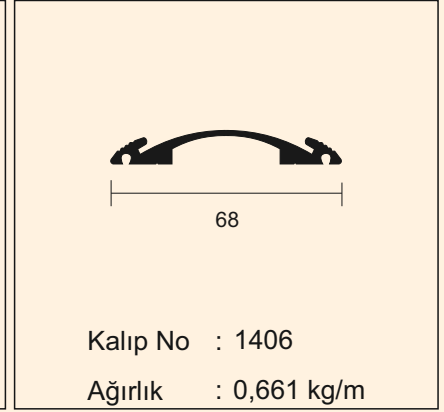
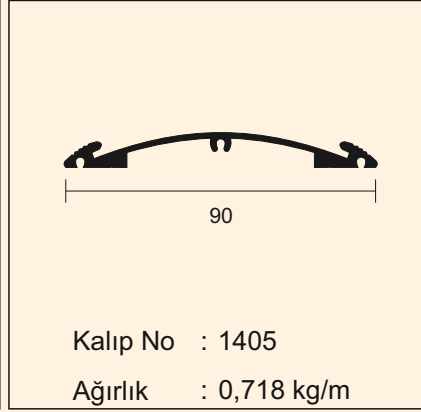
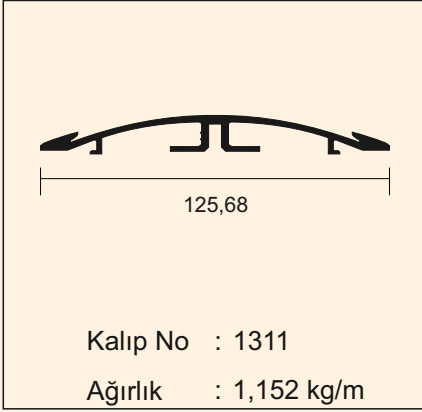

Kataloğumuzda bulunan profil çizimleri örnek olarak konulmuştur. Müşterilerimize ait olan çizimlerin profilleri satılamaz. Çizimler üzerinden ölçü almayınız. Resimlerin altında yer alan profil ağırlığı bilgi amaçlı olup, ürünlerin teslim anındaki tartımız ağırlığı geçerlidir.

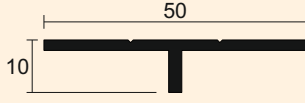

Kalıp No : 2598

Ağırlık : 0,340 kg/m

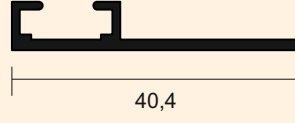

Kalıp No : 2613

Ağırlık : 0,230 kg/m

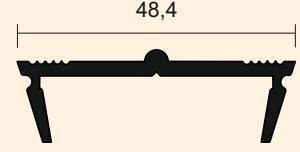

Kalıp No : 2504

Ağırlık : 0,472 kg/m

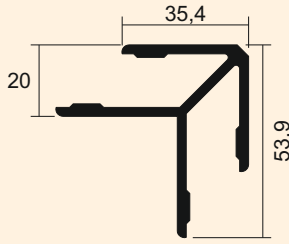

Kalıp No : 2523

Ağırlık : 1,218 kg/m

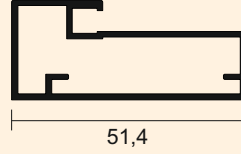

Kalıp No : 2605

Ağırlık : 0,586 kg/m

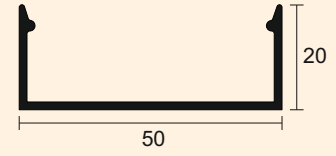

Kalıp No : 2503

Ağırlık : 0,384 kg/m

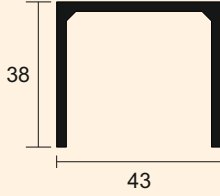

Kalıp No : 2548

Ağırlık : 0,829 kg/m

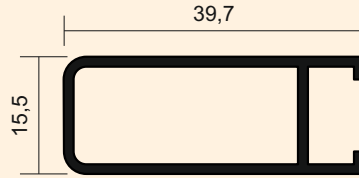

Kalıp No : 2508

Ağırlık : 0,394 kg/m

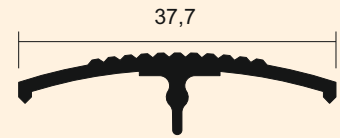

Kalıp No : 2505

Ağırlık : 0,232 kg/m

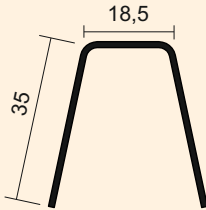

Kalıp No : 2510

Ağırlık : 0,290 kg/m

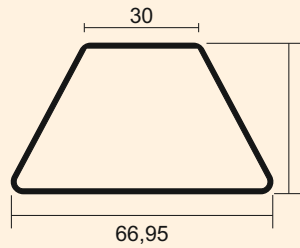

Kalıp No : 2509

Ağırlık : 0,571 kg/m

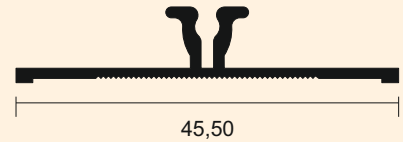

Kalıp No : 2506

Ağırlık : 0,219 kg/m

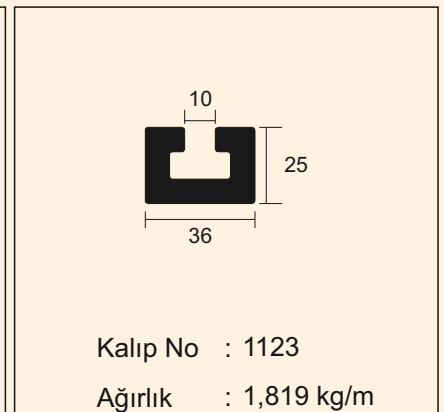
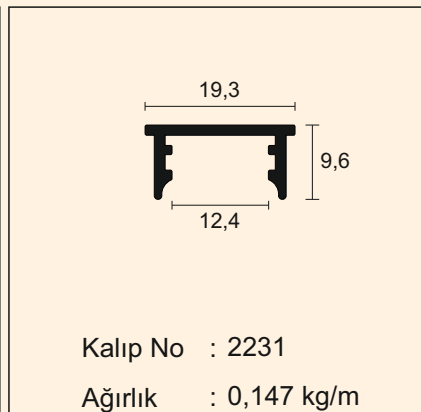
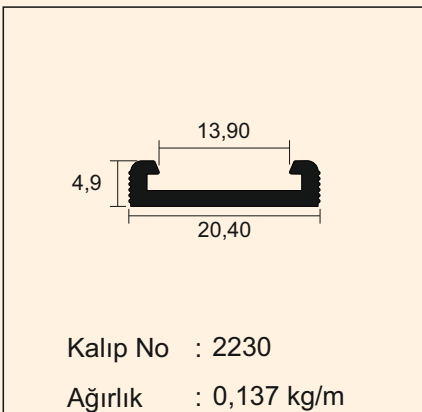
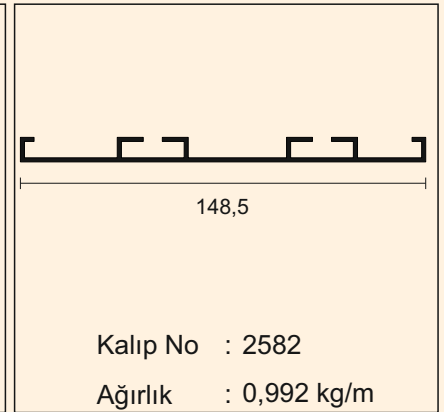
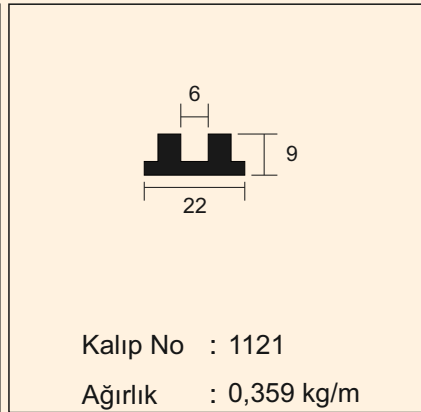
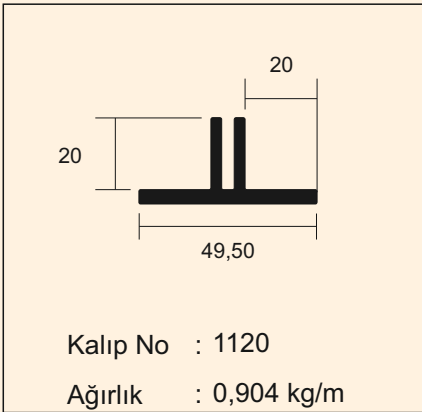
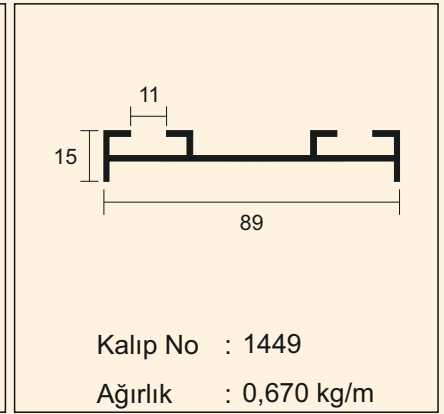
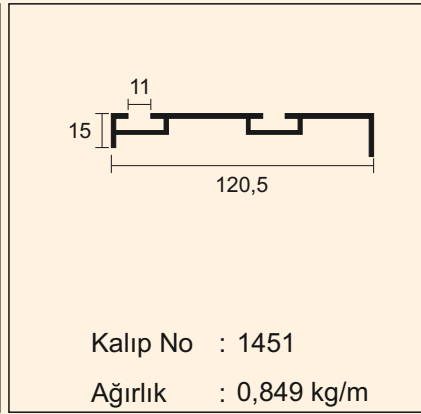
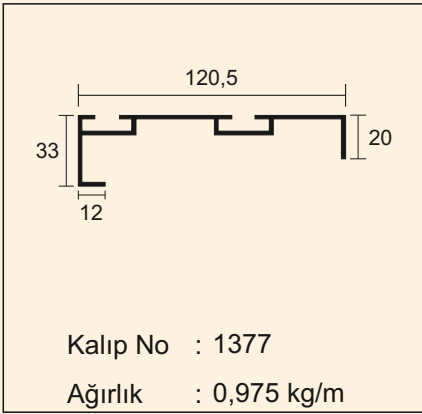
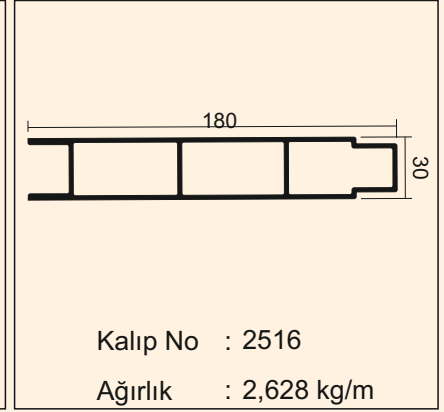
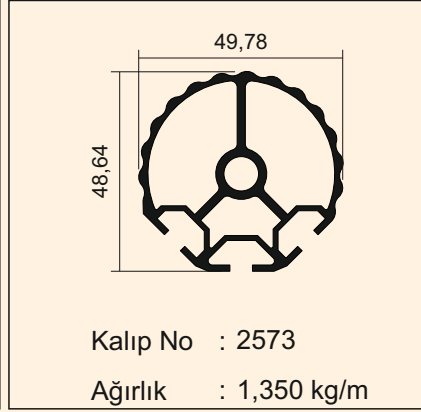
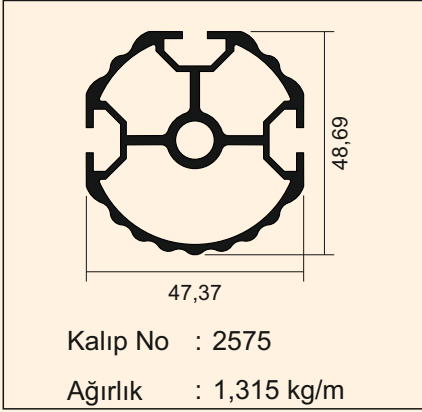

Katalogumuzda bulunan profil çizimleri örnek olarak konulmuştur. Müşterilerimize ait olan çizimlerin profilleri satılamaz. Çizimler üzerinden ölçü almayınız. Resimlerin altında yer alan profil ağırlığı bilgi amaçlı olup, ürünlerin teslim anındaki tartımız ağırlığı geçerlidir.

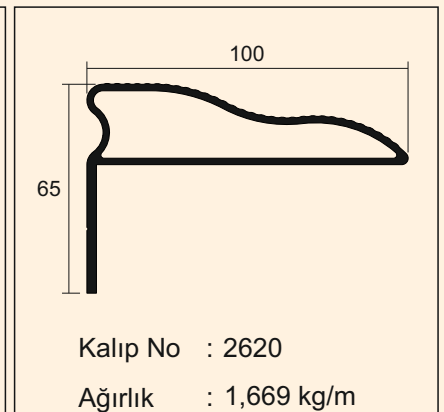
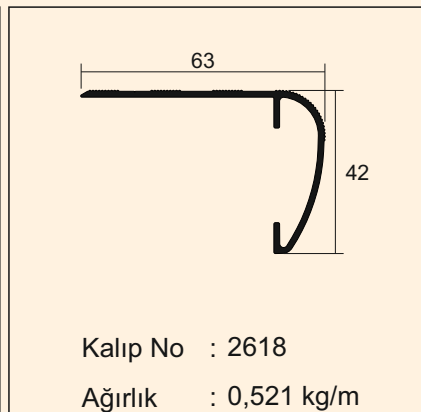
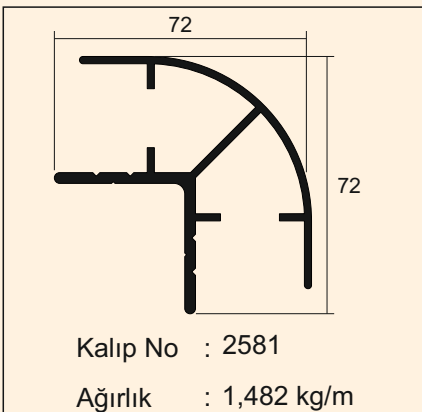
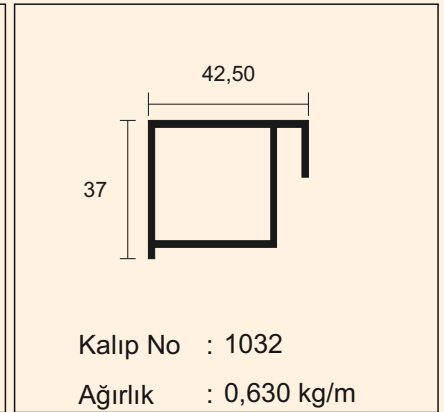
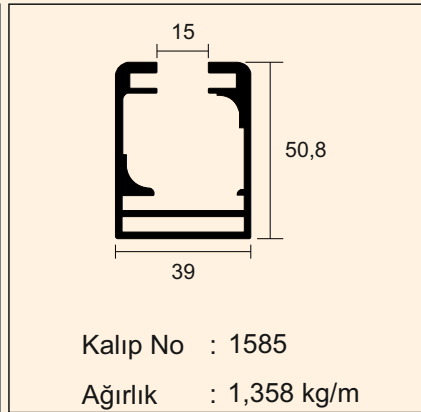
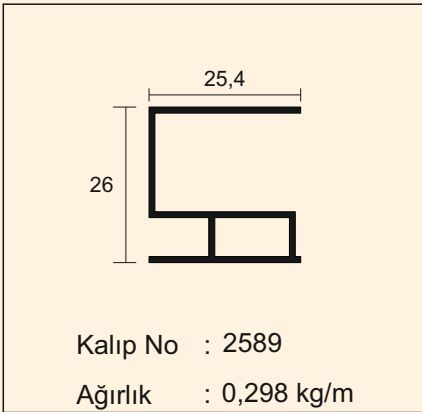
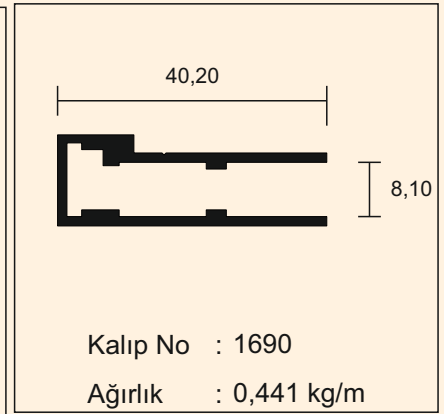
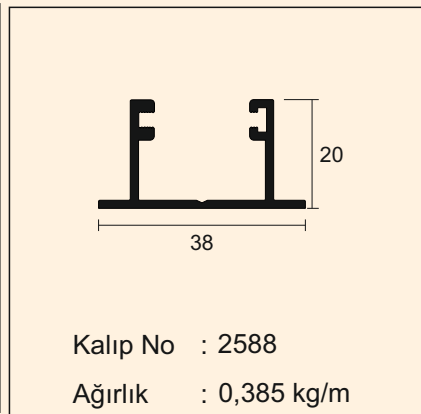
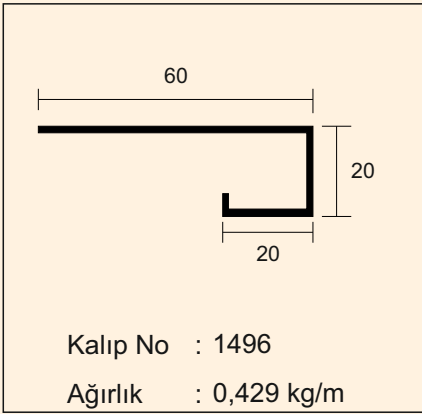
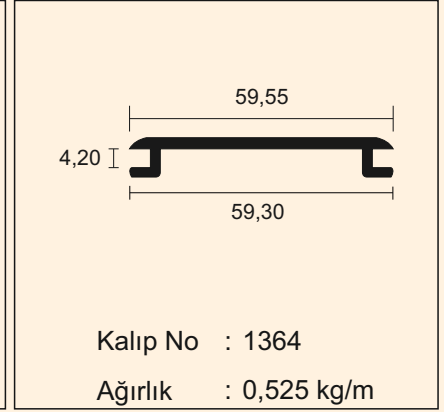
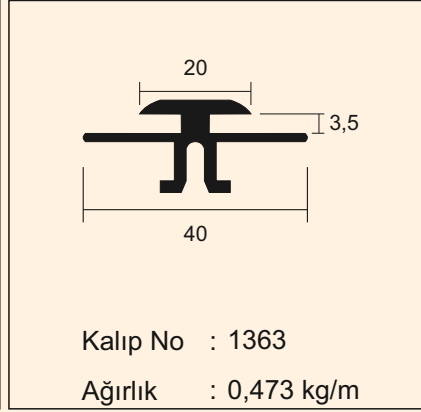
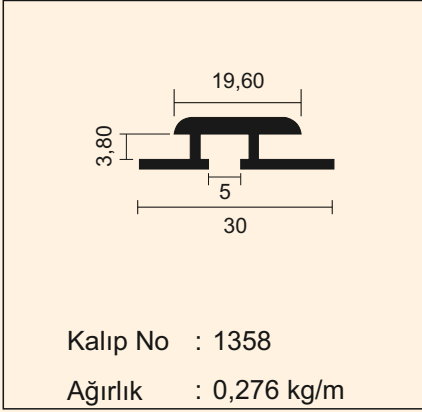

Kataloğumuzda bulunan profil çizimleri örnek olarak konulmuştur. Müşterilerimize ait olan çizimlerin profilleri satılamaz. Çizimler üzerinden ölçü almayınız. Resimlerin altında yer alan profil ağırlığı bilgi amaçlı olup, ürünlerin teslim anındaki tartımız ağırlığı geçerlidir.

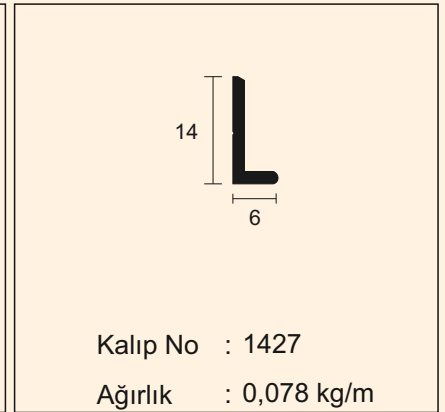
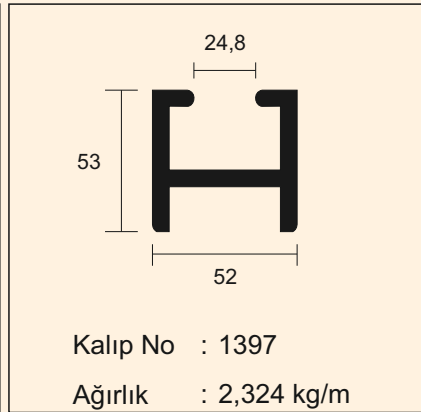
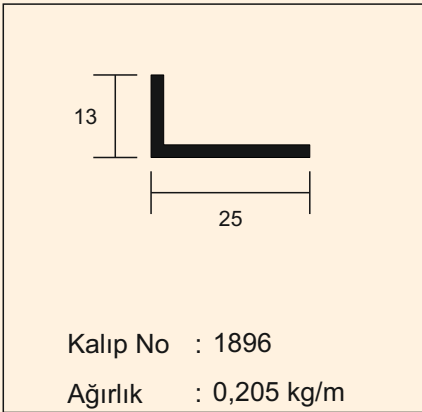
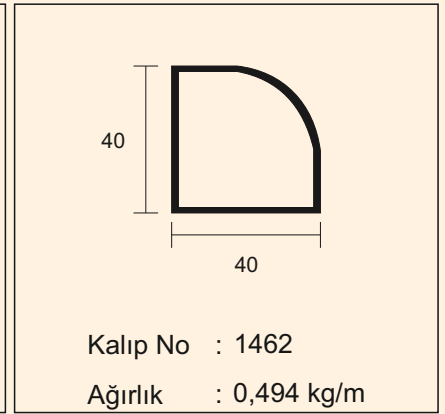
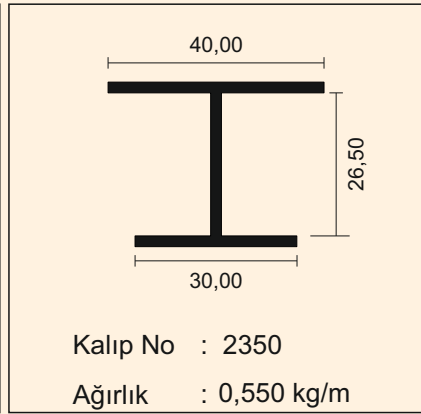
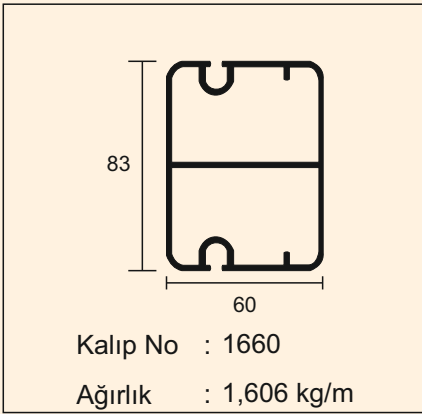
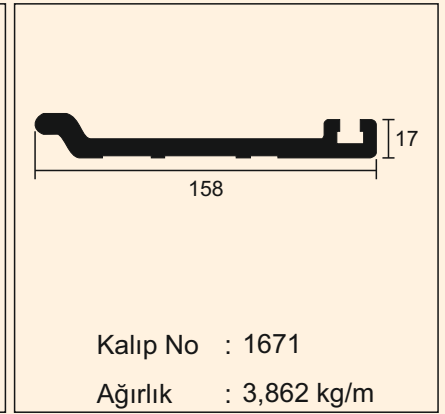
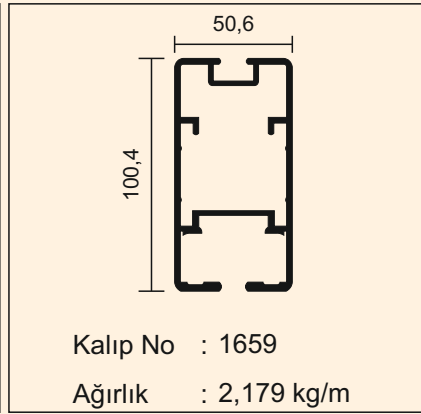
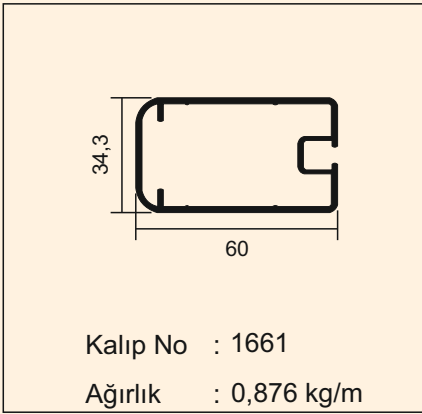
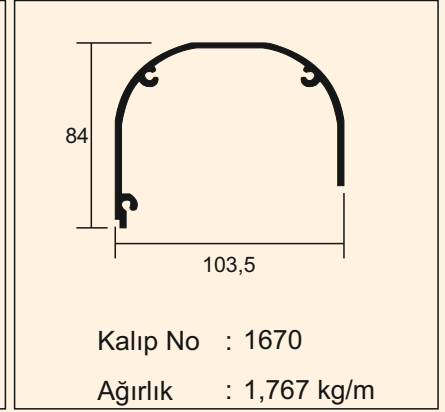
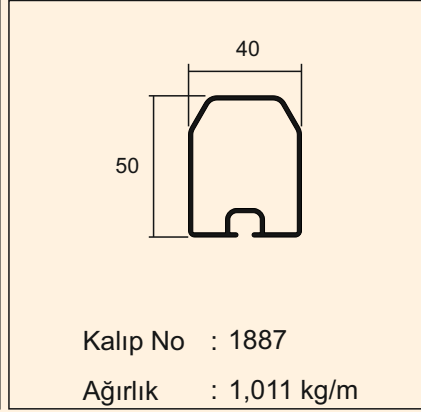
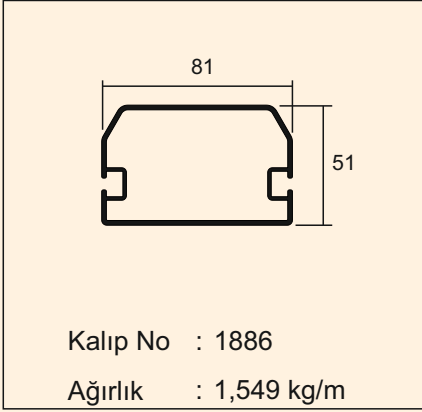

Kataloğumuzda bulunan profil çizimleri örnek olarak konulmuştur. Müşterilerimize ait olan çizimlerin profilleri satılamaz. Çizimler üzerinden ölçü almayınız. Resimlerin altında yer alan profil ağırlığı bilgi amaçlı olup, ürünlerin teslim anındaki tartımız ağırlığı geçerlidir.

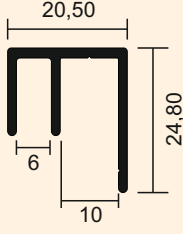

Kalıp No : 1953

Ağırlık : 0,309 kg/m

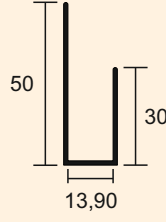

Kalıp No : 1954

Ağırlık : 0,346 kg/m

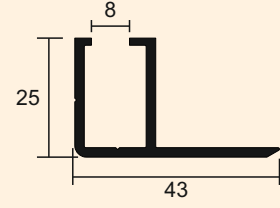

Kalıp No : 1955

Ağırlık : 0,518 kg/m

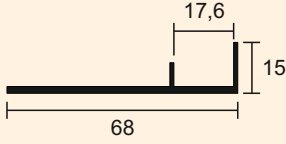

Kalıp No : 2061

Ağırlık : 0,460 kg/m

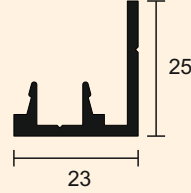

Kalıp No : 1877

Ağırlık : 0,352 kg/m

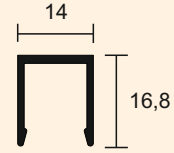

Kalıp No : 1878

Ağırlık : 0,167 kg/m

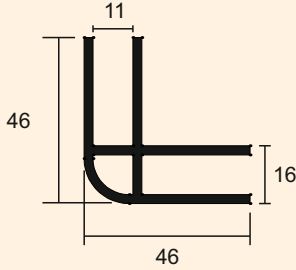

Kalıp No : 1872

Ağırlık : 1,203 kg/m

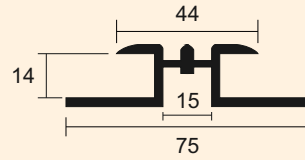

Kalıp No : 1239

Ağırlık : 0,992 kg/m

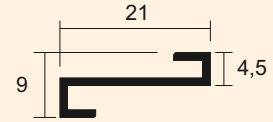

Kalıp No : 1473

Ağırlık : 0,104 kg/m

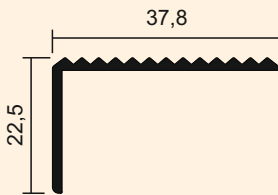

Kalıp No : 1950

Ağırlık : 0,260 kg/m

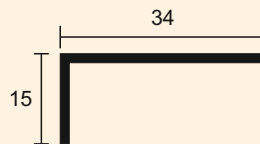

Kalıp No : 1945

Ağırlık : 0,202 kg/m

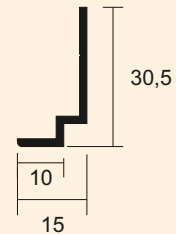

Kalıp No : 1479

Ağırlık : 0,187 kg/m

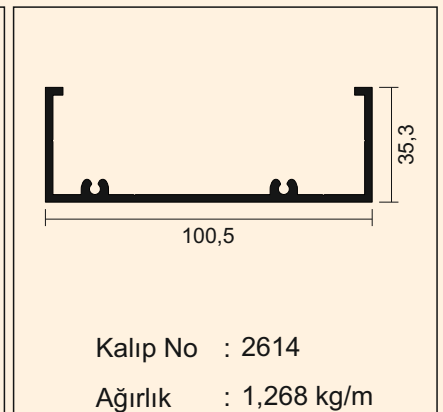
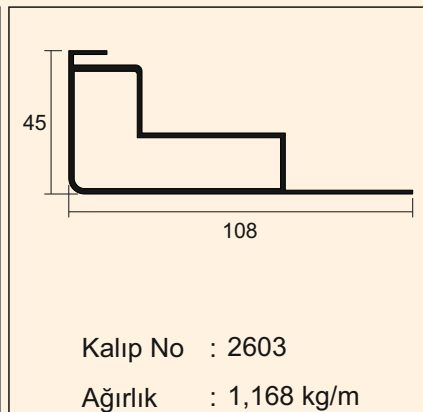
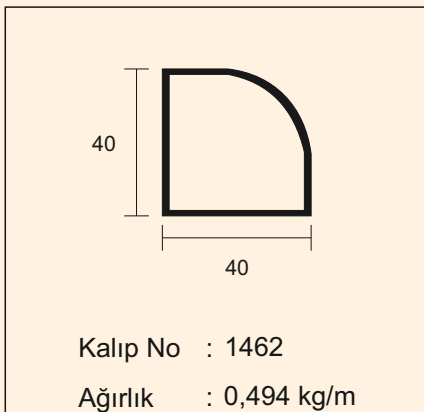
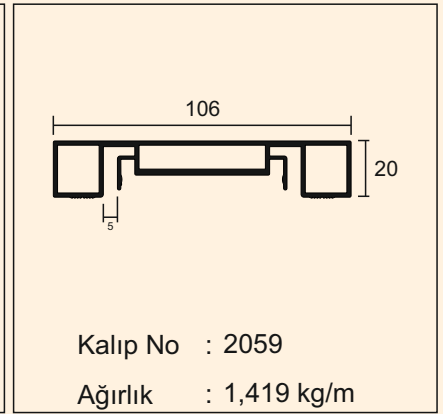
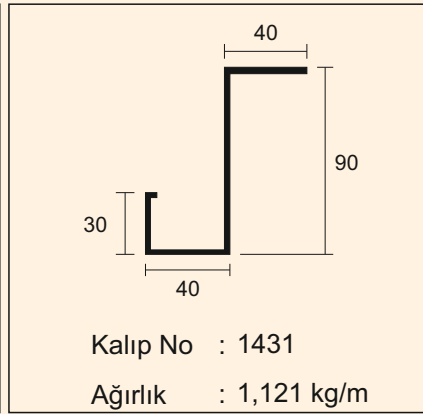
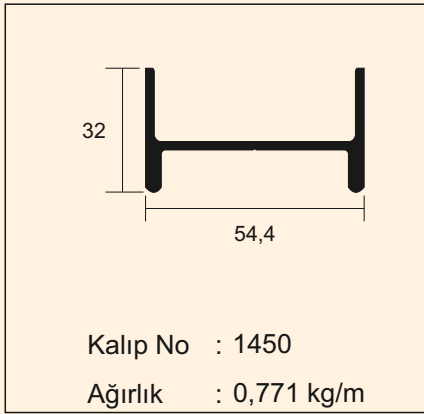
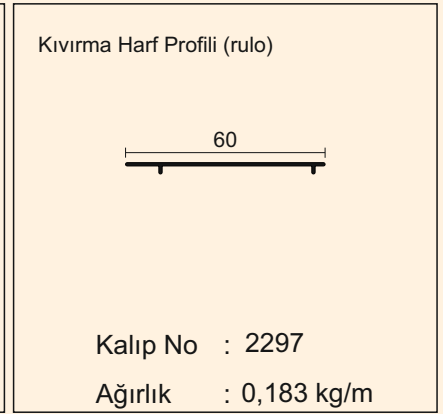
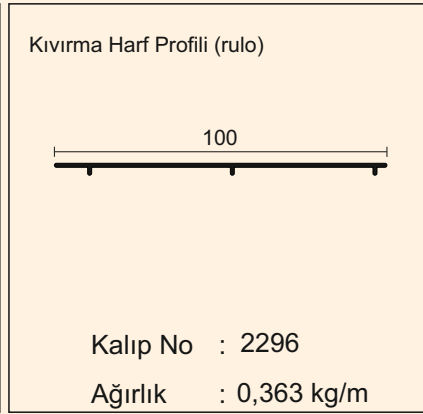
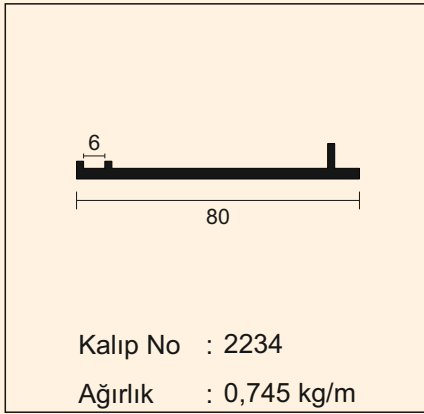
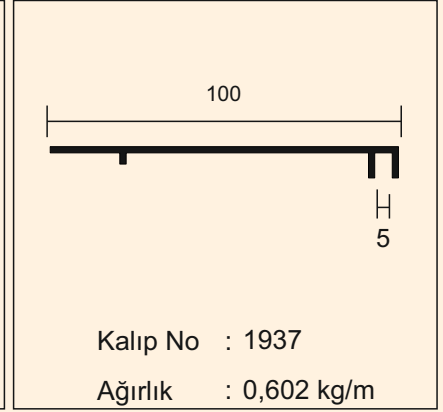
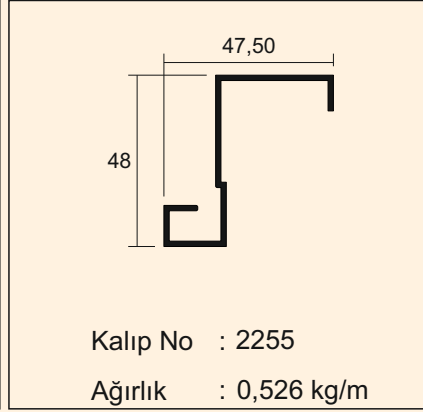
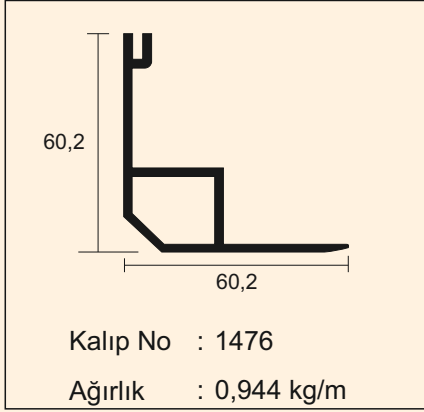

Katalogumuzda bulunan profil çizimleri örnek olarak konulmuştur. Müşterilerimize ait olan çizimlerin profilleri satılamaz. Çizimler üzerinden ölçü almayınız. Resimlerin altında yer alan profil ağırlığı bilgi amaçlı olup, ürünlerin teslim anındaki tartımız ağırlığı geçerlidir.

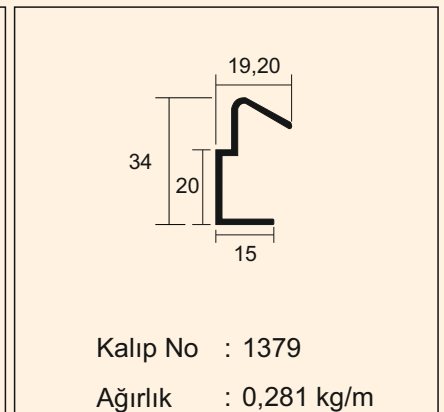
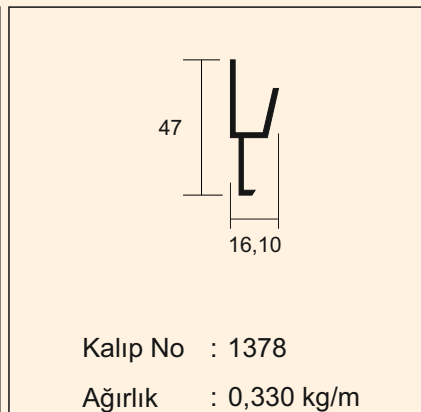
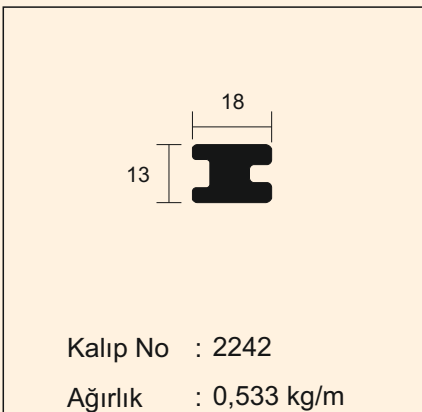
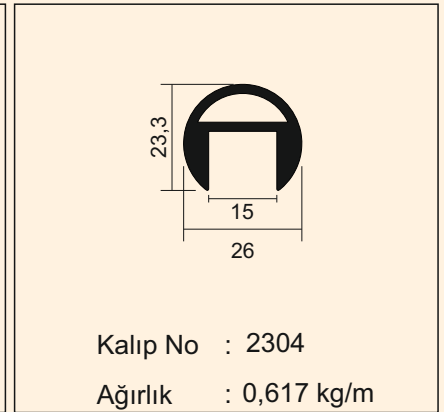
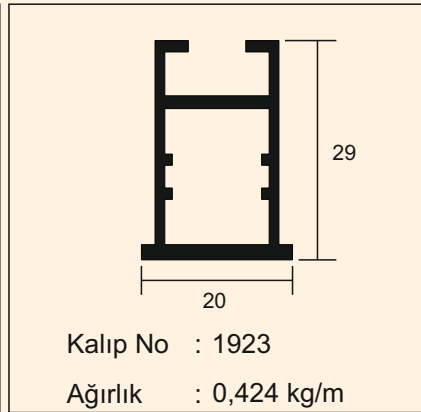
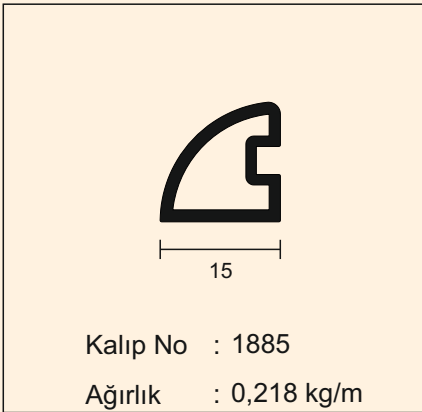
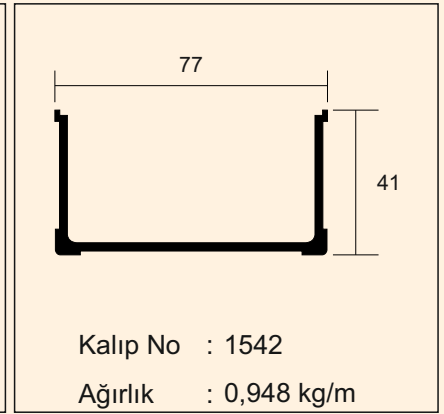
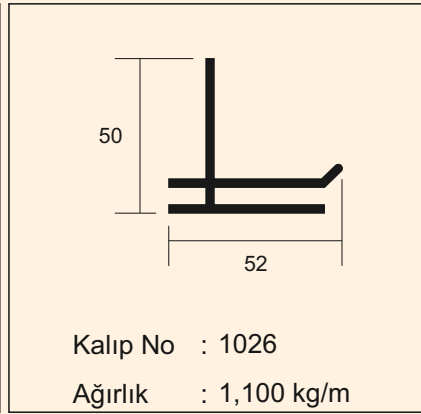
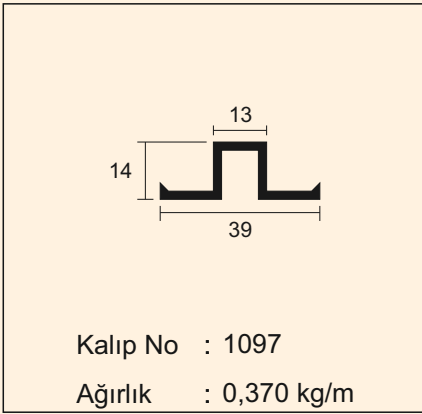
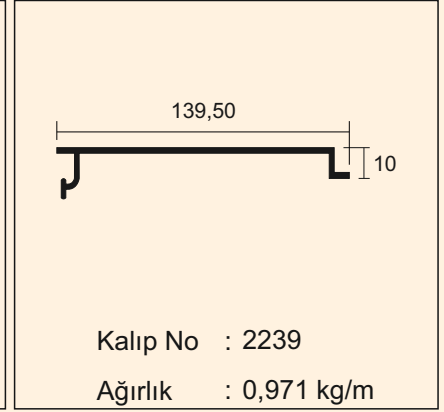
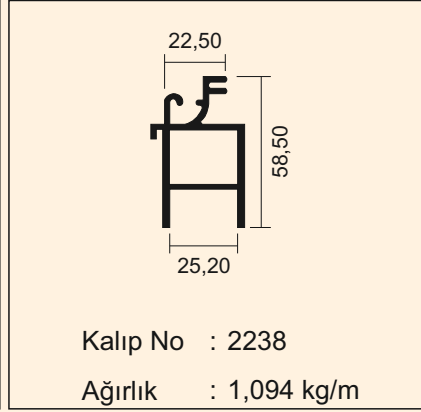
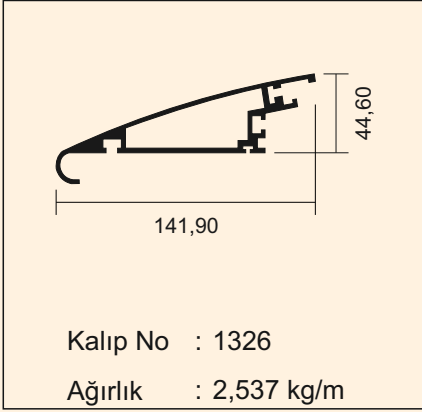

Kataloğumuzda bulunan profil çizimleri örnek olarak konulmuştur. Müşterilerimize ait olan çizimlerin profilleri satılamaz. Çizimler üzerinden ölçü almayınız. Resimlerin altında yer alan profil ağırlığı bilgi amaçlı olup, ürünlerin teslim anındaki tartımız ağırlığı geçerlidir.

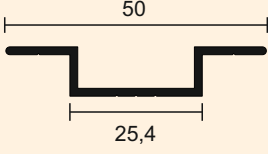

Kalıp No : 2071

Ağırlık : 0,279 kg/m

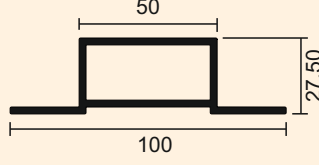

Kalıp No : 2070

Ağırlık : 1,385 kg/m

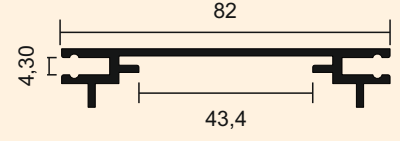

Kalıp No : 1911

Ağırlık : 0,781 kg/m

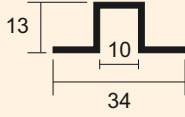

Kalıp No : 1093

Ağırlık : 0,243 kg/m

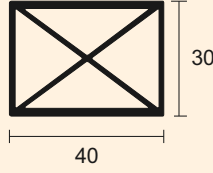

Kalıp No : 1457

Ağırlık : 0,970 kg/m

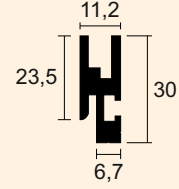

Kalıp No : 1574

Ağırlık : 0,539 kg/m

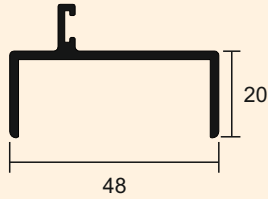

Kalıp No : 1870

Ağırlık : 0,552 kg/m

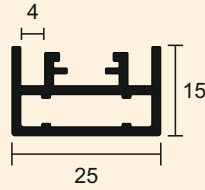

Kalıp No : 1930

Ağırlık : 0,395 kg/m

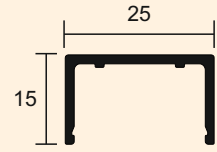

Kalıp No : 1931

Ağırlık : 0,225 kg/m

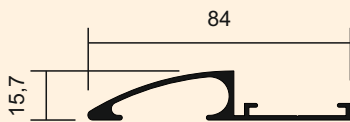

Kalıp No : 1662

Ağırlık : 0,626 kg/m

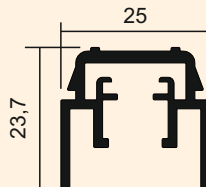

Kalıp No : 1932

Ağırlık : 0,463 kg/m

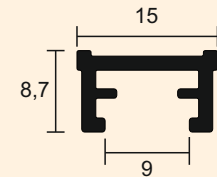

Kalıp No : 1933

Ağırlık : 0,146 kg/m

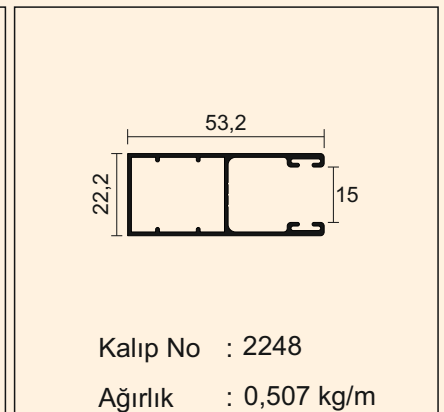
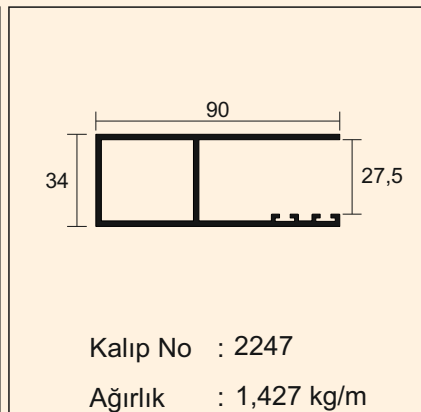
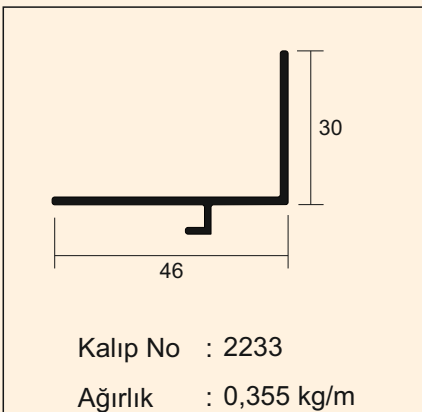
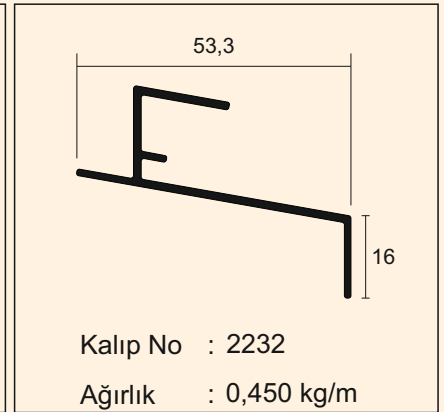
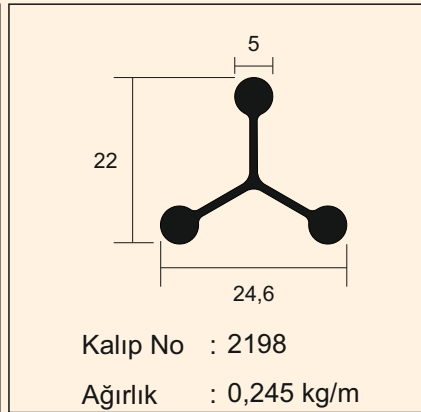
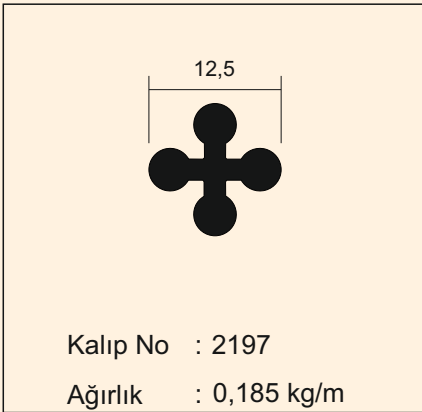
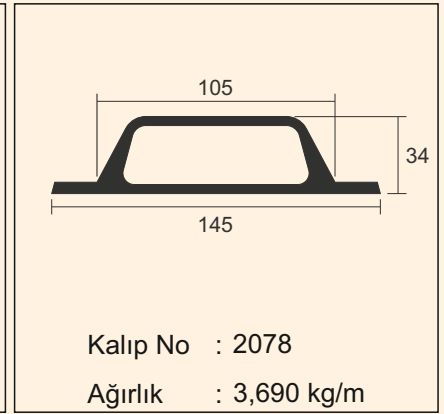
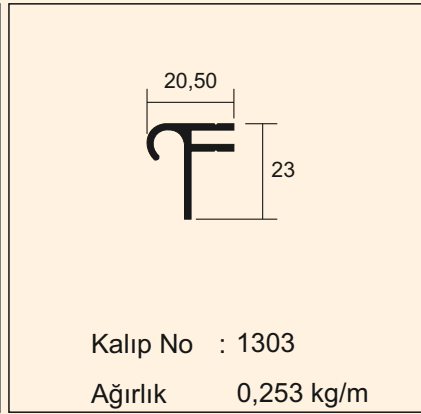
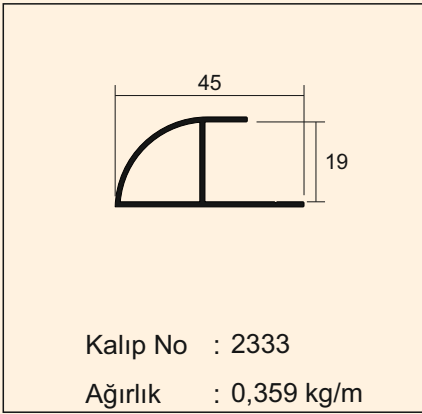
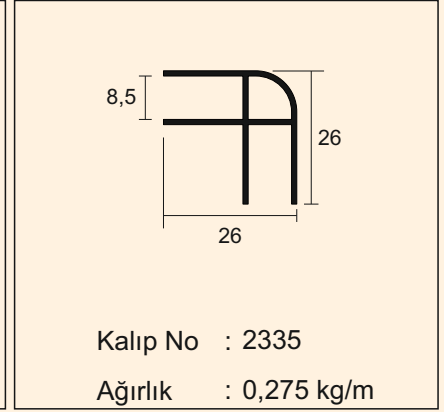
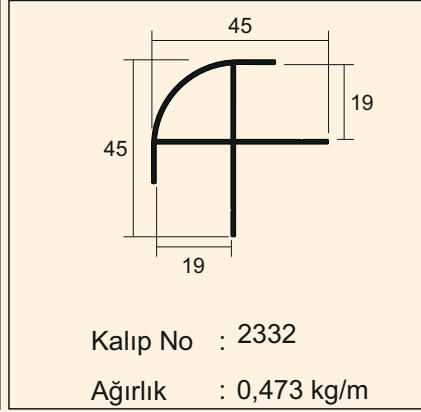
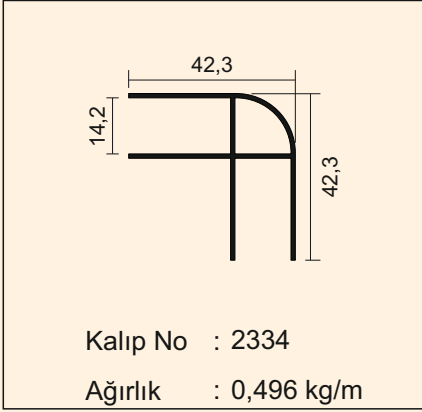

Katalogumuzda bulunan profil çizimleri örnek olarak konulmuştur. Müşterilerimize ait olan çizimlerin profilleri satılamaz. Çizimler üzerinden ölçü almayınız. Resimlerin altında yer alan profil ağırlığı bilgi amaçlı olup, ürünlerin teslim anındaki tartımız ağırlığı geçerlidir.

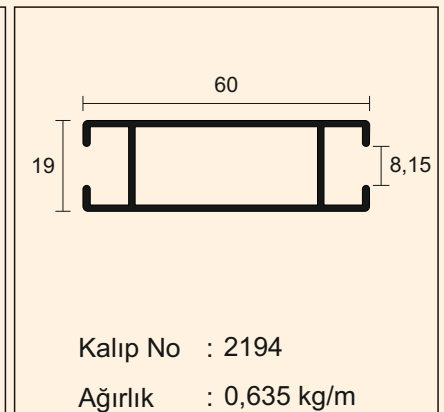
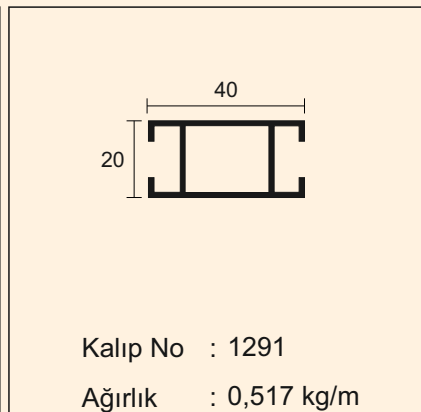
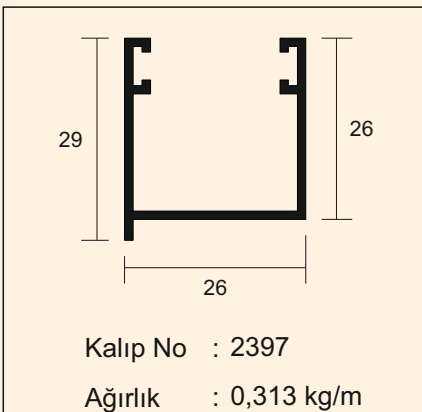
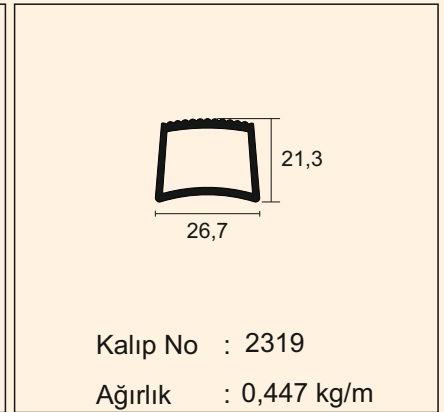
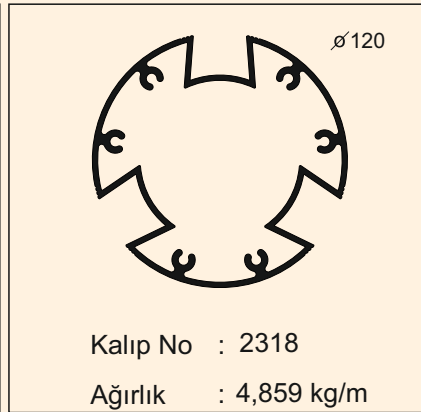
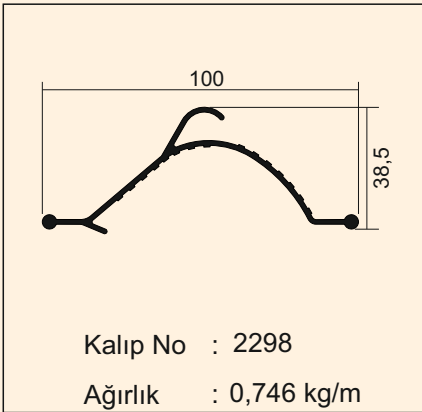
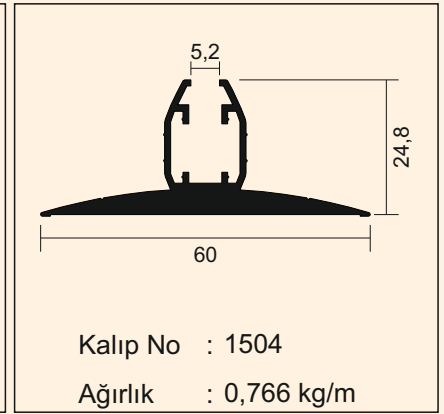
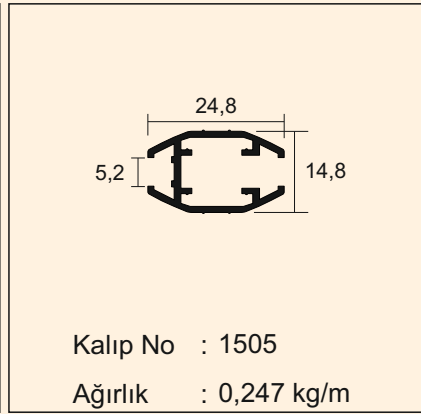
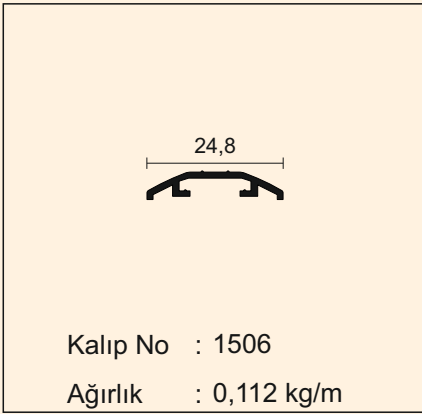
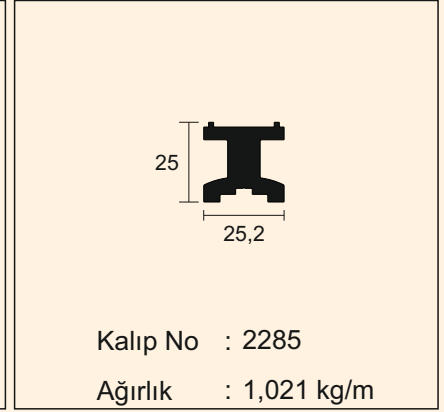
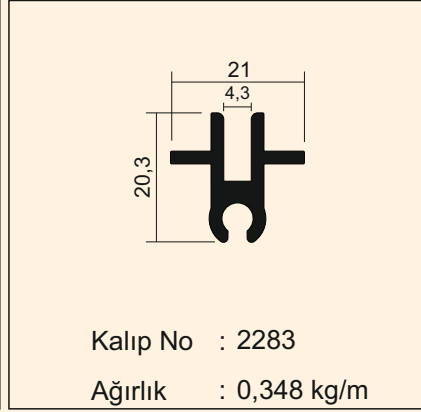
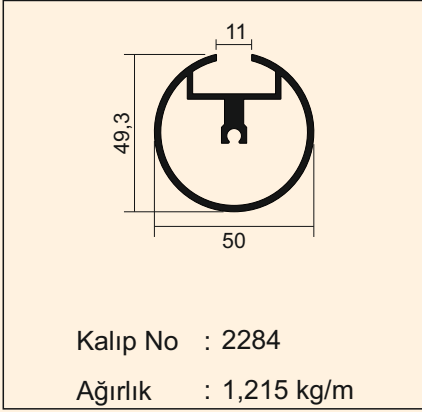

Kataloğumuzda bulunan profil çizimleri örnek olarak konulmuştur. Müşterilerimize ait olan çizimlerin profilleri satılamaz. Çizimler üzerinden ölçü almayınız. Resimlerin altında yer alan profil ağırlığı bilgi amaçlı olup, ürünlerin teslim anındaki tartımız ağırlığı geçerlidir.

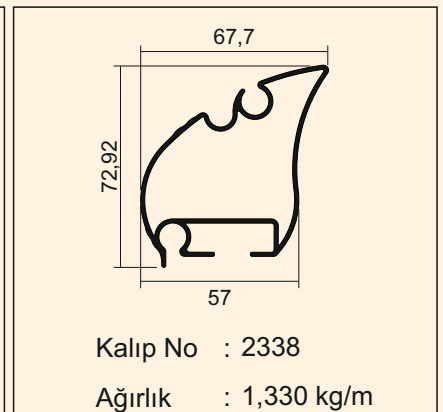
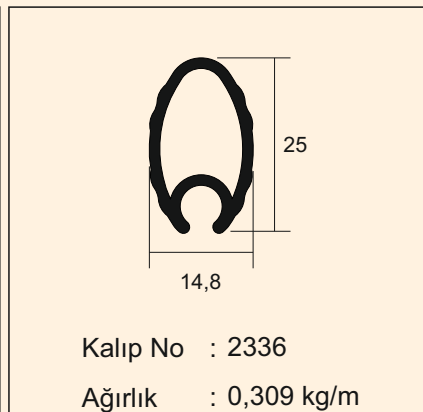
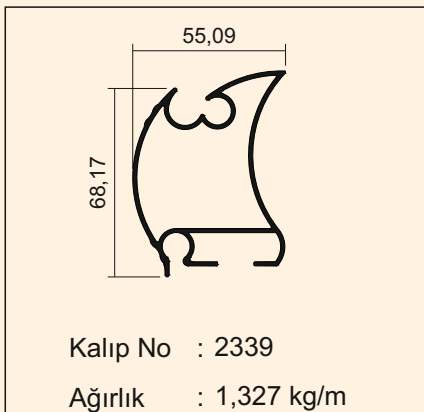
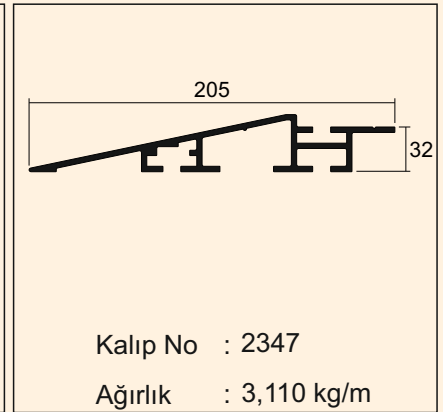
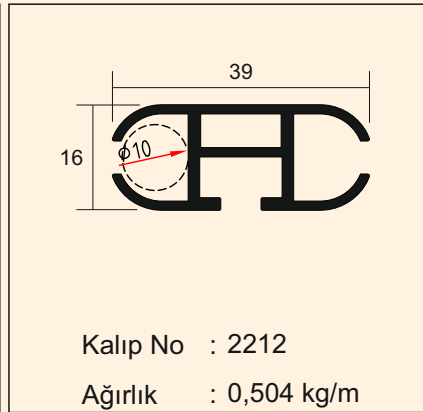
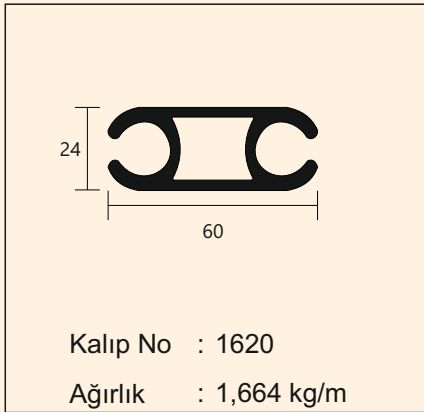
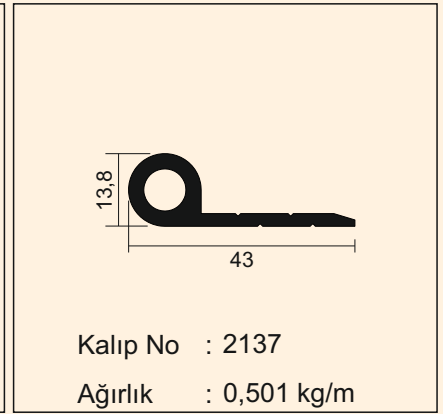
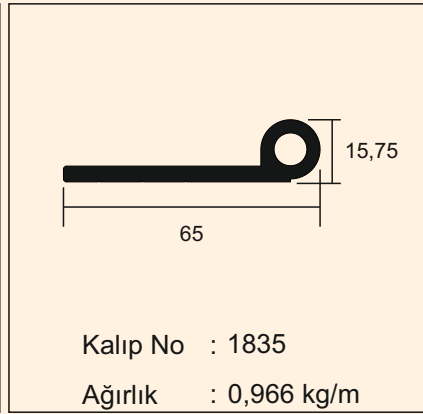
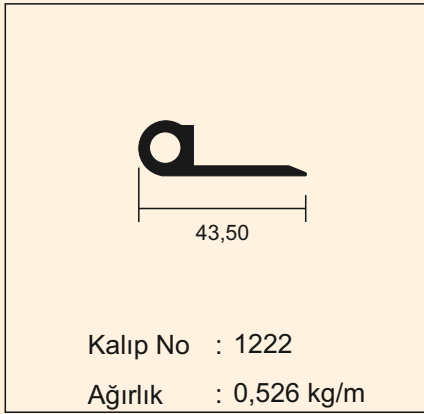
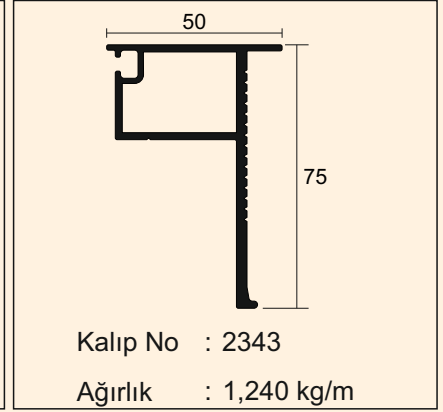
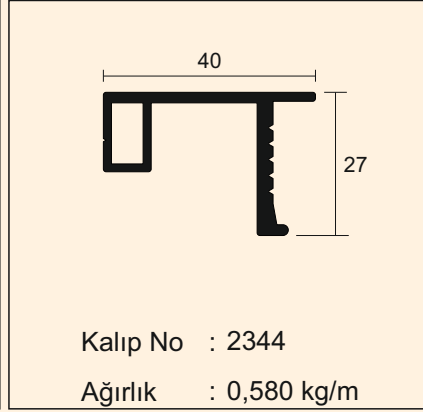
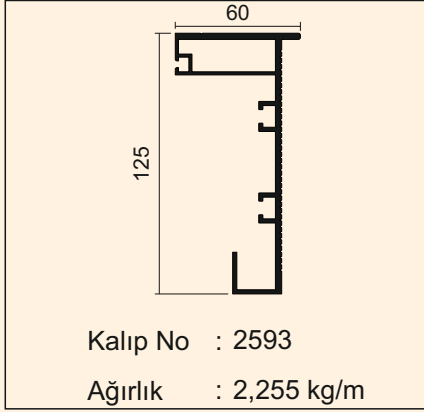

Katalogumuzda bulunan profil çizimleri örnek olarak konulmuştur. Müşterilerimize ait olan çizimlerin profilleri satılamaz. Çizimler üzerinden ölçü almayınız. Resimlerin altında yer alan profil ağırlığı bilgi amaçlı olup, ürünlerin teslim anındaki tartımız ağırlığı geçerlidir.

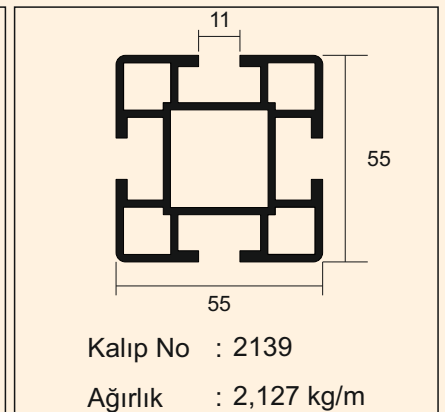
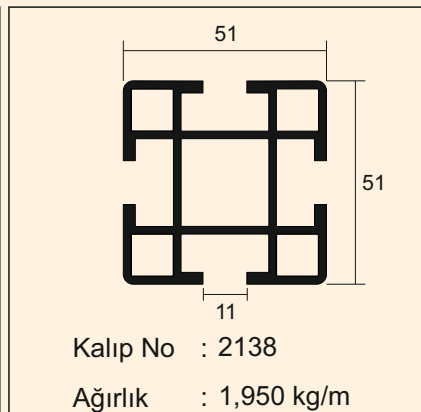
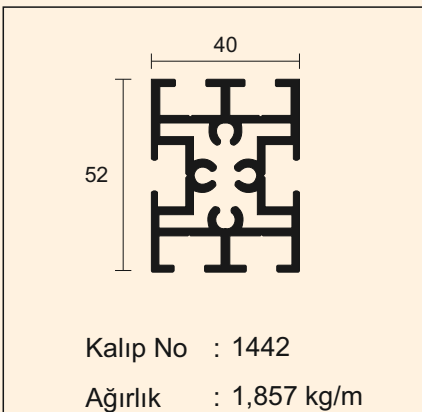
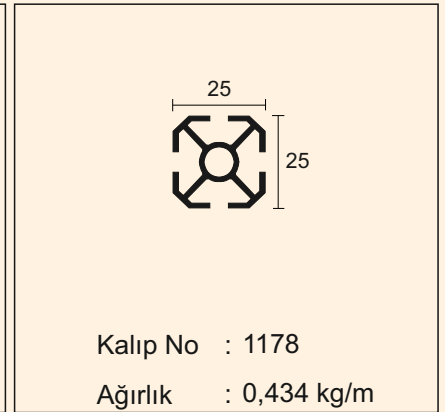
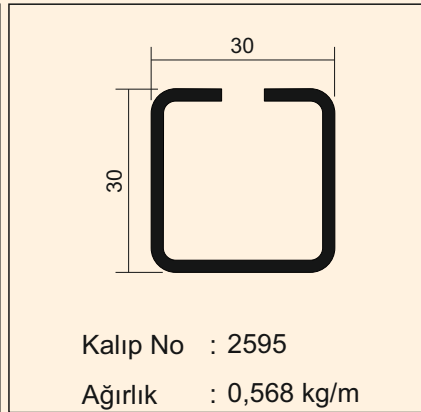
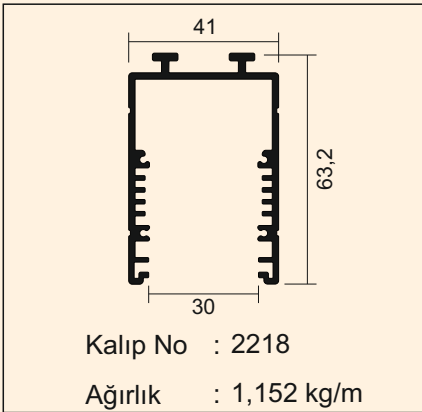
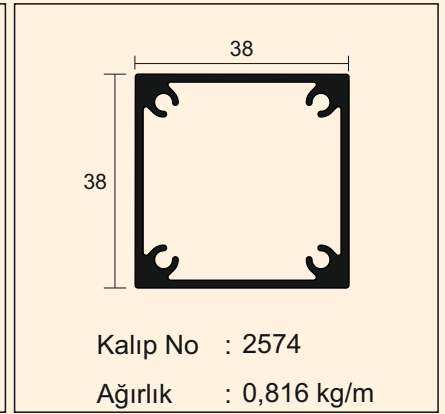
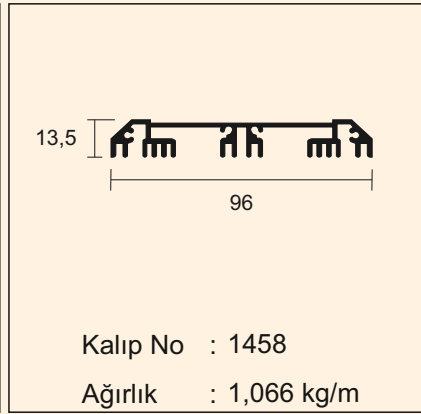
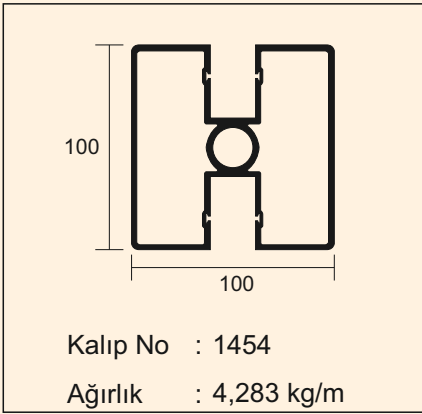
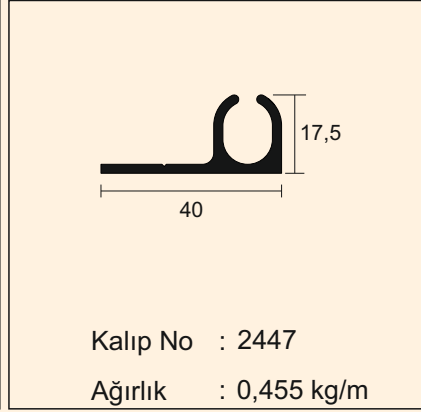
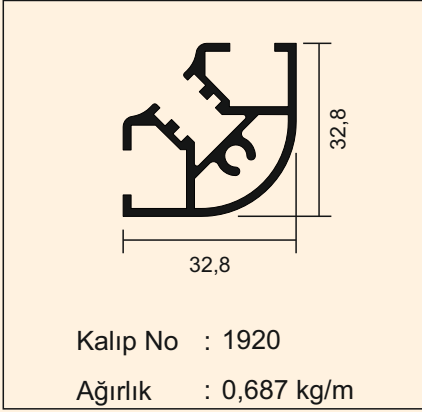

Kalıp No : 2367
Ağırlık : 0,370 kg/m

Kalıp No : 2368
Ağırlık : 0,575 kg/m

Kalıp No : 2369
Ağırlık : 0,821 kg/m

Kalıp No : 2370
Ağırlık : 1,037 kg/m

Kalıp No : 2371
Ağırlık : 1,193 kg/m

Kalıp No : 2362
Ağırlık : 1,633 kg/m

Kalıp No : 2372
Ağırlık : 1,703 kg/m

Kalıp No : 2373
Ağırlık : 1,572 kg/m

Kalıp No : 2374
Ağırlık : 2,521 kg/m

Kalıp No : 2375
Ağırlık : 2,510 kg/m

Kalıp No : 2376
Ağırlık : 2,214 kg/m

Kalıp No : 2377
Ağırlık : 2,667 kg/m

Kataloğumuzda bulunan profil çizimleri örnek olarak konulmuştur. Müşterilerimize ait olan çizimlerin profilleri satılamaz. Çizimler üzerinden ölçü almayınız. Resimlerin altında yer alan profil ağırlığı bilgi amaçlı olup, ürünlerin teslim anındaki tartımız ağırlığı geçerlidir.

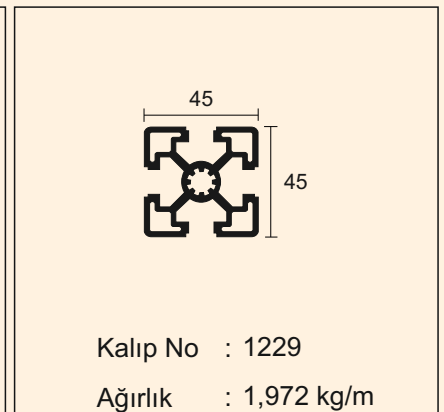
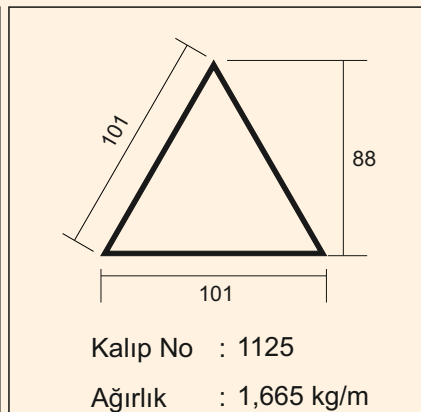
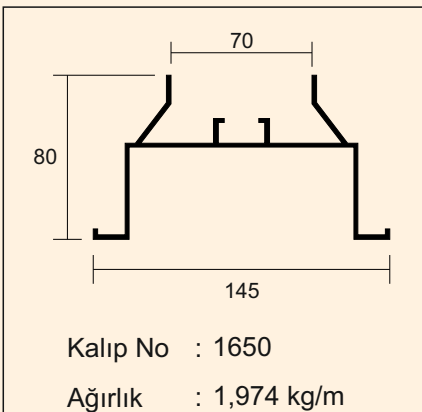
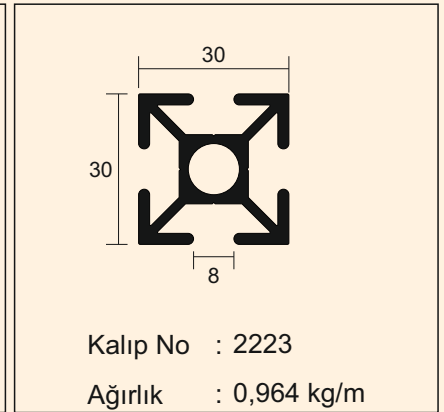
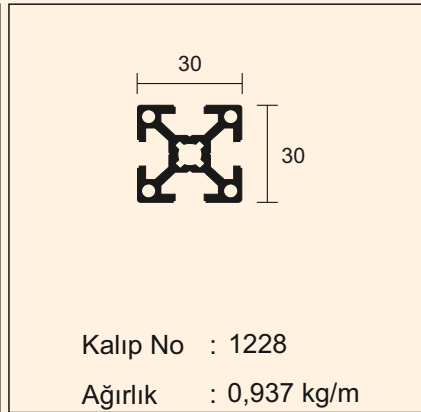
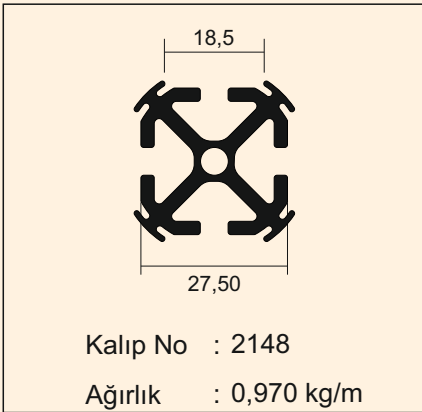
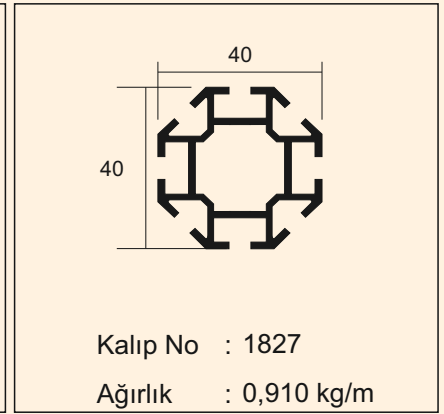
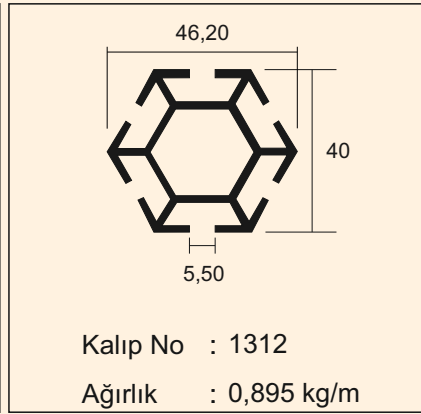
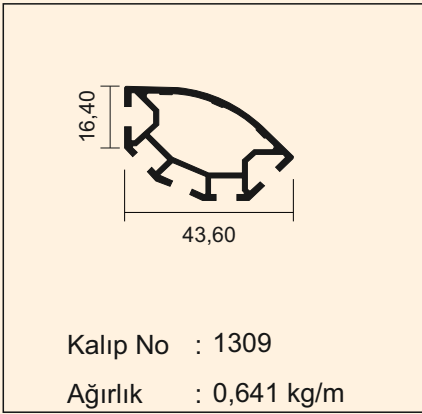
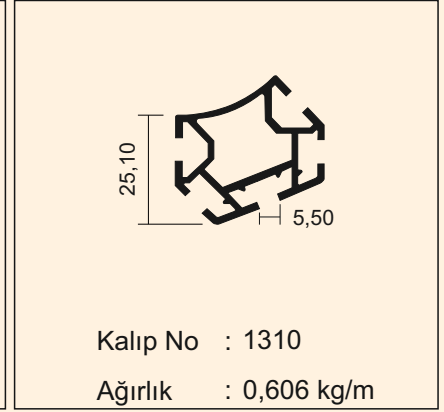
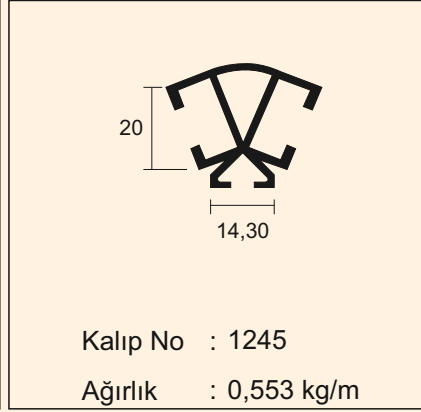
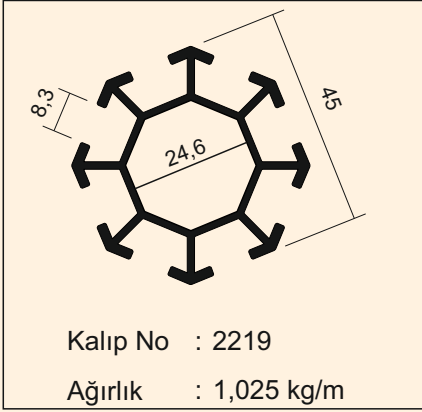

Katalogumuzda bulunan profil çizimleri örnek olarak konulmuştur. Müşterilerimize ait olan çizimlerin profilleri satılamaz. Çizimler üzerinden ölçü almayınız. Resimlerin altında yer alan profil ağırlığı bilgi amaçlı olup, ürünlerin teslim anındaki tartımız ağırlığı geçerlidir.

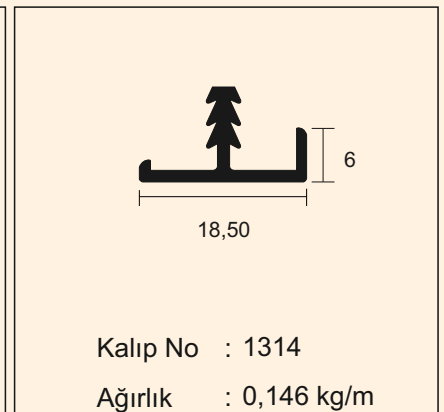
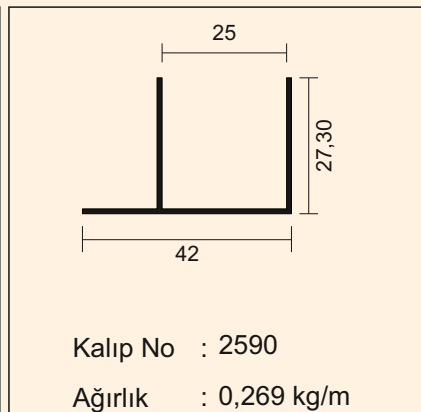
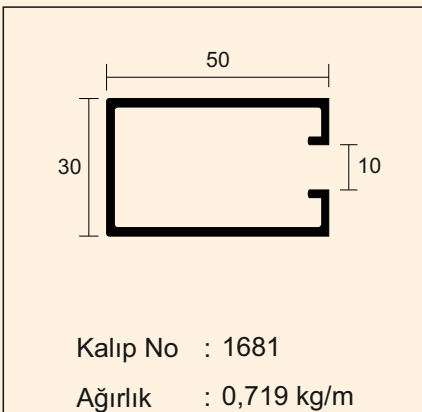
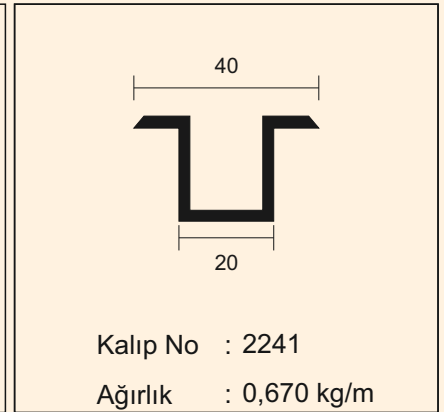
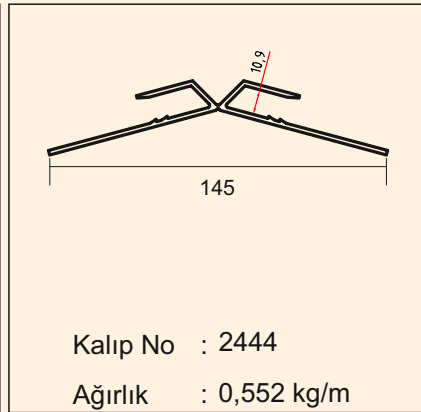
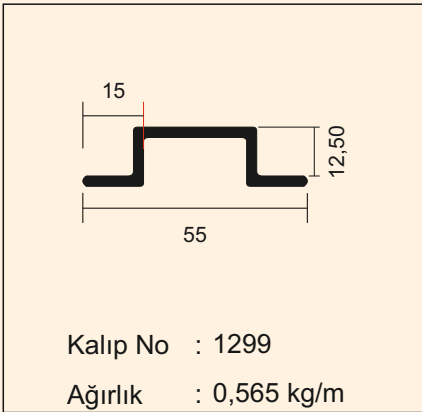
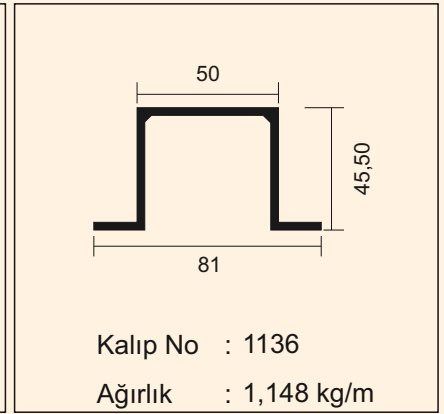
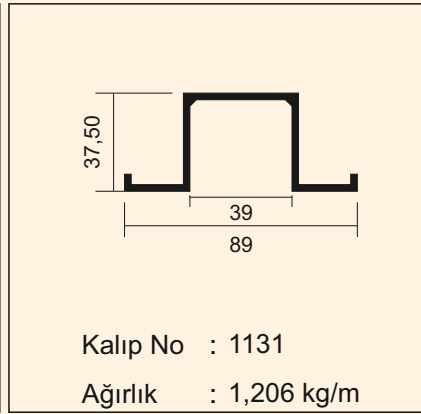
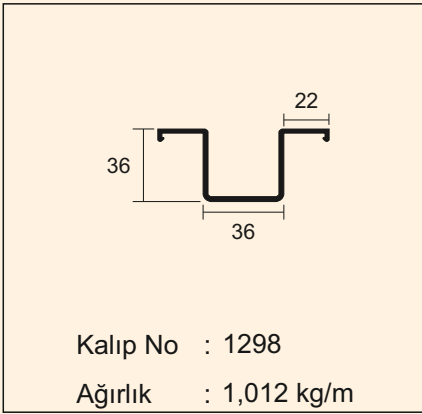
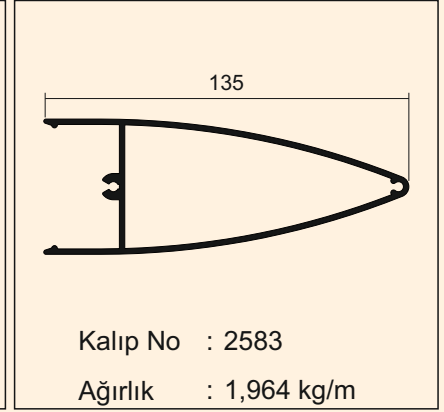
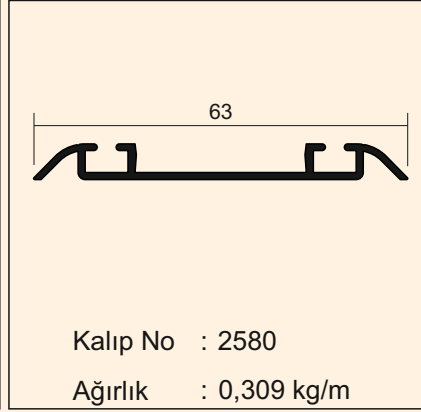
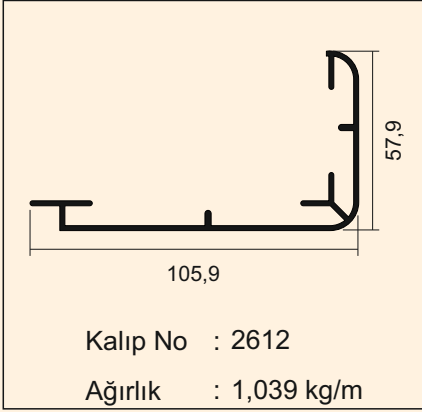

Kataloğumuzda bulunan profil çizimleri örnek olarak konulmuştur. Müşterilerimize ait olan çizimlerin profilleri satılamaz. Çizimler üzerinden ölçü almayınız. Resimlerin altında yer alan profil ağırlığı bilgi amaçlı olup, ürünlerin teslim anındaki tartımız ağırlığı geçerlidir.

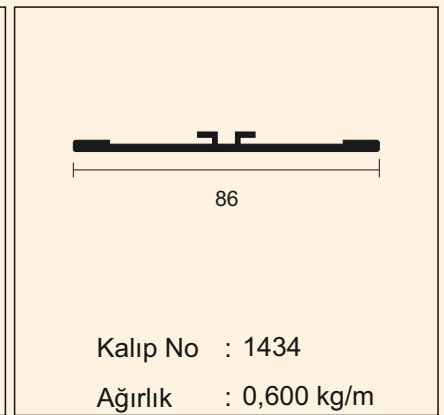
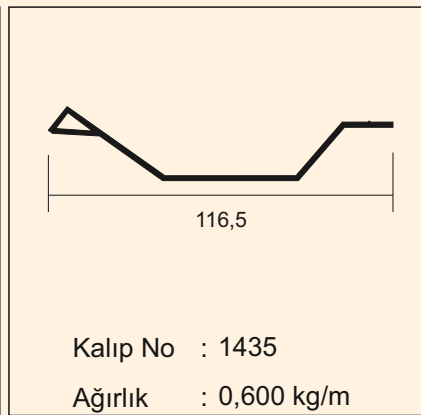
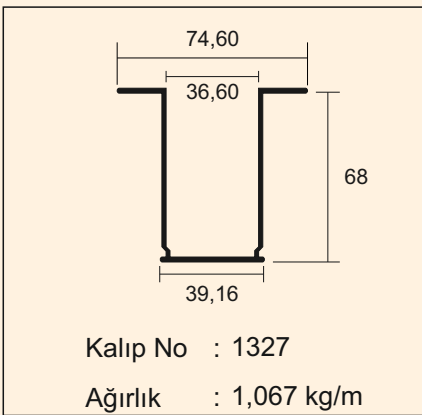
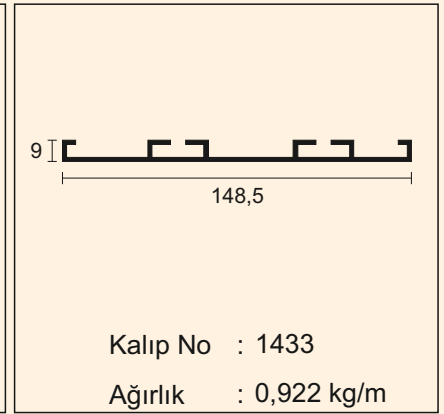
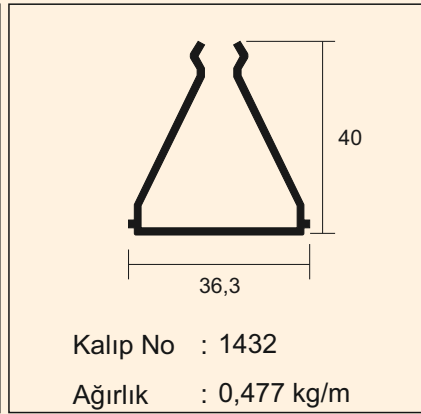
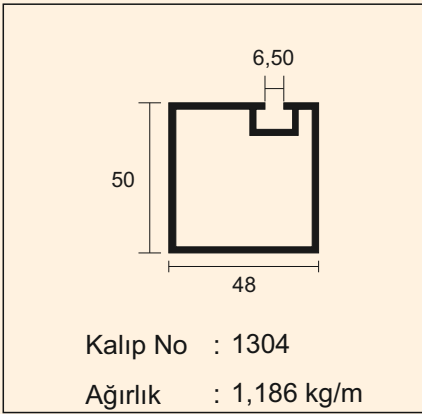
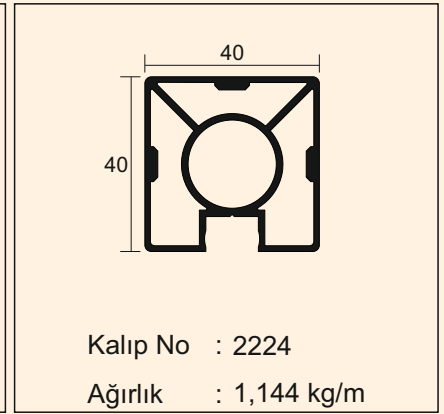
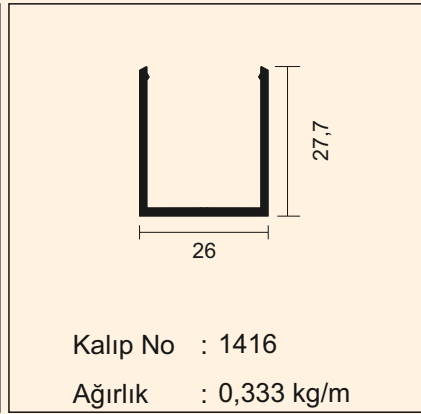
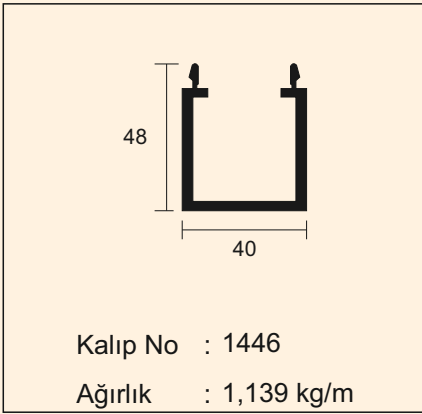
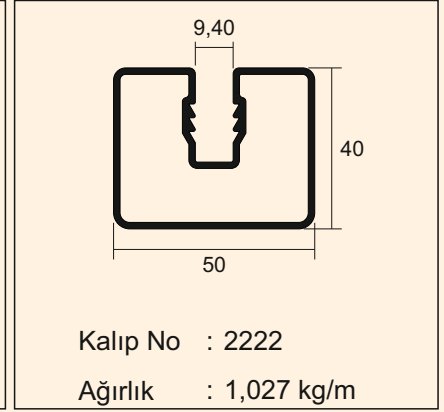
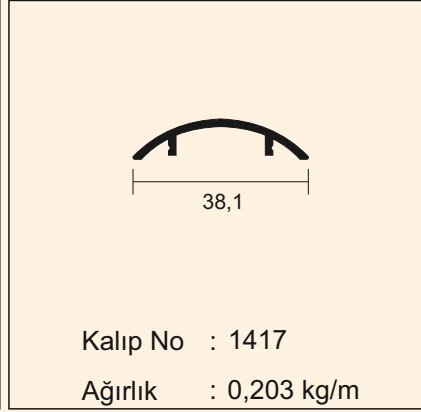
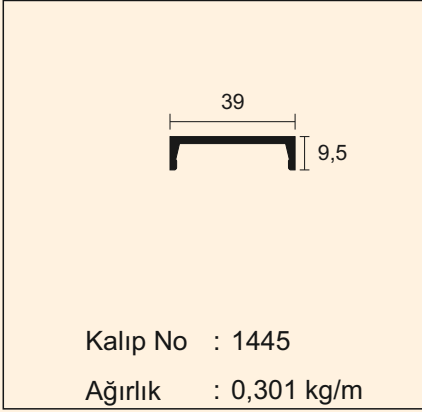

Kataloğumuzda bulunan profil çizimleri örnek olarak konulmuştur. Müşterilerimize ait olan çizimlerin profilleri satılamaz. Çizimler üzerinden ölçü almayınız. Resimlerin altında yer alan profil ağırlığı bilgi amaçlı olup, ürünlerin teslim anındaki tartımız ağırlığı geçerlidir.

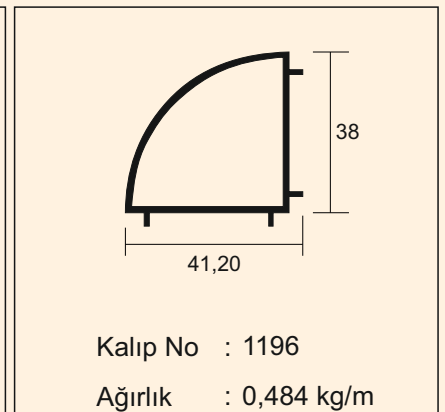
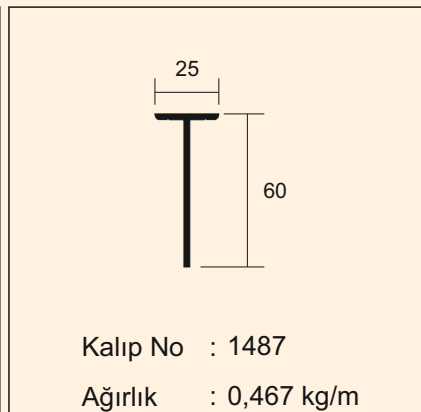
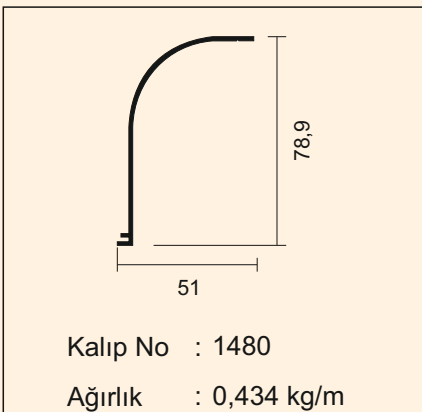
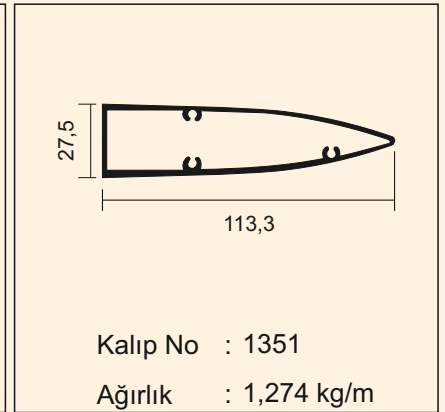
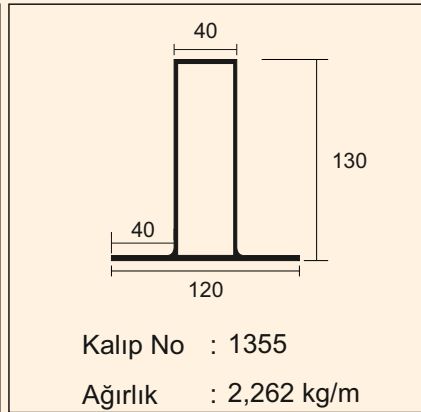
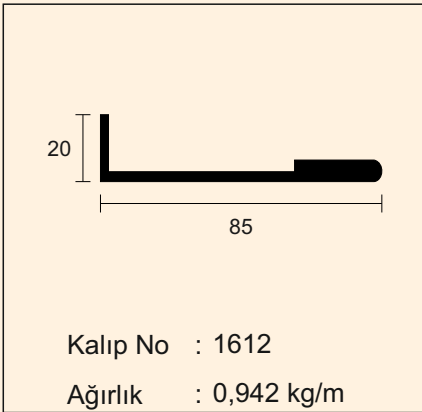
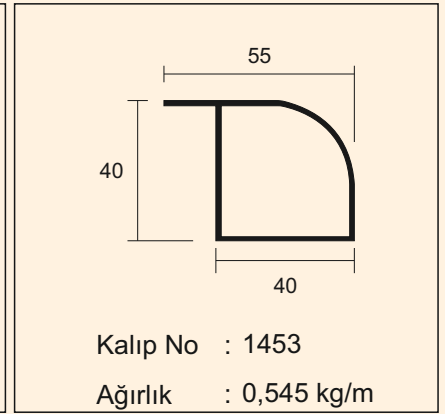
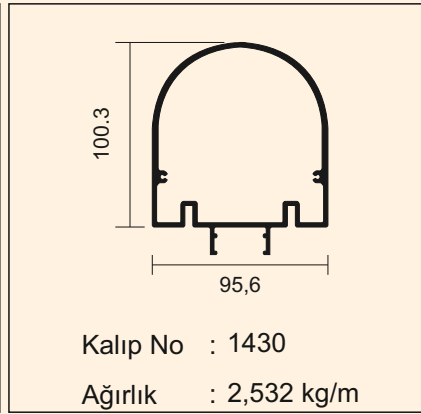
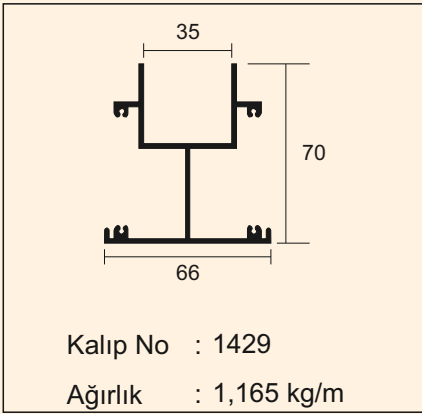
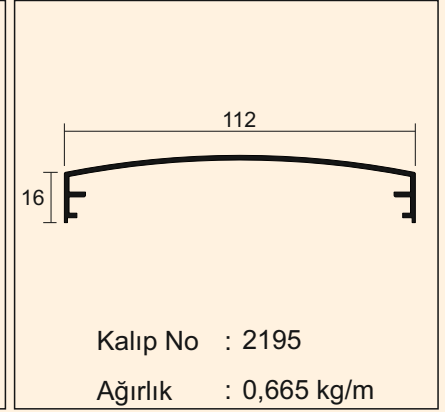
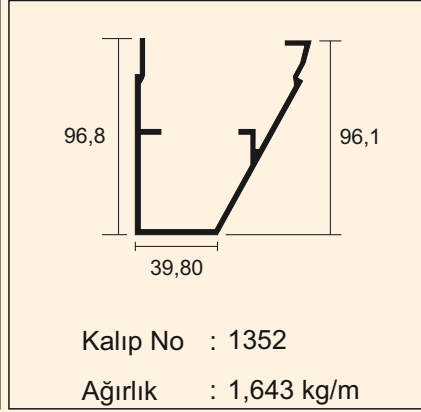
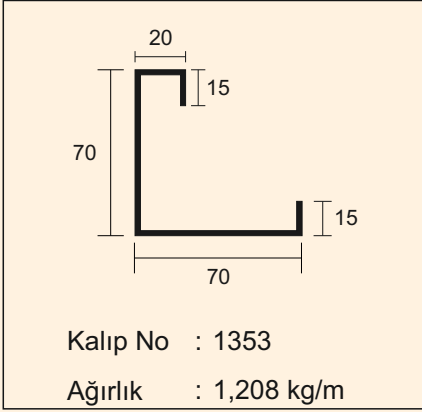

Katalogumuzda bulunan profil çizimleri örnek olarak konulmuştur. Müşterilerimize ait olan çizimlerin profilleri satılamaz. Çizimler üzerinden ölçü almayınız. Resimlerin altında yer alan profil ağırlığı bilgi amaçlı olup, ürünlerin teslim anındaki tartımız ağırlığı geçerlidir.

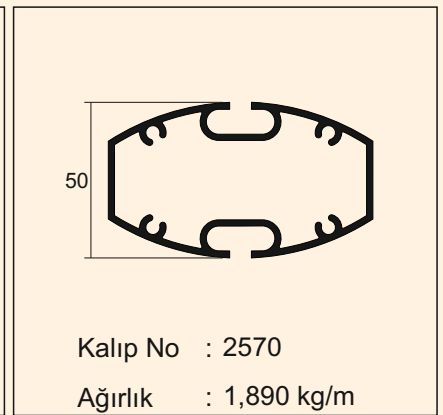
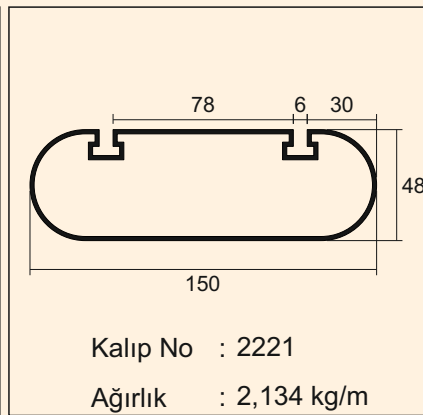
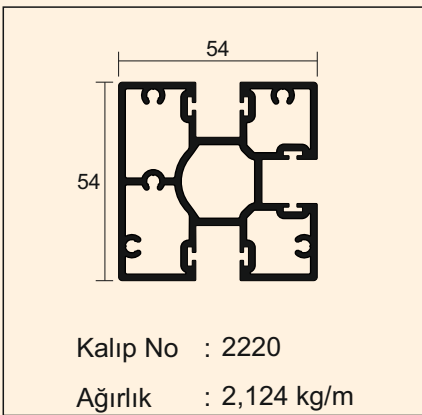
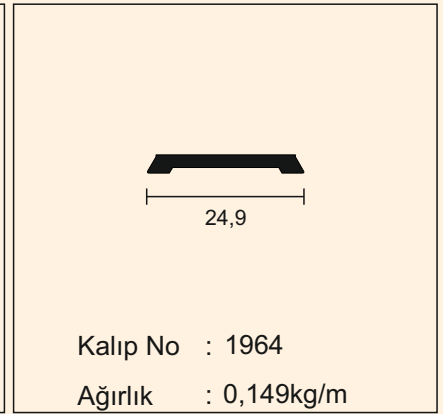
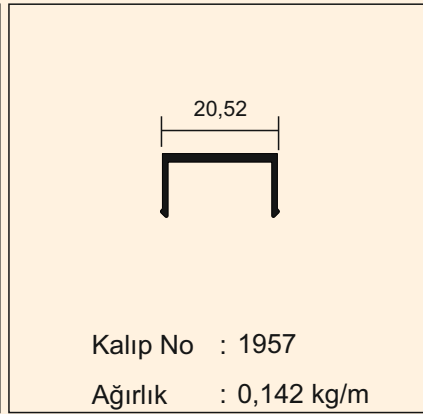
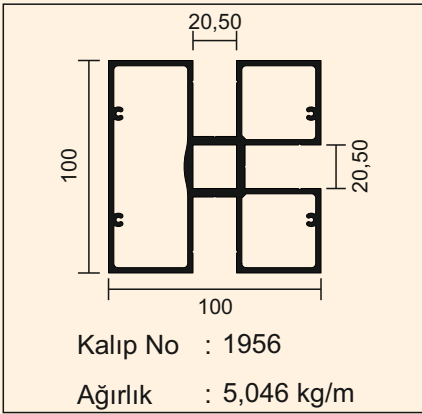
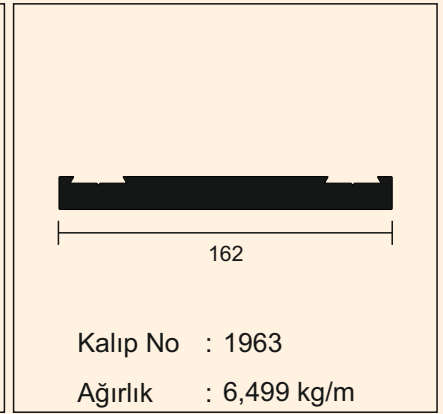
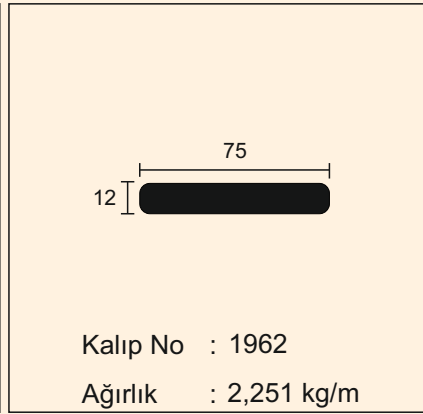
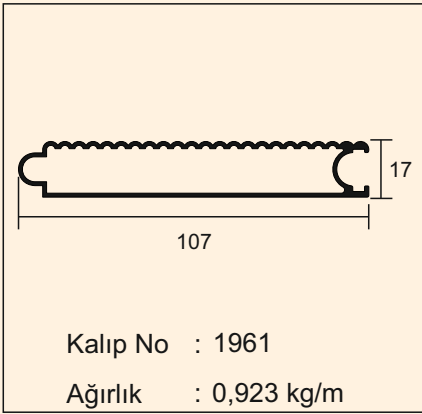
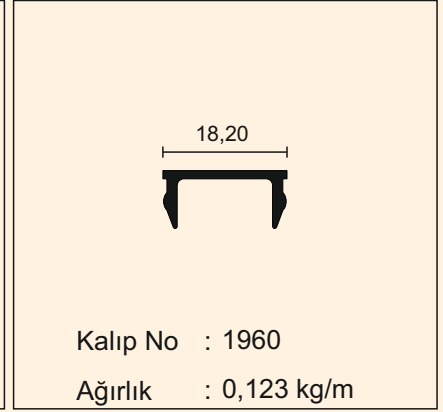
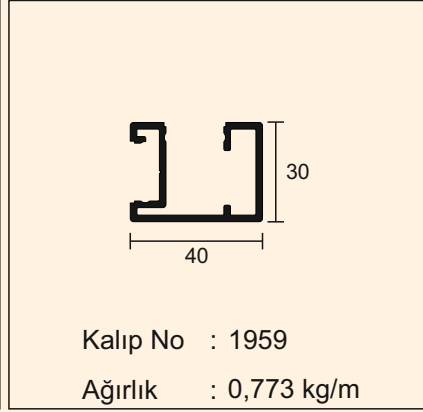
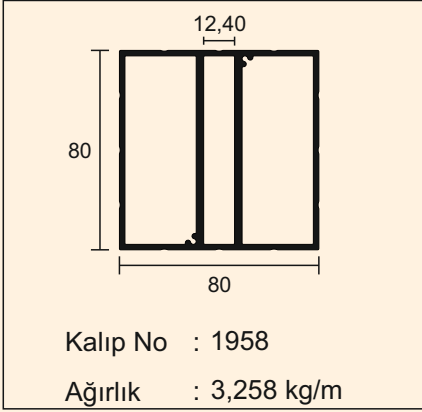

Katalogumuzda bulunan profil çizimleri örnek olarak konulmuştur. Müşterilerimize ait olan çizimlerin profilleri satılamaz. Çizimler üzerinden ölçü almayınız. Resimlerin altında yer alan profil ağırlığı bilgi amaçlı olup, ürünlerin teslim anındaki tartımız ağırlığı geçerlidir.

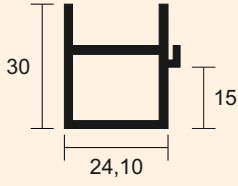

Kalıp No : 1293
Ağırlık : 0,546 kg/m

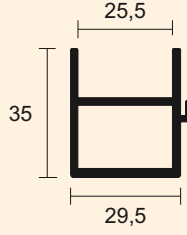

Kalıp No : 1399
Ağırlık : 0,718 kg/m

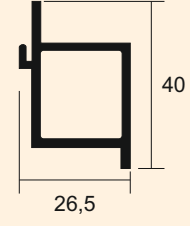

Kalıp No : 1472
Ağırlık : 0,620 kg/m

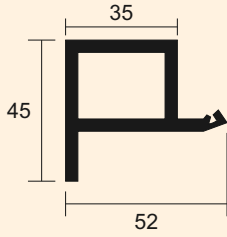

Kalıp No : 1037
Ağırlık : 1,278 kg/m

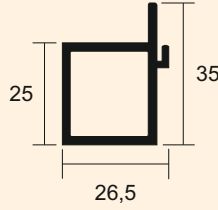

Kalıp No : 1470
Ağırlık : 0,591 kg/m

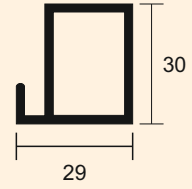

Kalıp No : 1471
Ağırlık : 0,628 kg/m

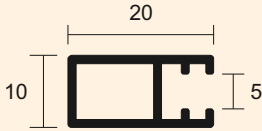

Kalıp No : 1463
Ağırlık : 0,191 kg/m

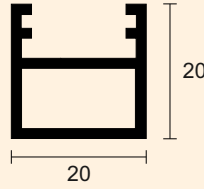

Kalıp No : 1619
Ağırlık : 0,298 kg/m

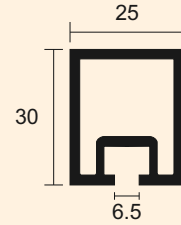

Kalıp No : 1186
Ağırlık : 0,676 kg/m

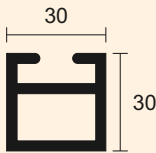

Kalıp No : 1034
Ağırlık : 1,036 kg/m

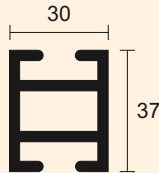

Kalıp No : 1033
Ağırlık : 1,269 kg/m

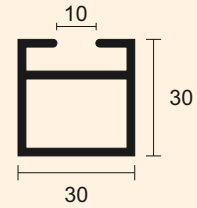

Kalıp No : 1114
Ağırlık : 0,726 kg/m

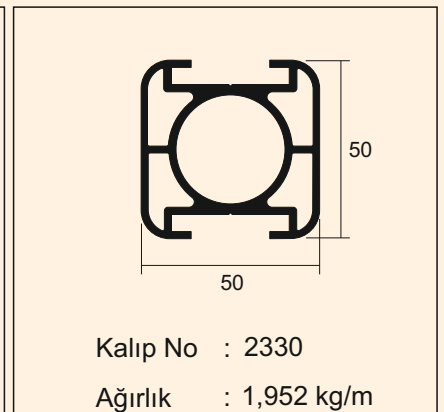
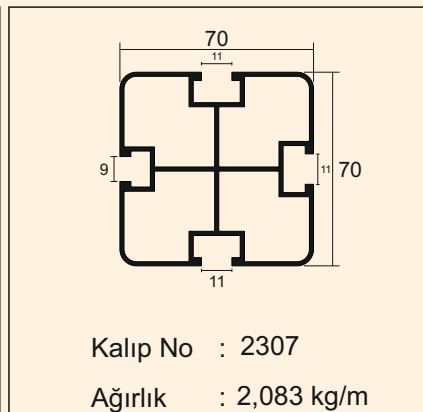
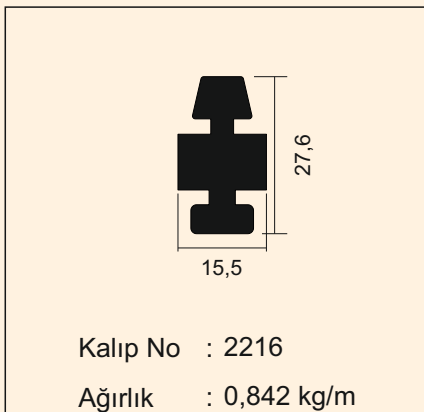
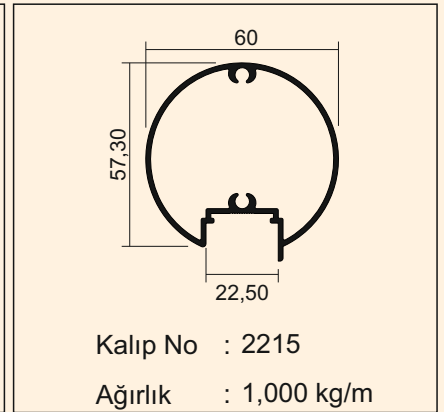
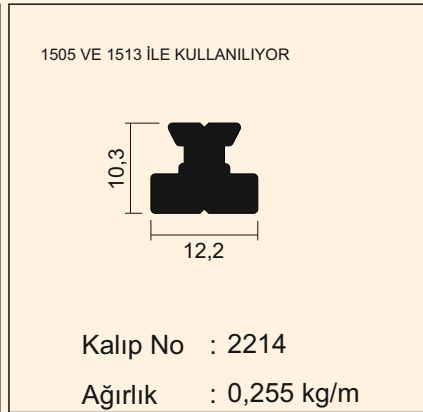
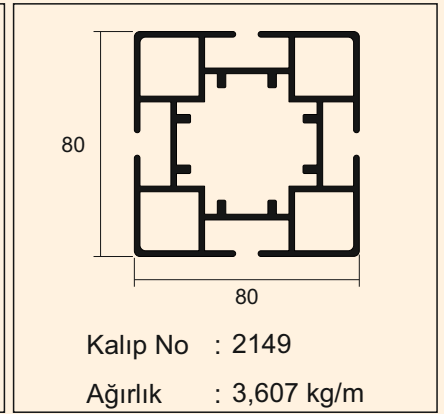
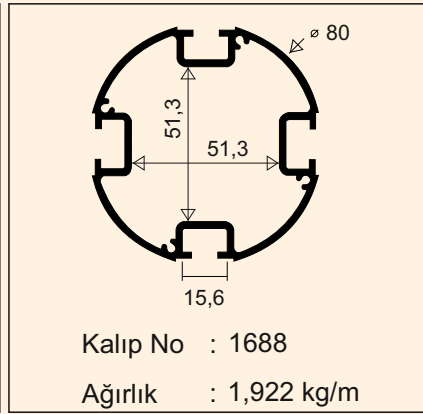
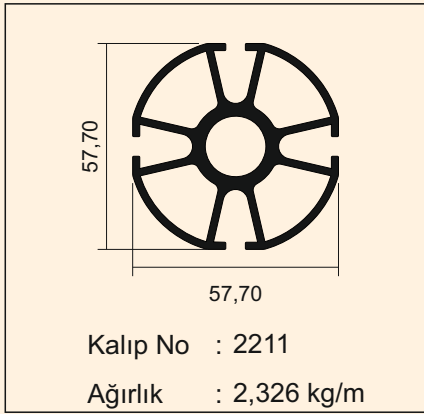
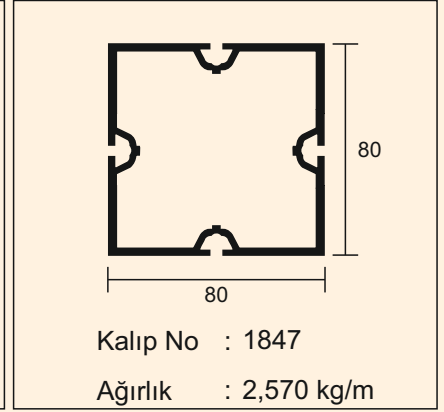
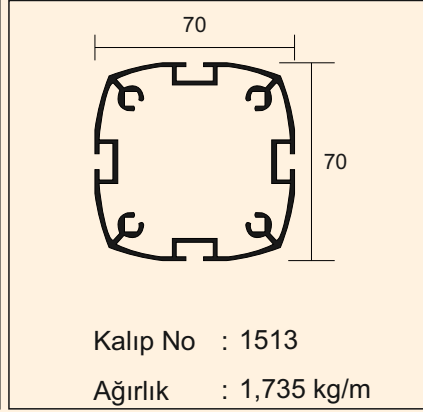
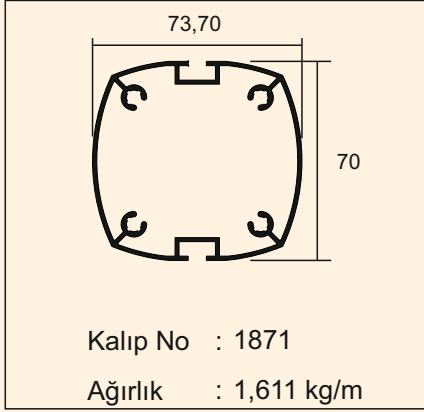

Kataloğumuzda bulunan profil çizimleri örnek olarak konulmuştur. Müşterilerimize ait olan çizimlerin profilleri satılamaz. Çizimler üzerinden ölçü almayınız. Resimlerin altında yer alan profil ağırlığı bilgi amaçlı olup, ürünlerin teslim anındaki tartımız ağırlığı geçerlidir.

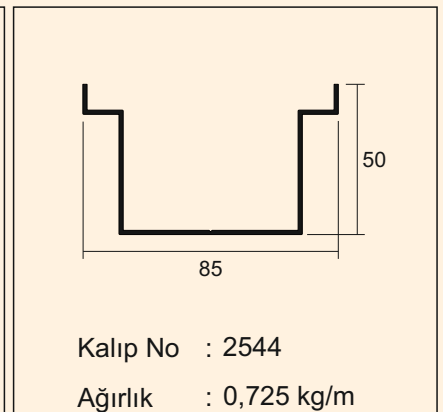
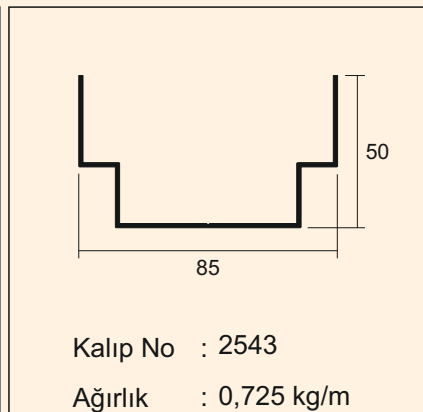
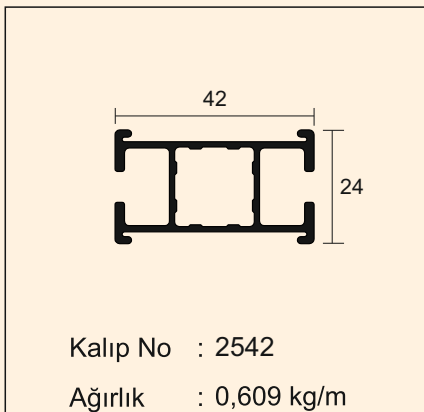
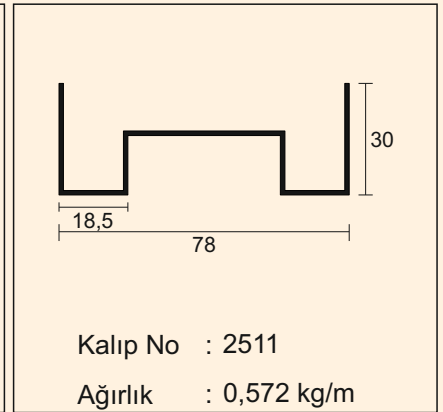
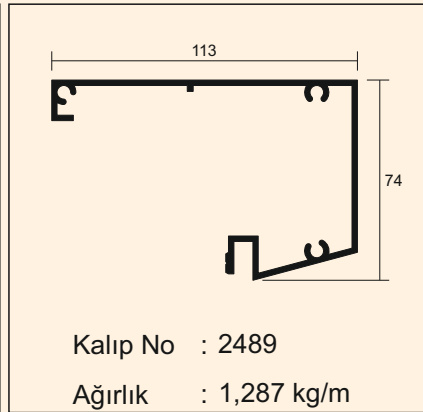
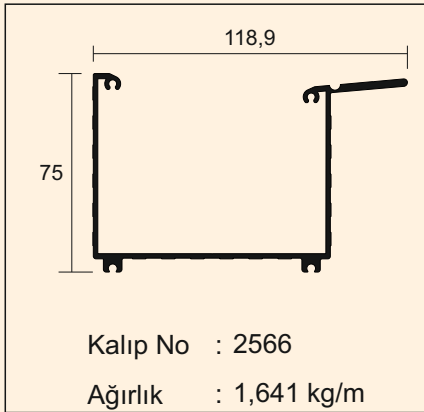
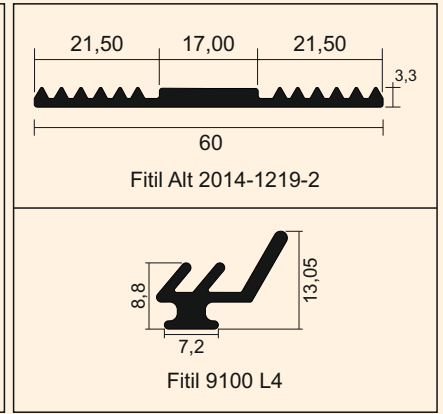
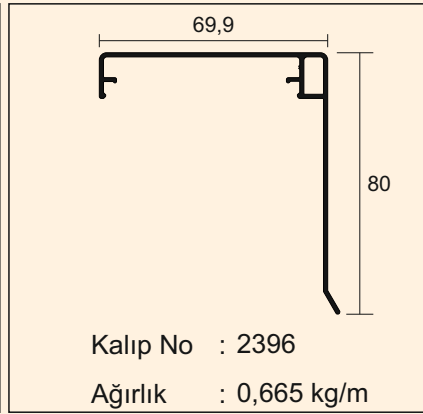
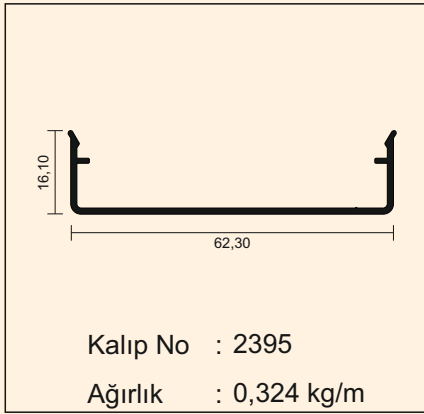
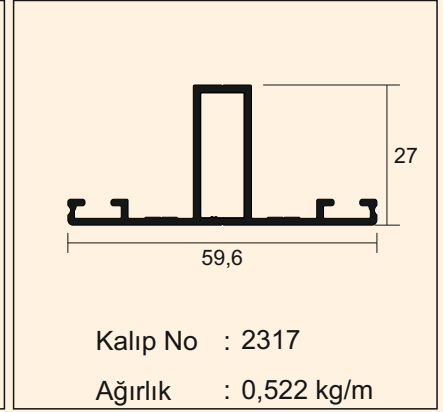
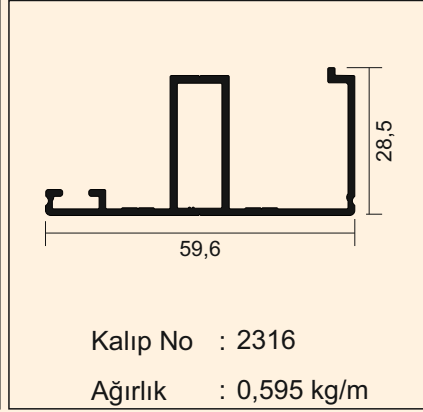
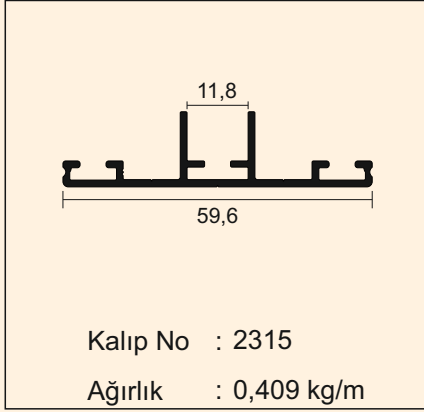

Katalogumuzda bulunan profil çizimleri örnek olarak konulmuştur. Müşterilerimize ait olan çizimlerin profilleri satılamaz. Çizimler üzerinden ölçü almayınız. Resimlerin altında yer alan profil ağırlığı bilgi amaçlı olup, ürünlerin teslim anındaki tartımız ağırlığı geçerlidir.