

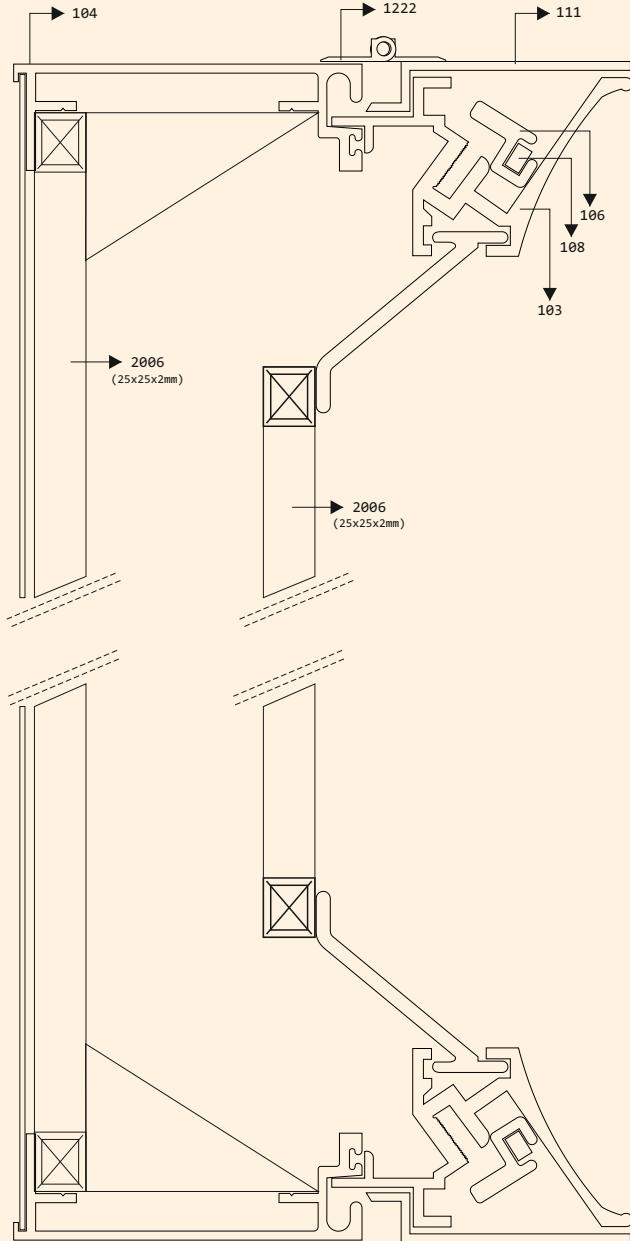

**MEF Metal ve Reklam Ürünleri  
San.Tic. A.Ş.**

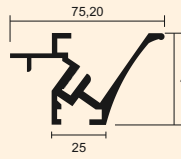
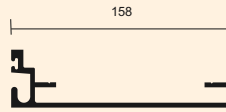
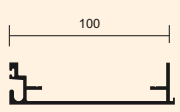
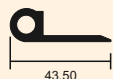
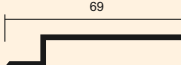
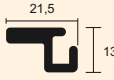

 <p>Kalıp No : 103 Ağırlık : 1,545 kg/m</p>	 <p>Kalıp No : 104 Ağırlık : 1,445 kg/m</p>	 <p>Kalıp No : 110 Ağırlık : 1,103 kg/m</p>	 <p>Kalıp No : 1222 Ağırlık : 0,526 kg/m</p>
---	--	--	---

 <p>Kalıp No : 111 Ağırlık : 0,450 kg/m</p>	 <p>Kalıp No : 106 Ağırlık : 0,346 kg/m</p>	 <p>Kalıp No : 108 Ağırlık : 0,050 kg/m</p>	 <p>Kalıp No : 100 Ağırlık : 2,176 kg/m</p>
---	--	--	--



500 x 100 cm EBADINDA TEK TARAFLI IŞIKLI KASA					
Sıra No	Kalıp No	Kullanım Yeri	Miktar (m)	Ağırlık (kg/m)	Toplam Ağırlık (kg)
1	103	Üst Vinil Germe Kasa	12	1,545	18,540
2	204	Alt Kasa	12	1,445	17,340
3	111	Kapak	12	0,450	5,400
4	100	Takviye Profili	1	2,176	2,176
5	106	Klips	6	0,346	2,076
6	108	Klips Çubuğu	12	0,050	0,600
7	2006	25x25 Kutu Profil	12	0,523	6,276
8	Genel Toplam Ağırlık				52,408
9	m <sup>2</sup> 'ye Düşen Ağırlık				10,482

Alt kasa olarak kalıp no 110 kullanılabilir

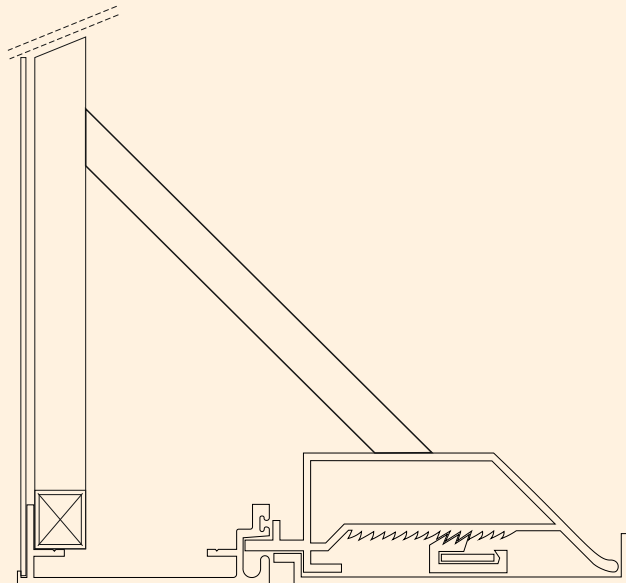
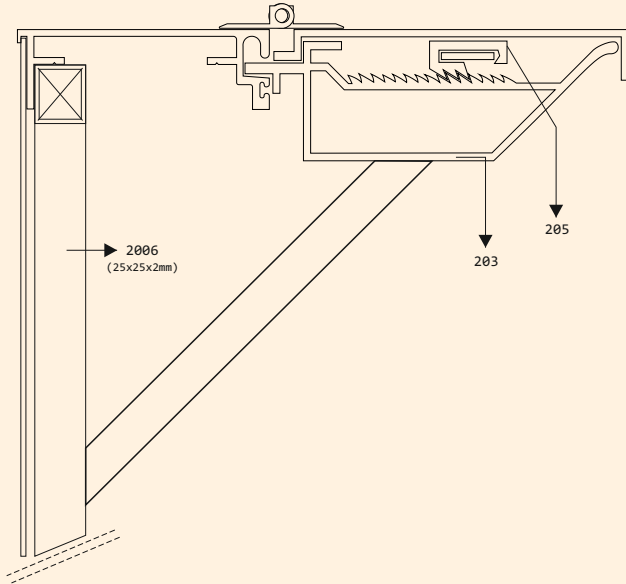
Menteşe olarak yaprak menteşe veya kalıp no 1222 kullanılabilir

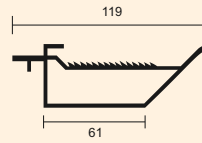
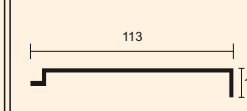
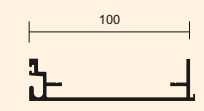

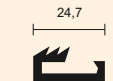
 <p>Kalıp No : 203 Ağırlık : 1,808 kg/m</p>	 <p>Kalıp No : 204 Ağırlık : 0,755 kg/m</p>	 <p><small>Ortak Alt Profil / 202 Sistem</small> Kalıp No : 110 Ağırlık : 1,103 kg/m</p>
--	--	---

 <p>Kalıp No : 205 Ağırlık : 0,360 kg/m</p>	 <p>Kalıp No : 1222 Ağırlık : 0,526 kg/m</p>
--	---

**500 x 100 cm EBADINDA TEK TARAFLI IŞIKLI KASA**

Sıra No	Kalıp No	Kullanım Yeri	Miktar (m)	Ağırlık (kg/m)	Toplam Ağırlık (kg)
1	203	Üst Vinil Germe Kasa	12	1,808	21,696
2	110	Alt Kasa	12	1,103	13,236
3	204	Kapak	12	0,755	9,060
4	205	Klips	6	0,360	2,160
5	2006	25x25 Kutu Profil	12	0,523	6,276
6	Genel Toplam Ağırlık				52,428
7	m <sup>2</sup> 'ye Düşen Ağırlık				10,486

Kapak alternatifleri mevcut olup, menteşe hazır menteşedir.

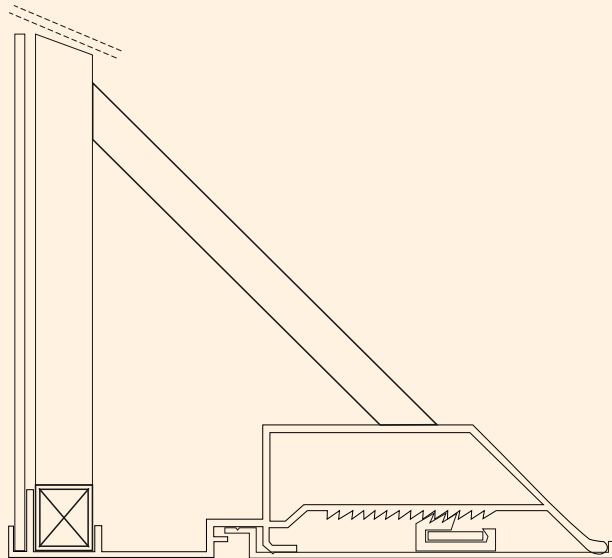
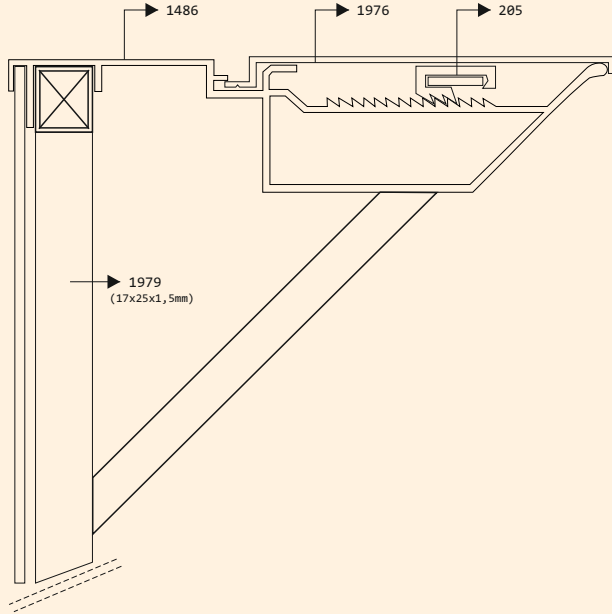

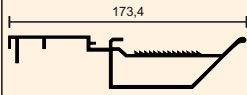
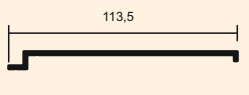
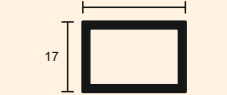
 <p>Kalıp No : 1486 Ağırlık : 1,961 kg/m</p>	 <p>Kalıp No : 1976 Ağırlık : 0,525 kg/m</p>	 <p>Kalıp No : 1979 Ağırlık : 0,333 kg/m</p>
---	---	---



 <p>Kalıp No : 205 Ağırlık : 0,360 kg/m</p>
--

500 x 100 cm EBADINDA TEK TARAFLI IŞIKLI KASA					
Sıra No	Kalıp No	Kullanım Yeri	Miktar (m)	Ağırlık (kg/m)	Toplam Ağırlık (kg)
1	1486	Üst Vinil Germe Kasa	12	1,961	23,532
2	1976	Kapak	12	0,525	6,300
3	205	Klips	6	0,360	2,160
4	1979	17x25 Kutu Profil	12	0,333	3,996
5	Genel Toplam Ağırlık				35,988
6	m <sup>2</sup> 'ye Düşen Ağırlık				7,198

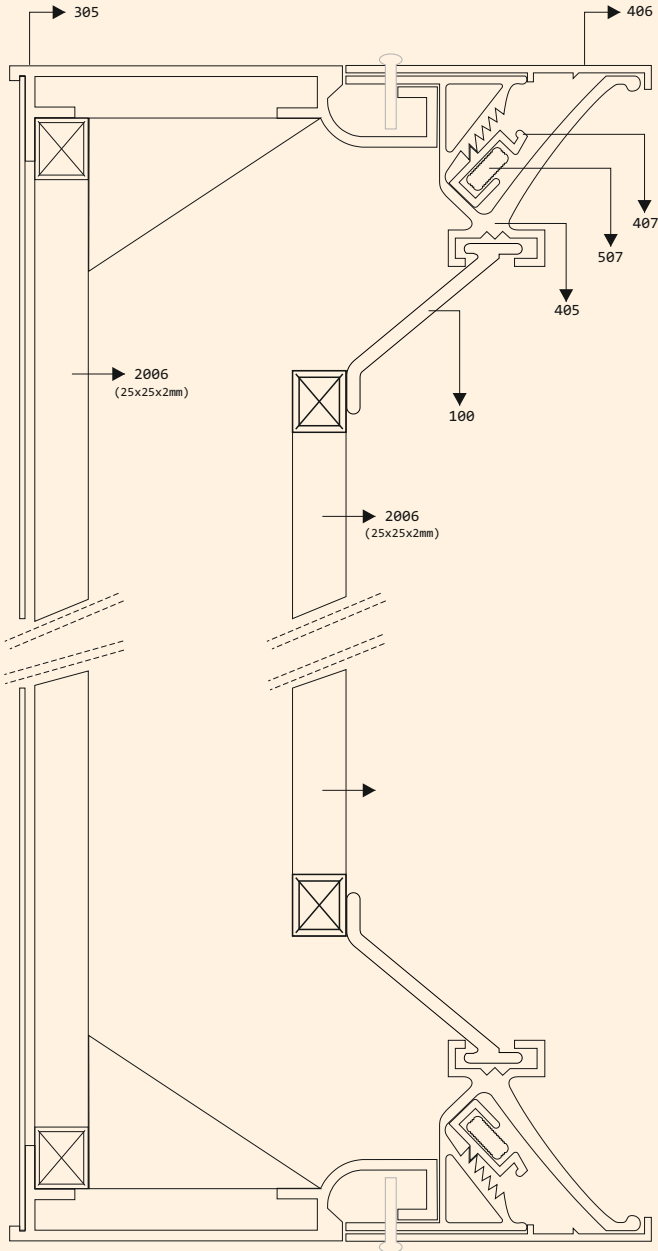
# mef405 vinil kasa

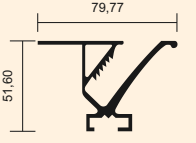
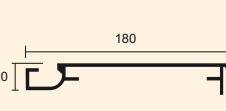
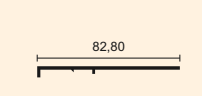
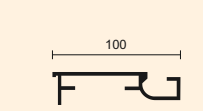
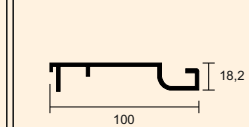

 <p>Kalıp No : 405 Ağırlık : 1,591 kg/m</p>	 <p>Kalıp No : 305 Ağırlık : 1,874 kg/m</p>	 <p>Kalıp No : 406 Ağırlık : 0,405 kg/m</p>	 <p>Kalıp No : 310 Ağırlık : 1,150 kg/m</p>	 <p>Kalıp No : 1484 Ağırlık : 0,938 kg/m</p>
---	--	--	--	---

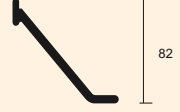
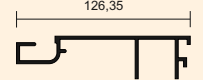
 <p>Kalıp No : 407 Ağırlık : 0,256 kg/m</p>	 <p>Kalıp No : 507 Ağırlık : 0,162 kg/m</p>	 <p>Kalıp No : 100 Ağırlık : 2,176 kg/m</p>	 <p>Kalıp No : 313 Ağırlık : 1,535 kg/m</p>
---	--	--	--

## 500 x 100 cm EBADINDA TEK TARAFLI IŞIKLI KASA

Sıra No	Kalıp No	Kullanım Yeri	Miktar (m)	Ağırlık (kg/m)	Toplam Ağırlık (kg)
1	405	Üst Vinil Germe Kasa	12	1,591	19,092
2	305	Alt Kasa	12	1,874	22,488
3	406	Kapak	12	0,405	4,860
4	100	Takviye Profili	1	2,176	2,176
5	407	Klips	6	0,256	1,536
6	507	Klips Çubuğu	12	0,162	1,944
7	2006	25x25 Kutu Profil	12	0,523	6,276
8	Genel Toplam Ağırlık				58,372
9	m <sup>2</sup> 'ye Düşen Ağırlık				11,674

# mef606 vinil kasa

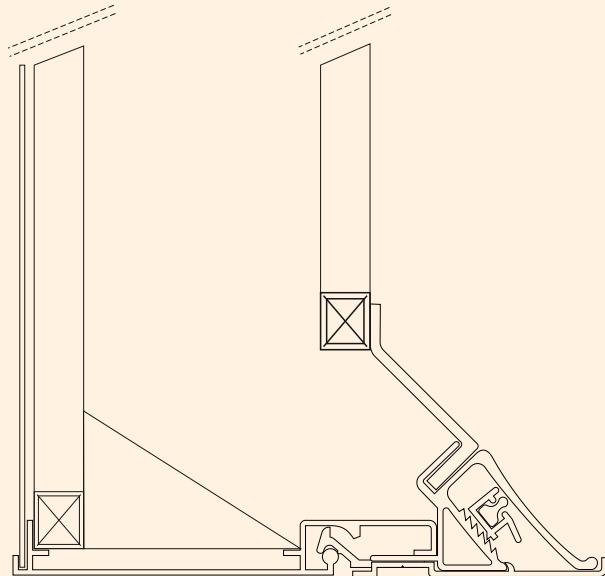
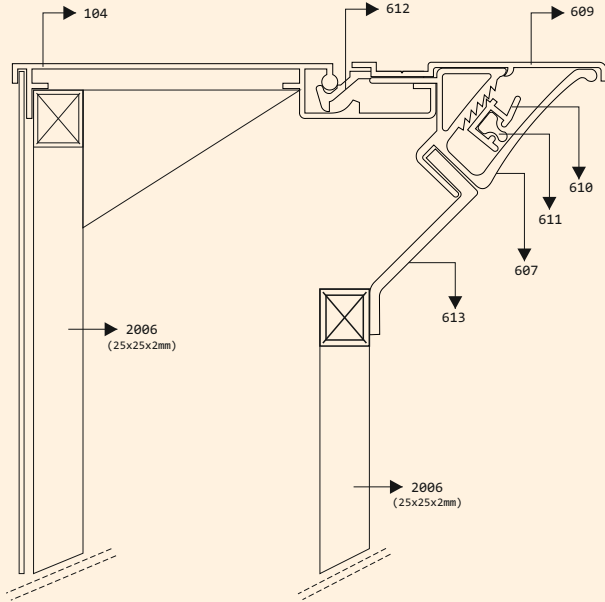

<p>Kalıp No : 607 Ağırlık : 1,296 kg/m</p>	<p>Kalıp No : 608 Ağırlık : 1,261 kg/m</p>	<p>Kalıp No : 609 Ağırlık : 0,520 kg/m</p>
--	--	--

<p>Kalıp No : 610 Ağırlık : 0,212 kg/m</p>	<p>Kalıp No : 611 Ağırlık : 0,084 kg/m</p>	<p>Kalıp No : 613 Ağırlık : 1,834 kg/m</p>
--	--	--

## 500 x 100 cm EBADINDA TEK TARAFLI IŞIKLI KASA

Sıra No	Kalıp No	Kullanım Yeri	Miktar (m)	Ağırlık (kg/m)	Toplam Ağırlık (kg)
1	607	Üst Vinil Germe Kasa	12	1,296	15,552
2	608	Alt Kasa	12	1,251	15,012
3	609	Kapak	12	0,520	6,240
4	613	Takviye Profili	1	1,834	1,834
5	610	Klips	6	0,212	1,272
6	611	Klips Çubuğu	12	0,084	1,008
7	2006	25x25 Kutu Profil	12	0,523	6,276
8	Genel Toplam Ağırlık				47,194
9	m <sup>2</sup> 'ye Düşen Ağırlık				9,439

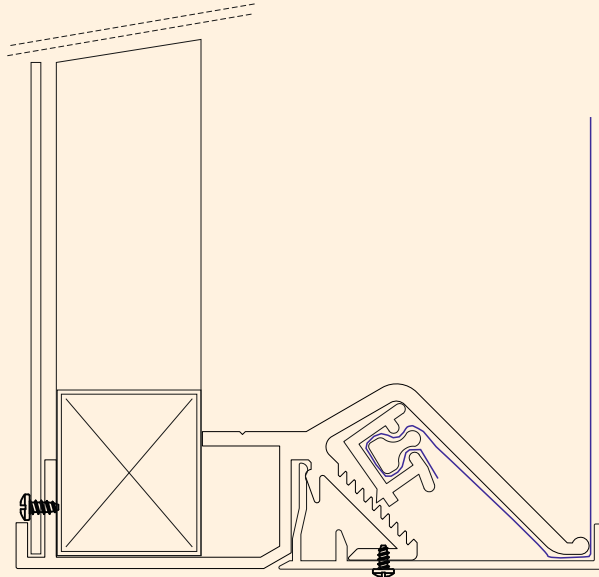
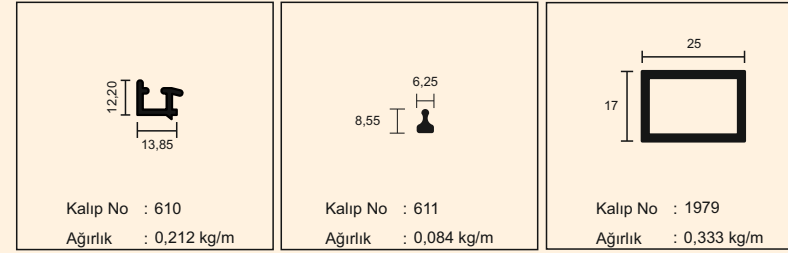
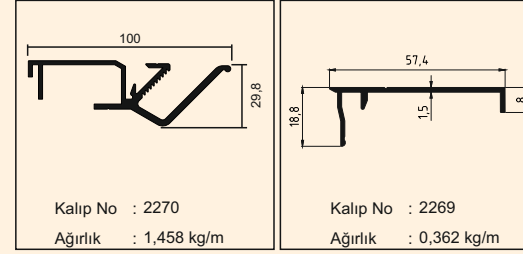
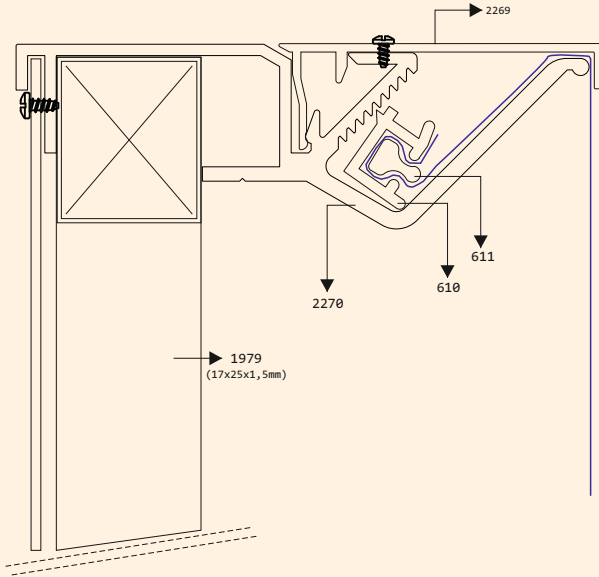

**500 x 100 cm EBADINDA TEK TARAFLI IŞIKLI KASA**

Sıra No	Kalıp No	Kullanım Yeri	Miktar (m)	Ağırlık (kg/m)	Toplam Ağırlık (kg)
1	2270	Üst Vinil Germe Kasa	12	1,458	17,496
2	2269	Kapak	12	0,354	4,248
3	610	Klips	6	0,212	1,272
4	611	Klips Çubuğu	12	0,084	1,008
5	1979	17x25 Kutu Profil	12	0,333	3,996
6	Genel Toplam Ağırlık				28,02
7	m <sup>2</sup> 'ye Düşen Ağırlık				5,604

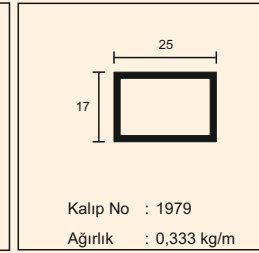
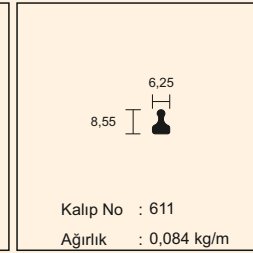
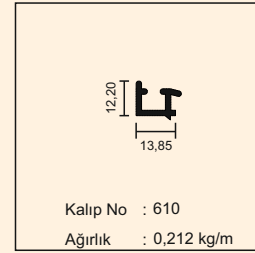
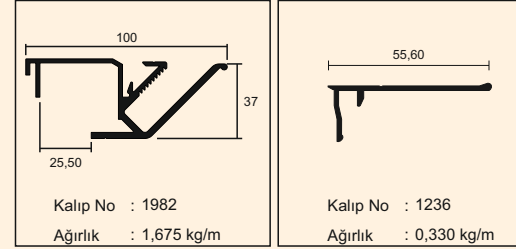
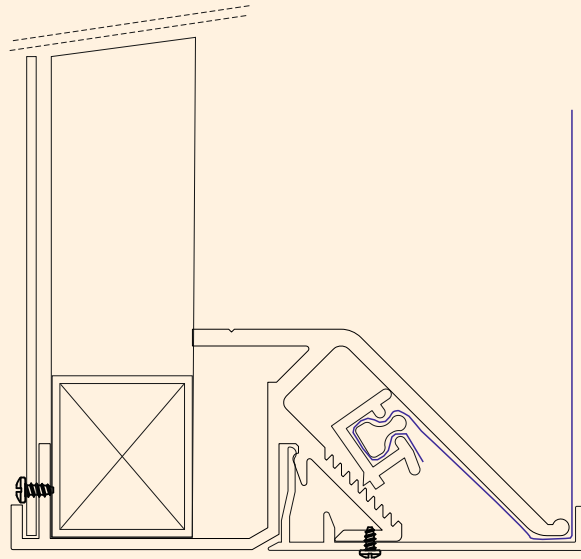
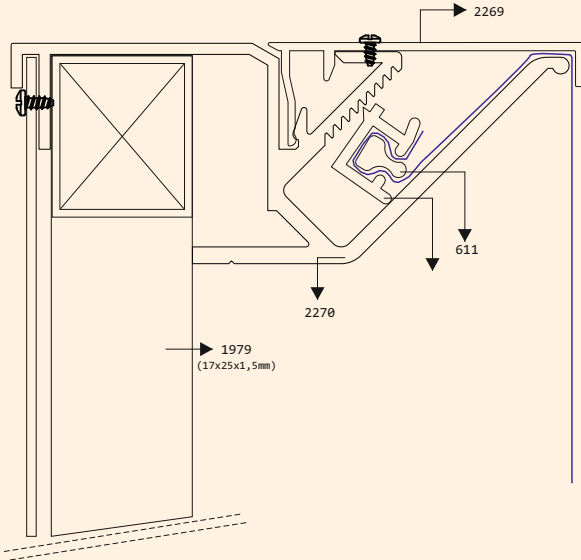

**500 x 100 cm EBADINDA TEK TARAFI IŞIKLI KASA**

Sıra No	Kalıp No	Kullanım Yeri	Miktar (m)	Ağırlık (kg/m)	Toplam Ağırlık (kg)
1	1982	Üst Vinil Germe Kasa	12	1,675	20,100
2	2269	Kapak	12	0,354	4,248
3	610	Klips	6	0,212	1,272
4	611	Klips Çubuğu	12	0,084	1,008
5	1979	17x25 Kutu Profil	12	0,333	3,996
6	Genel Toplam Ağırlık				30,624
7	m <sup>2</sup> 'ye Düşen Ağırlık				6,125



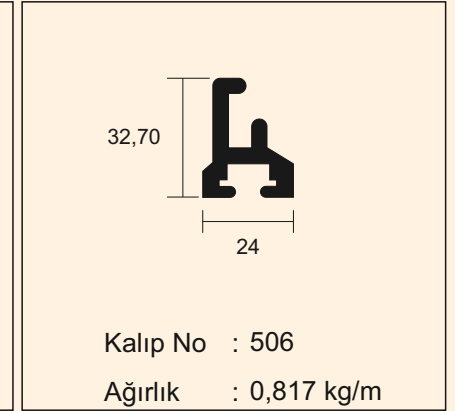
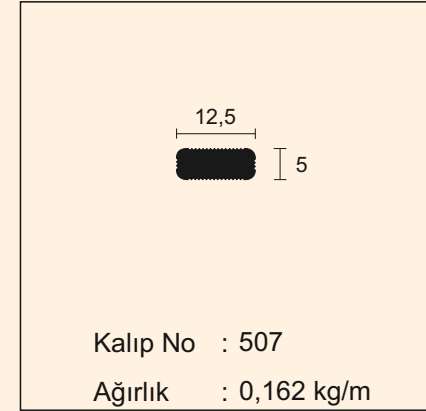
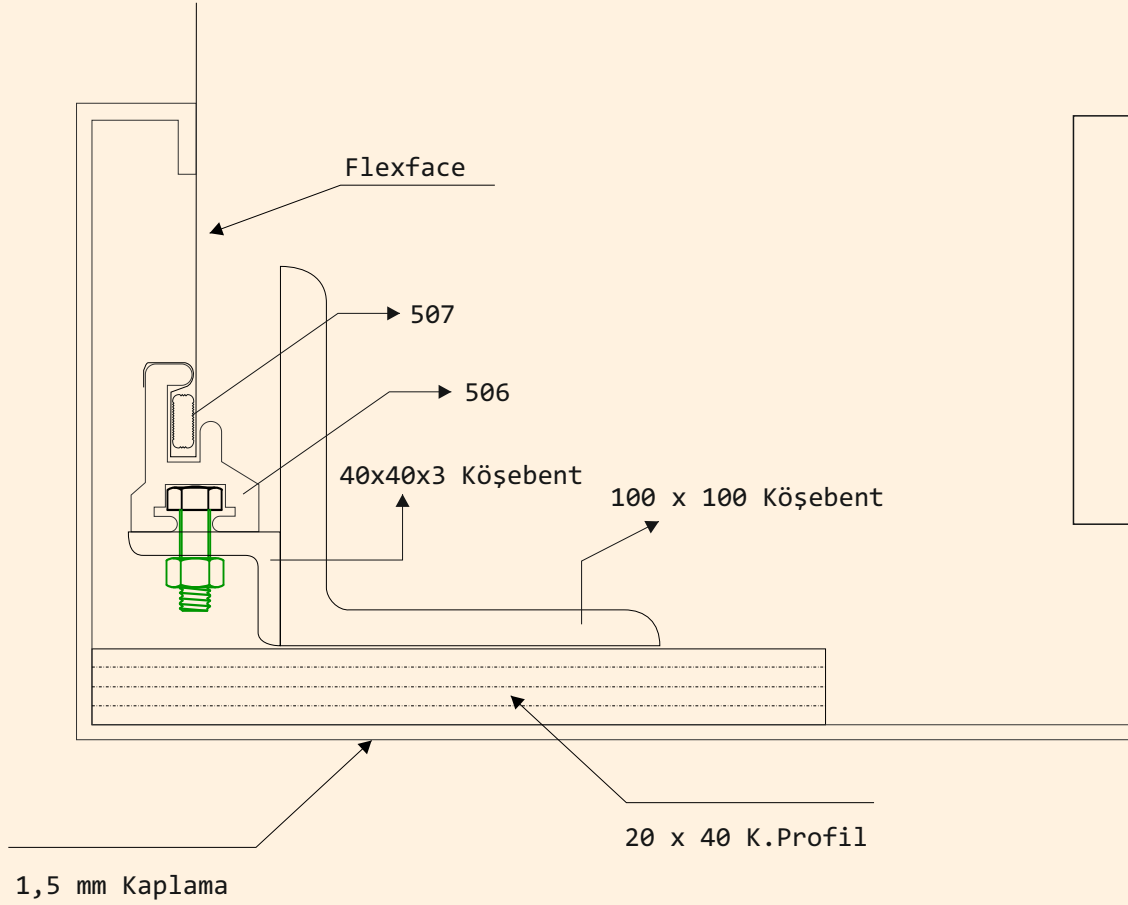

# 690 x 12000 Dev Pano Çalışması Projesi

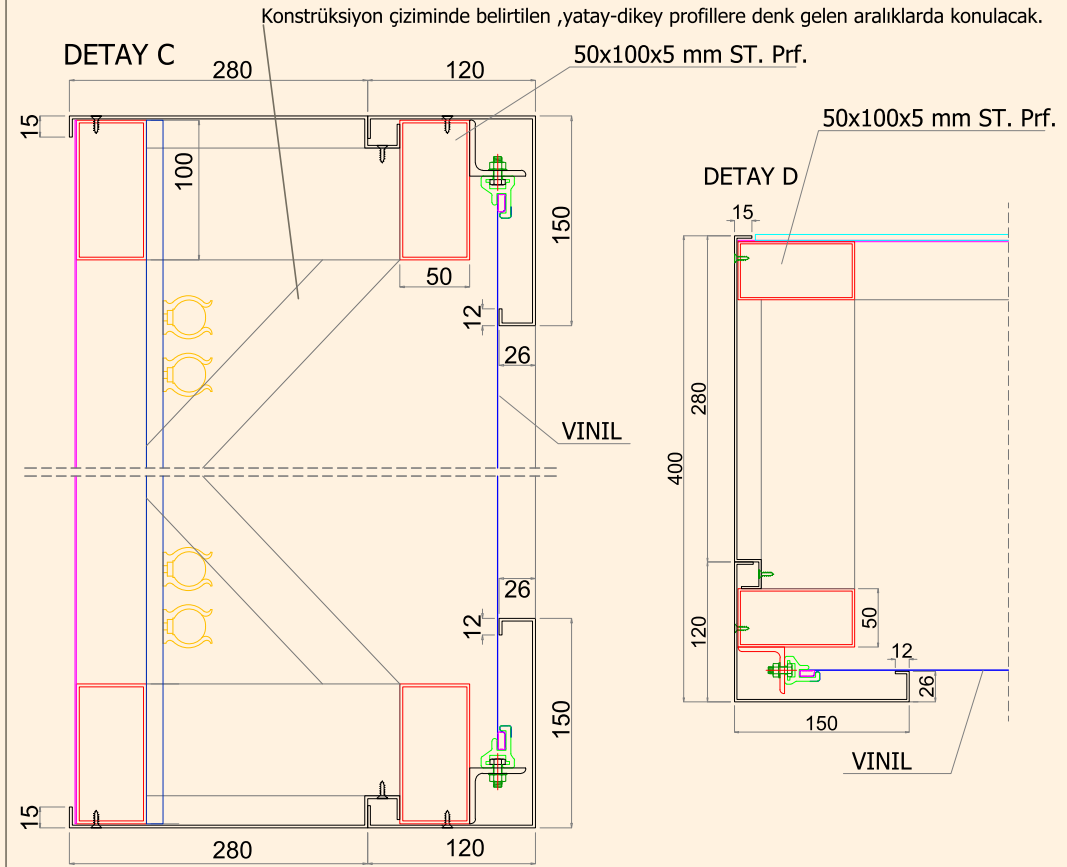
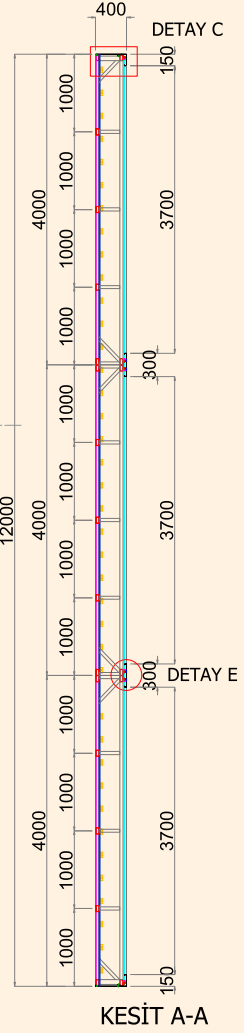
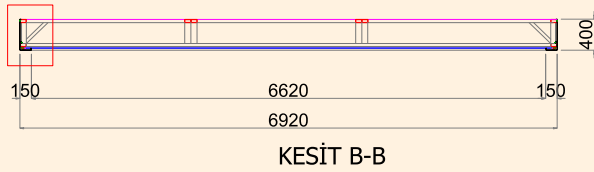
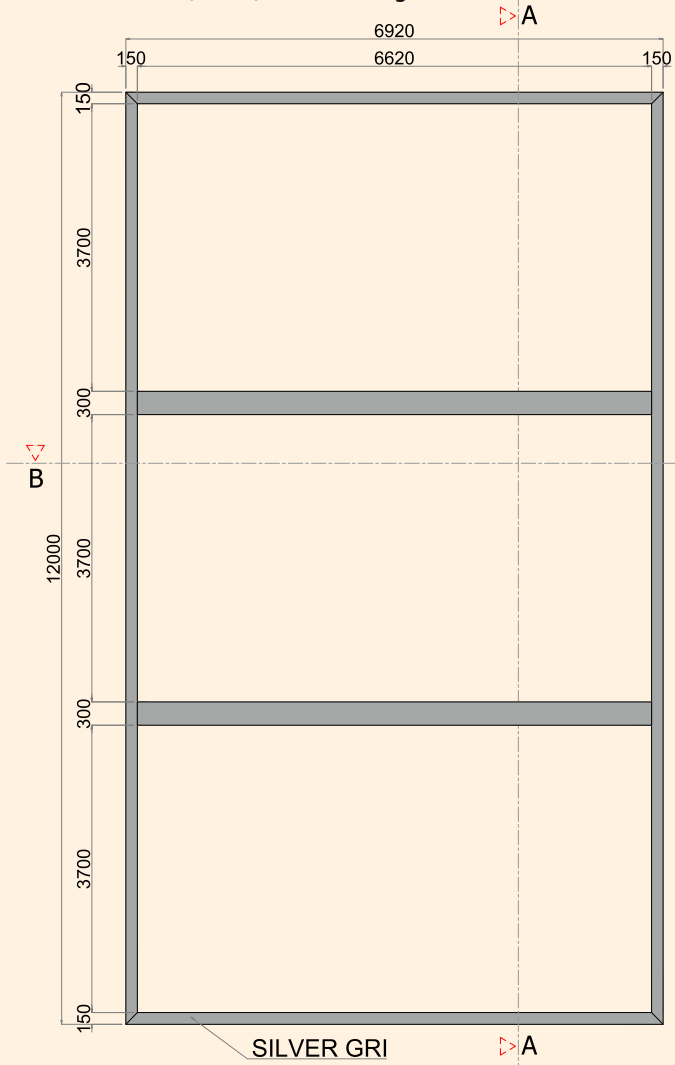

40x40x4 ST mm Köşebent ( Vinil gerdirme klemensleri için )  
110 mm ara ile delikler açılacak.

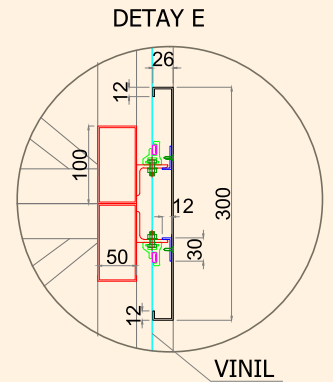

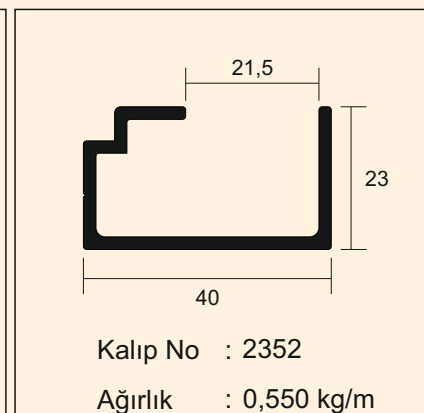
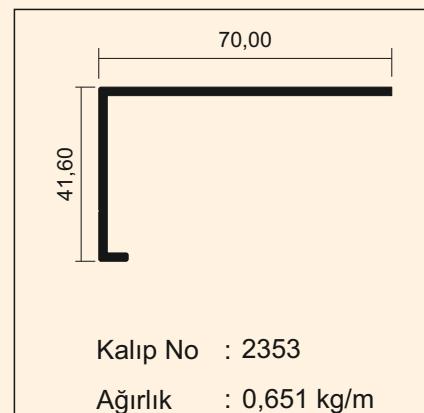
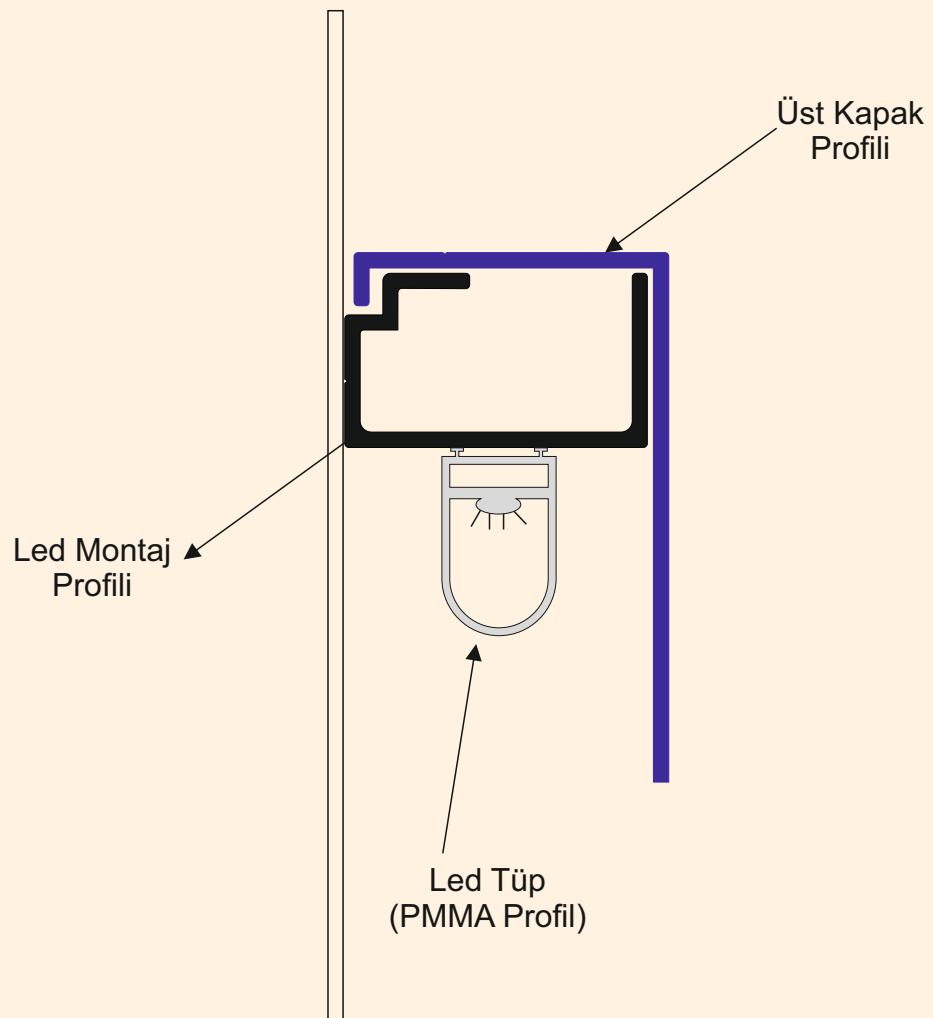

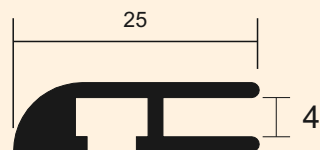
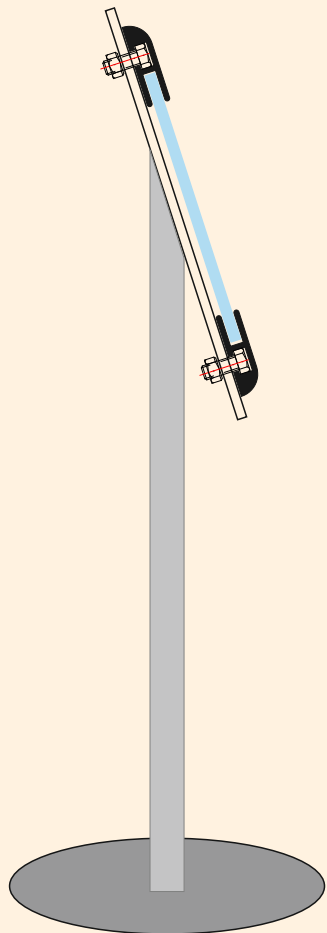

Kalıp No : 1106

Ağırlık : 0,250 kg/m

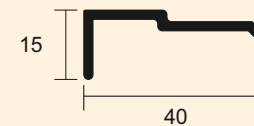
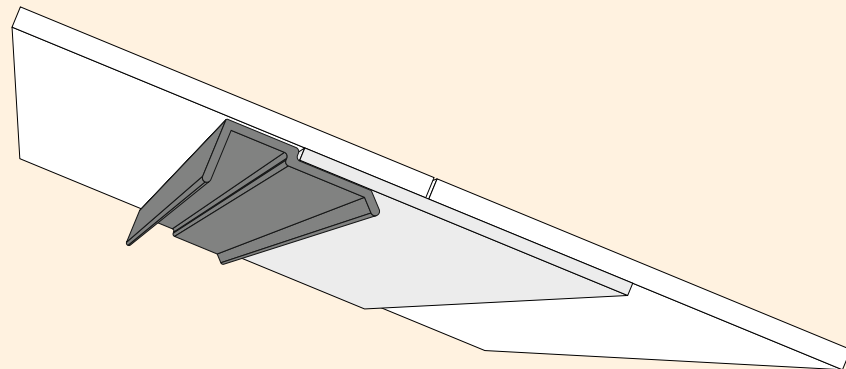

Kalıp No : 1098

Ağırlık : 0,320 kg/m

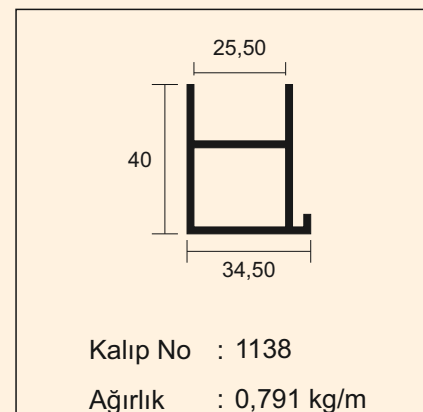
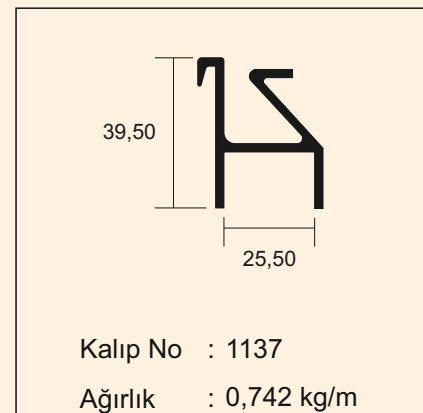
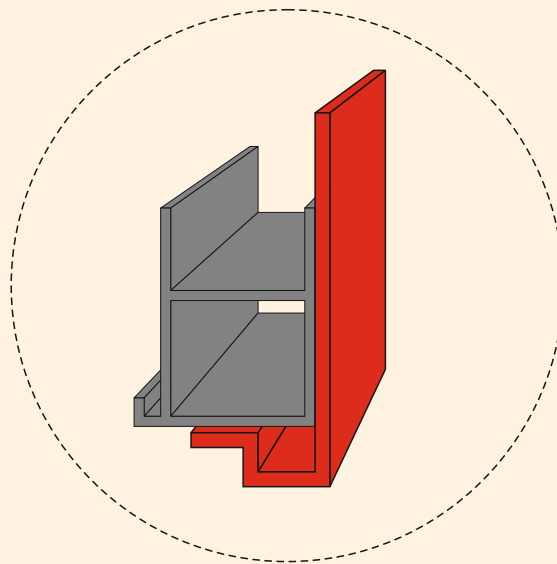
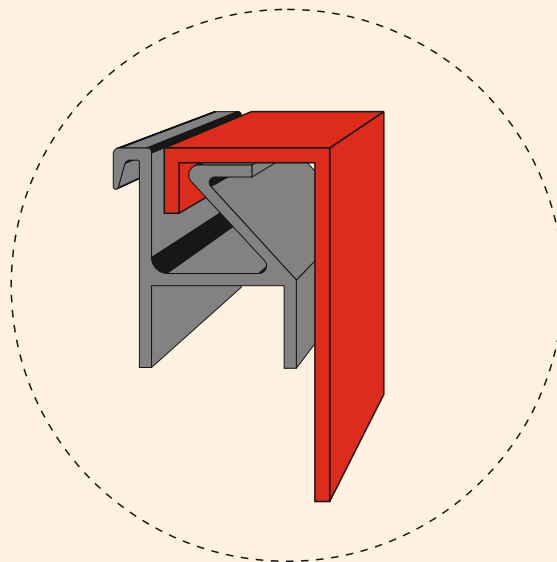
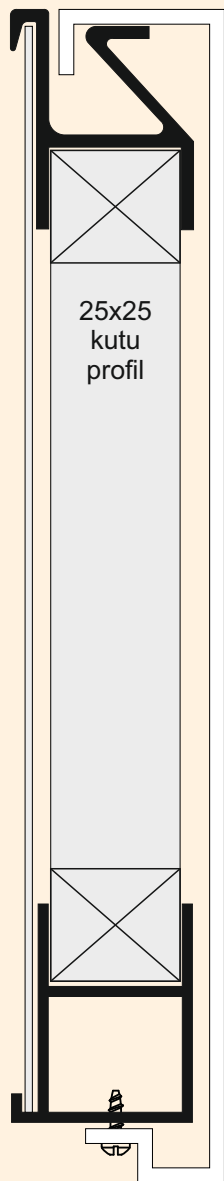

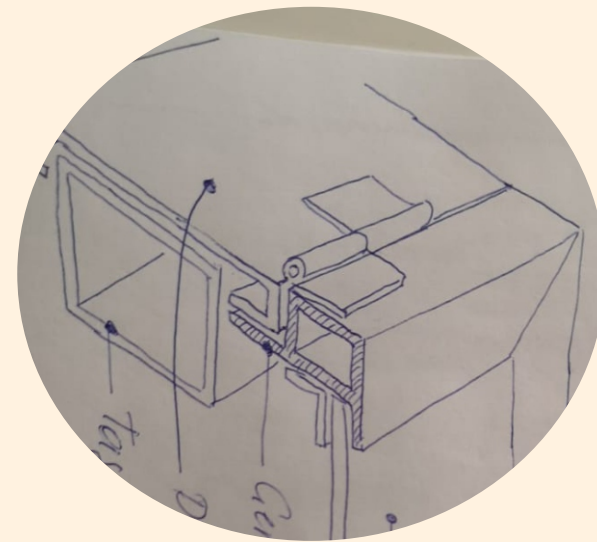
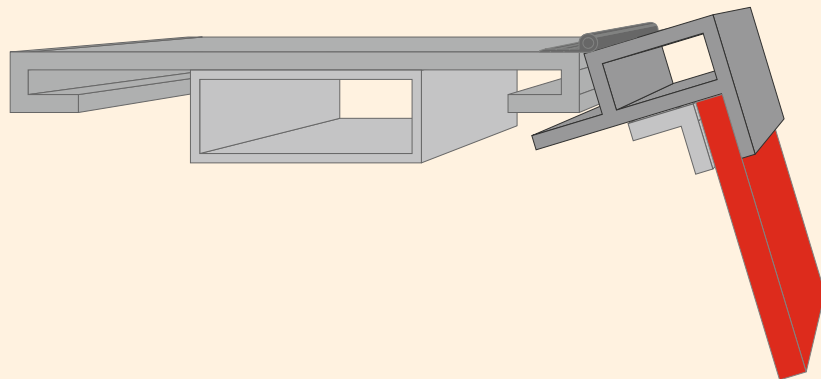
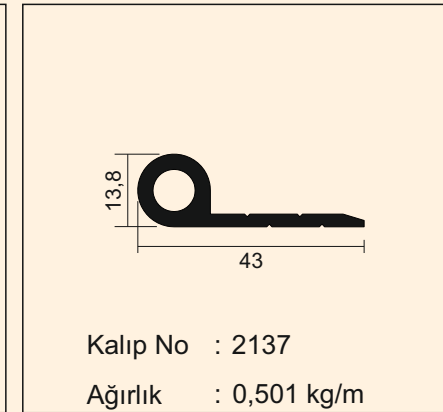
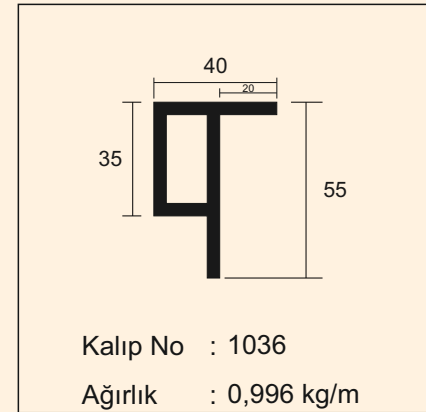
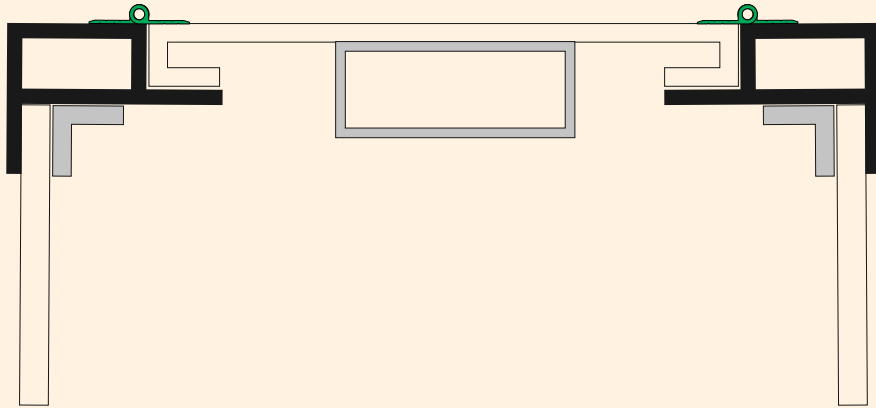

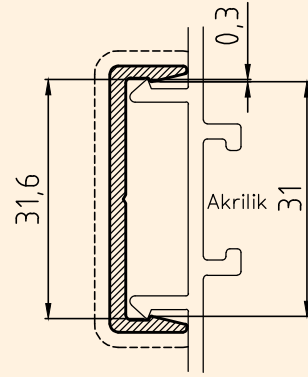
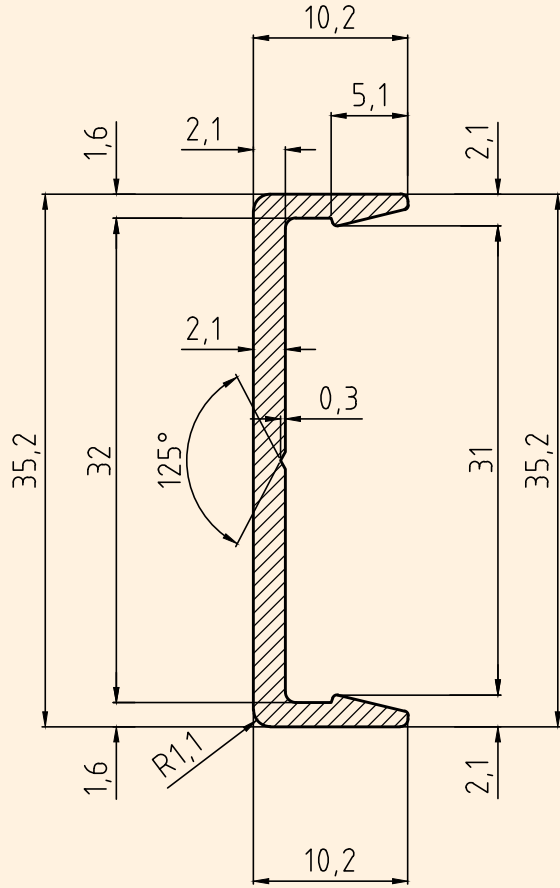

ÖLÇEK: 1/1

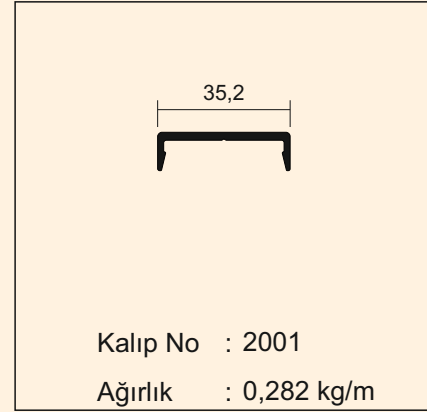

Kalıp No : 2001

Ağırlık : 0,282 kg/m



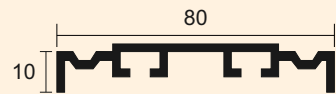
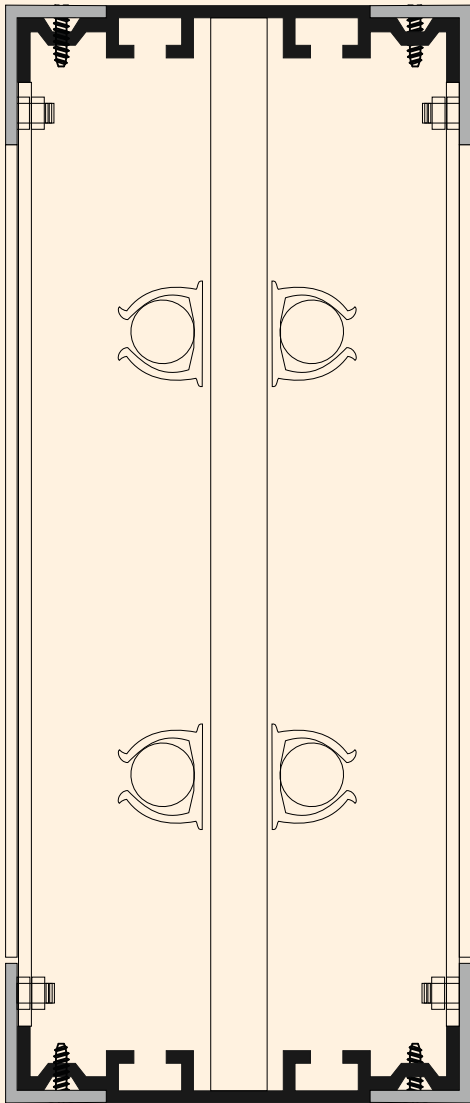

Kalıp No : 1188

Ağırlık : 0,786 kg/m

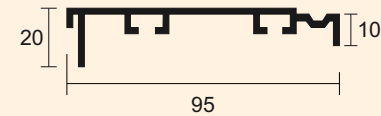
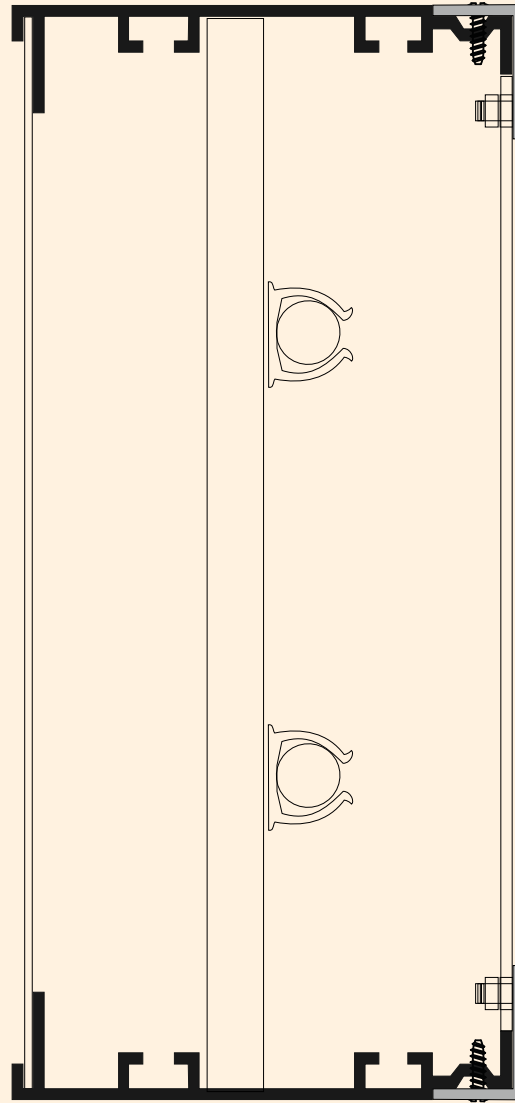

Kalıp No : 1187

Ağırlık : 0,933 kg/m



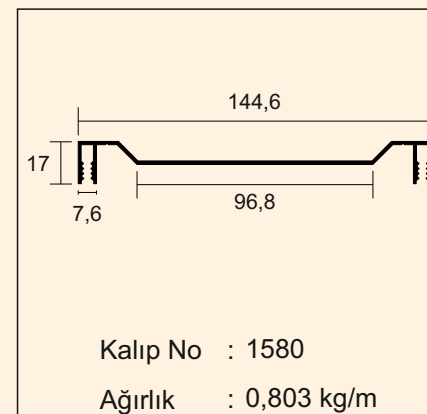
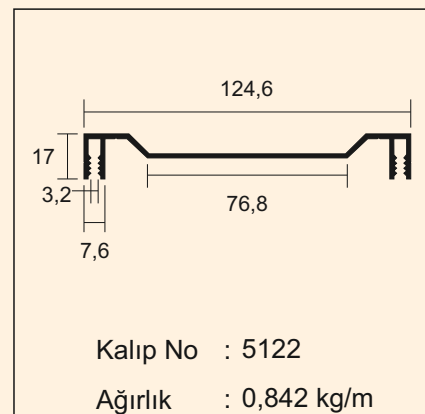
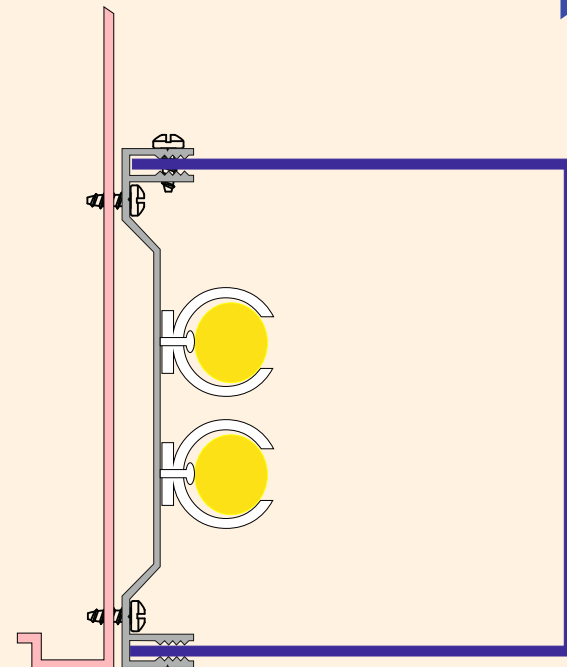
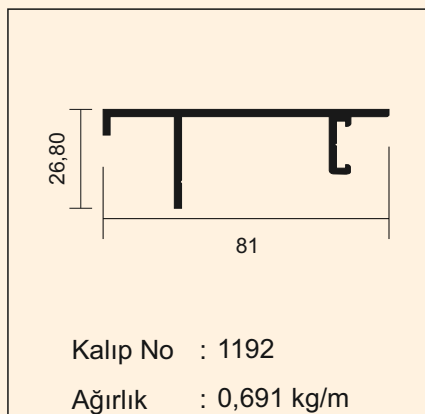
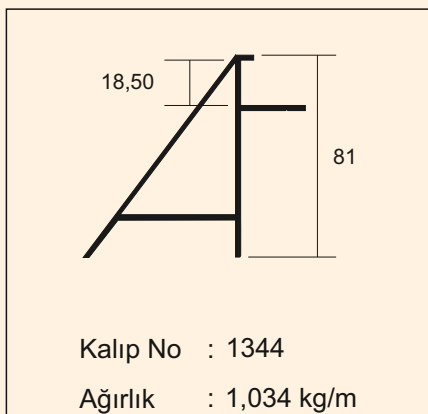
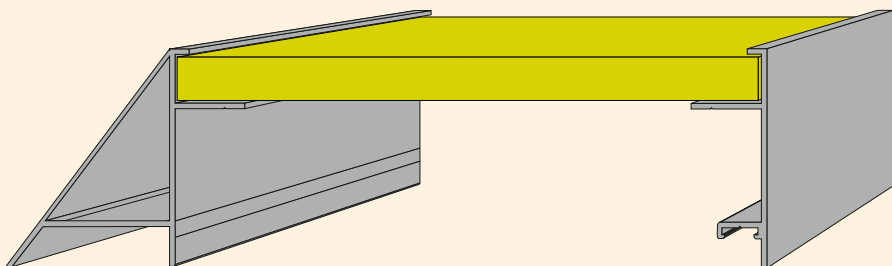

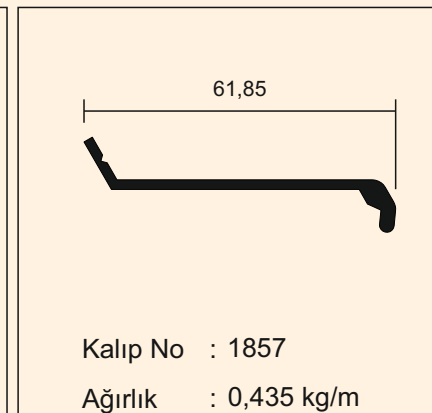
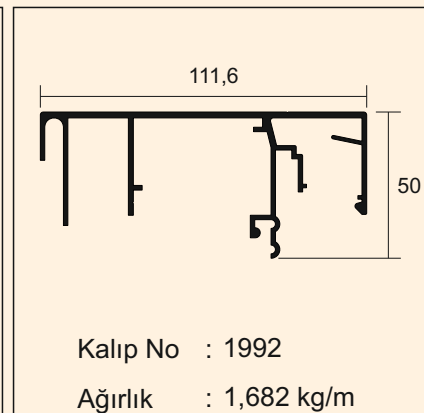
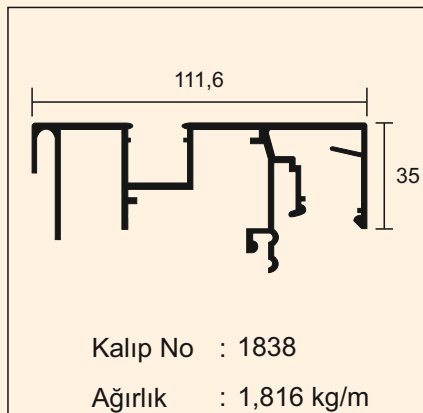
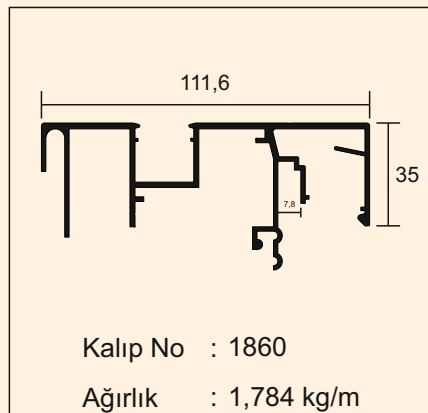
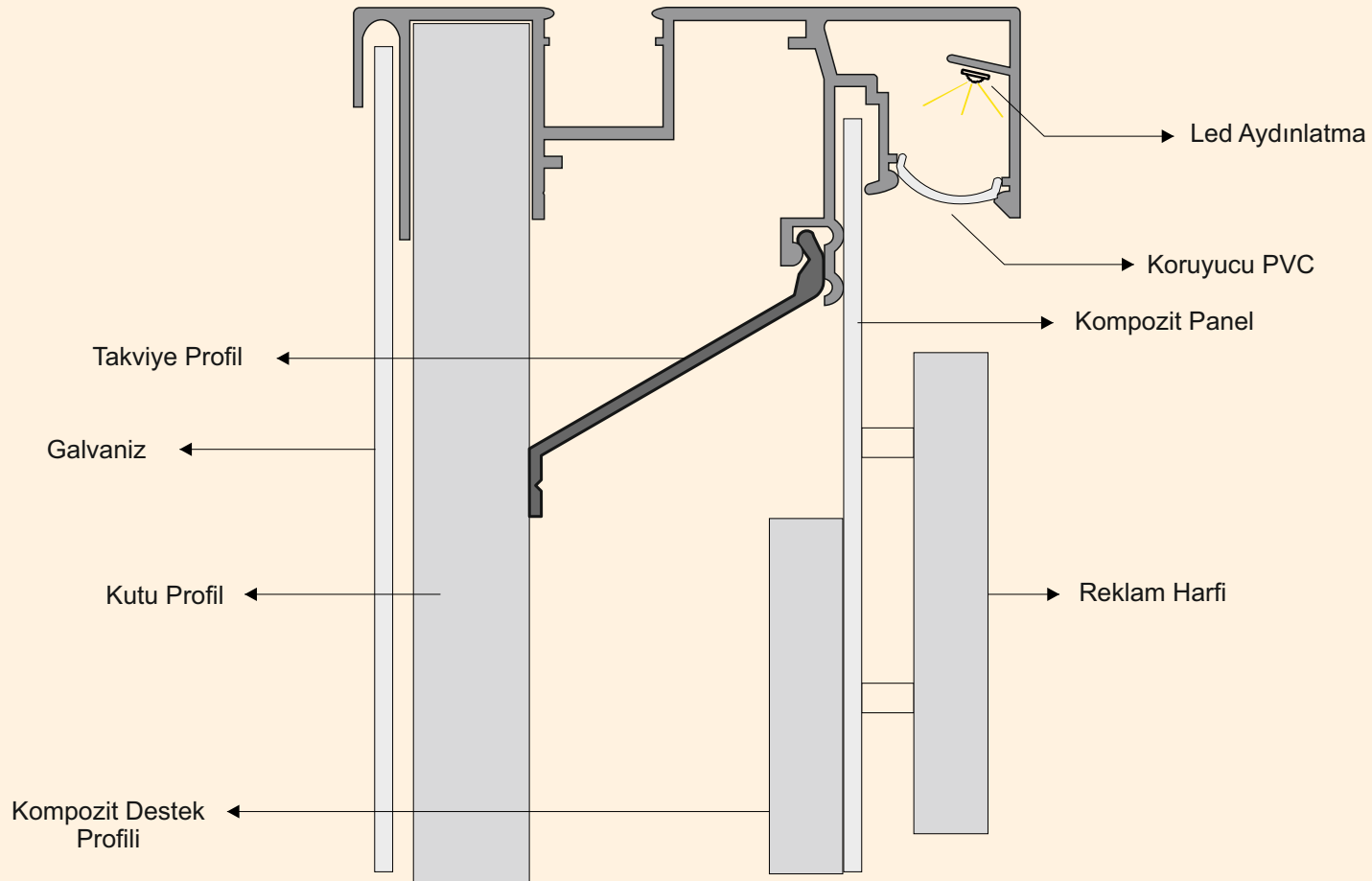

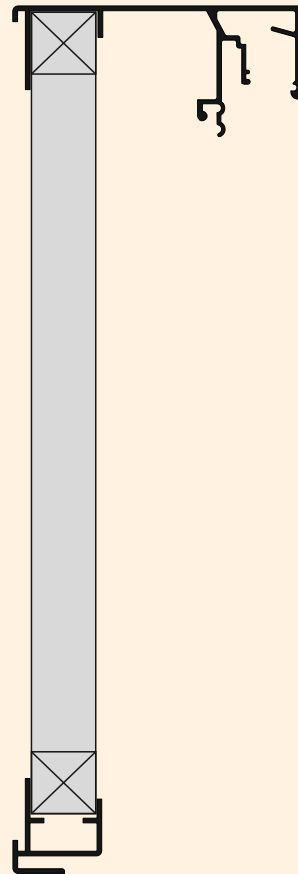
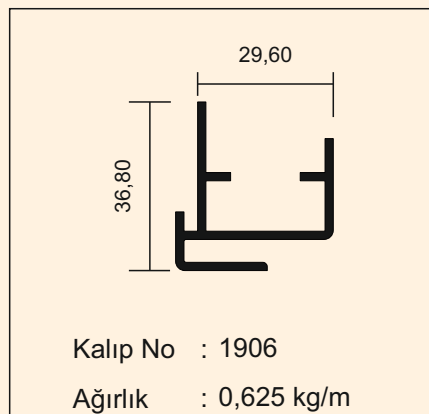
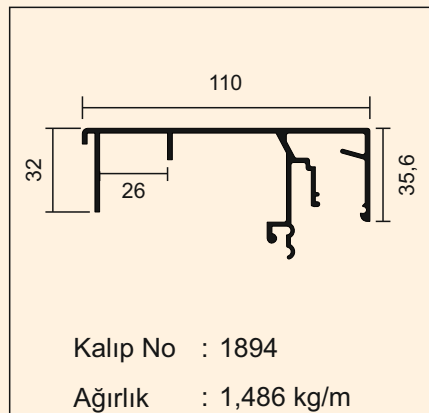

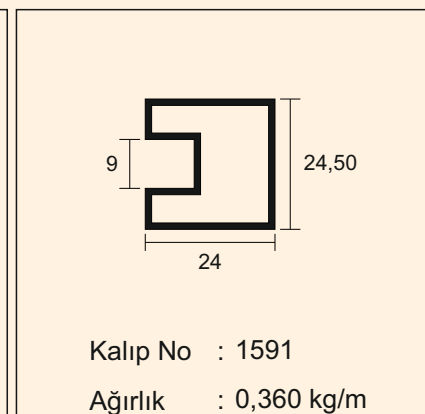
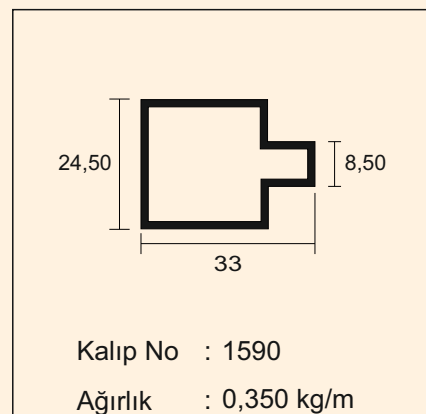
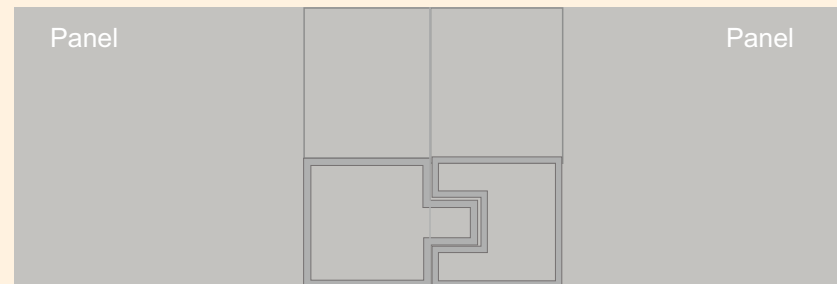
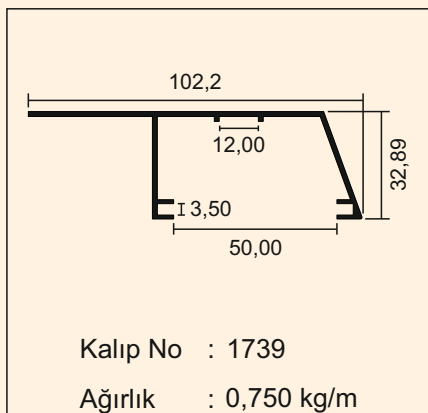
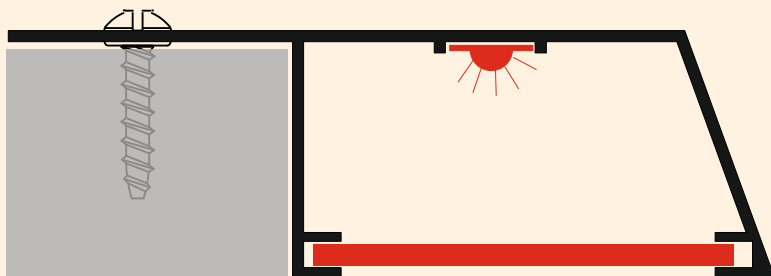

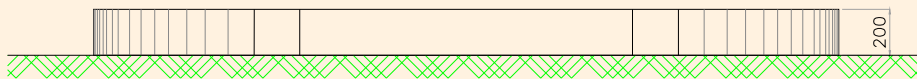
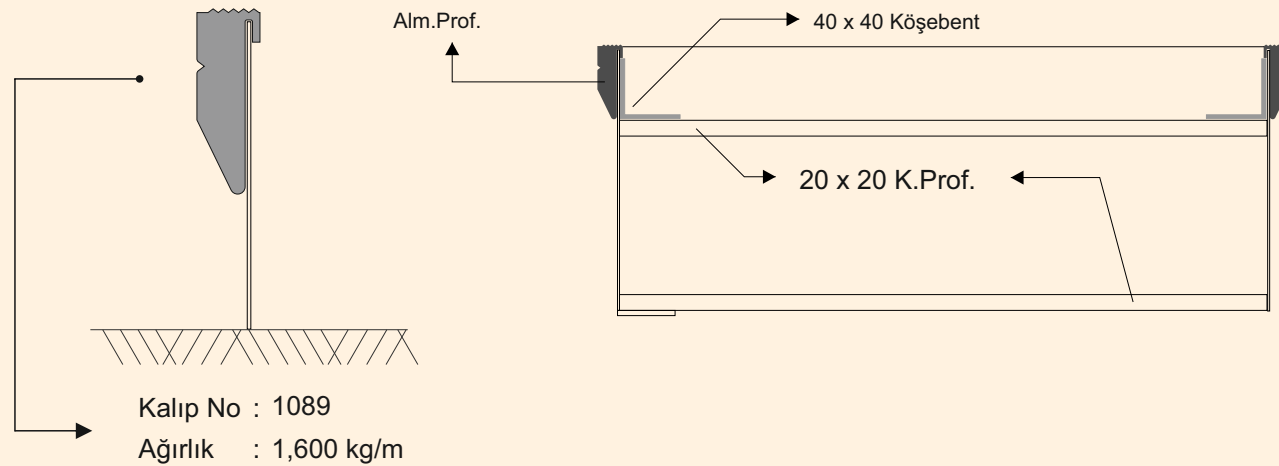

GÖRÜNÜŞ

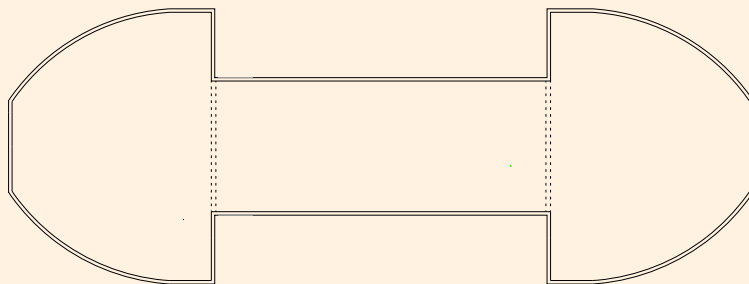

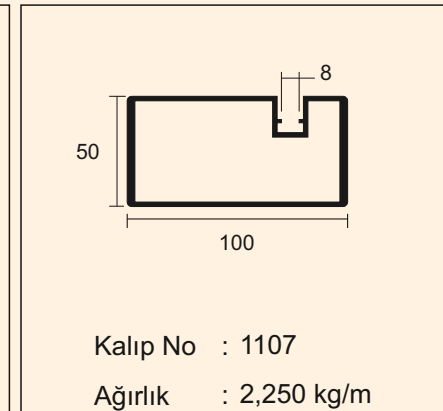
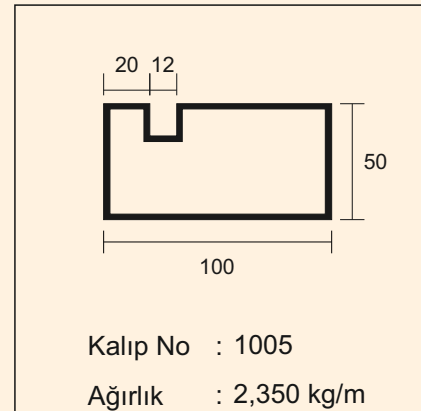
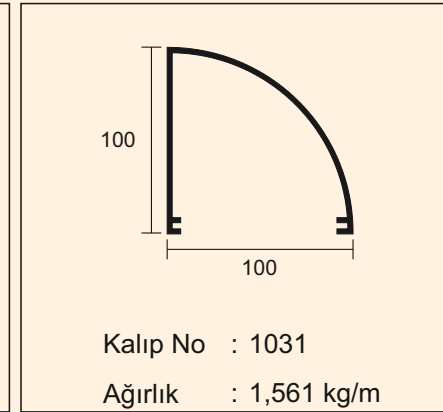
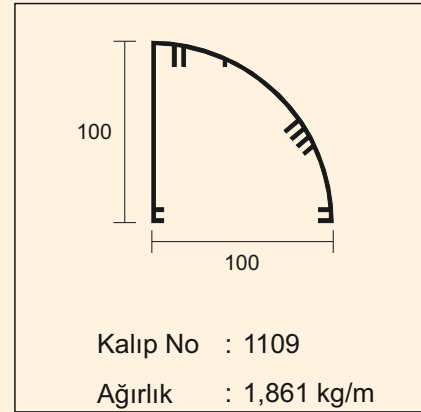
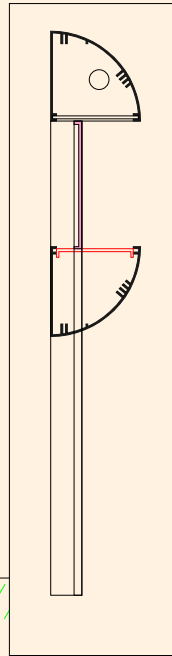
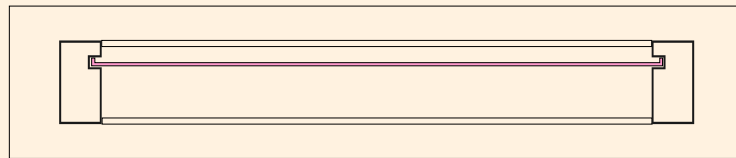
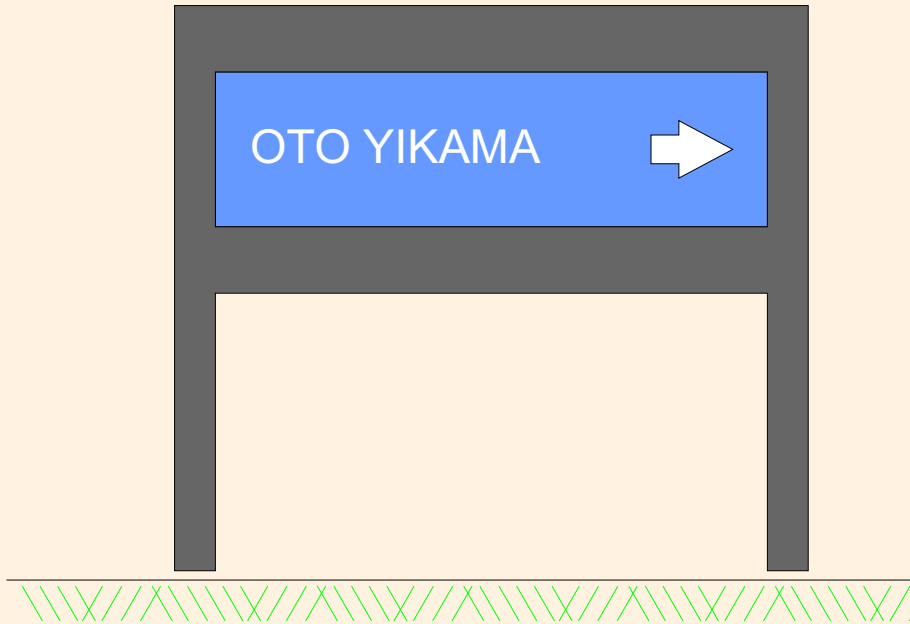

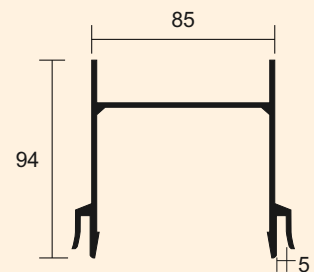
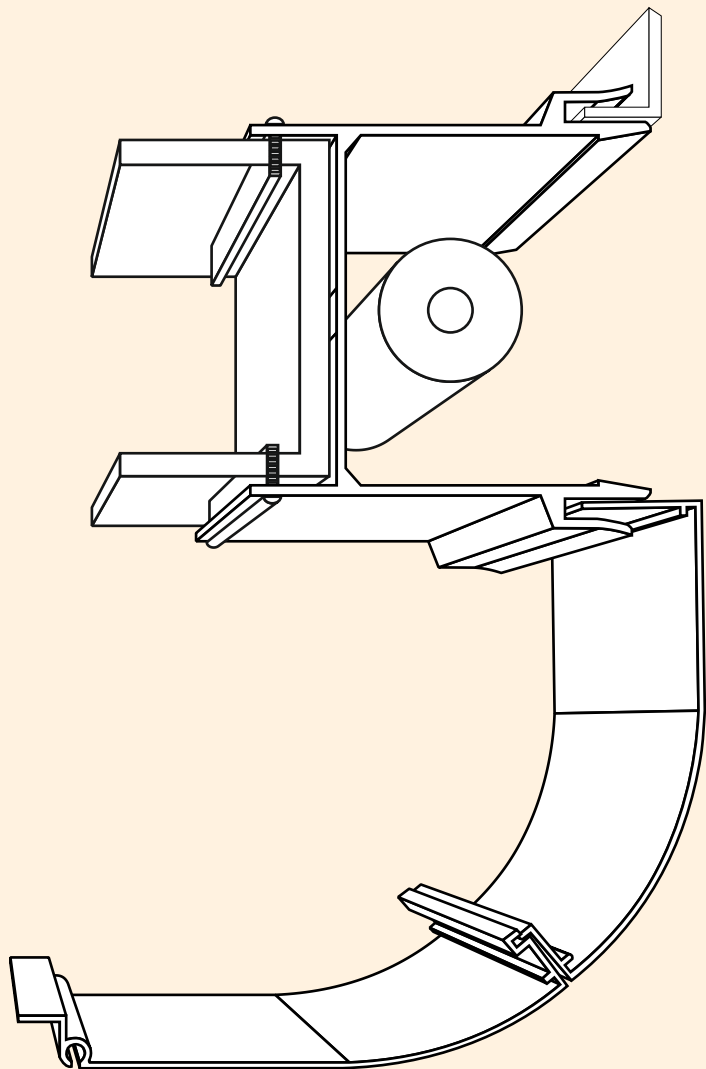

Kalıp No : 1199  
Ağırlık : 1,975 kg/m

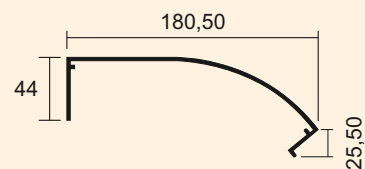

Kalıp No : 1200  
Ağırlık : 1,480 kg/m

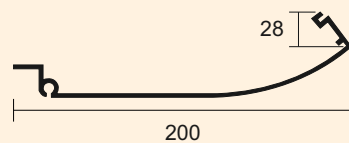

Kalıp No : 1201  
Ağırlık : 1,559 kg/m



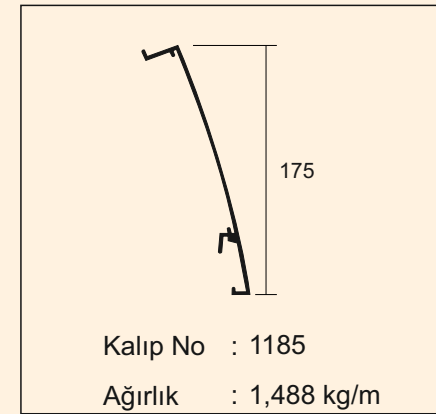
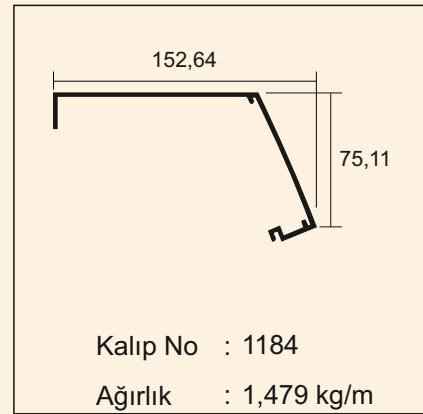
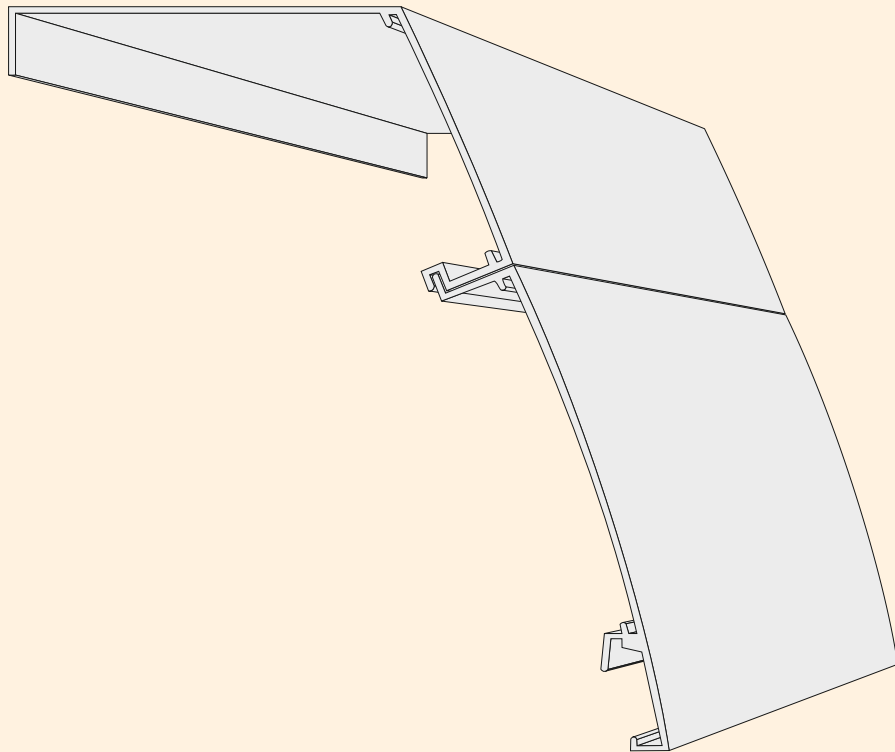



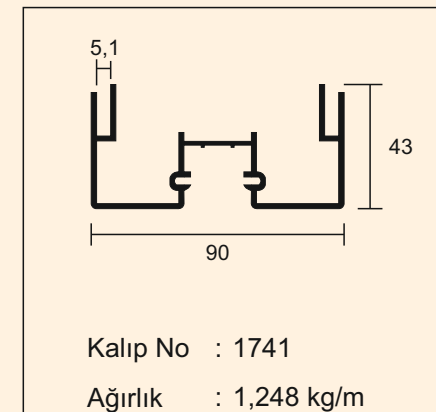
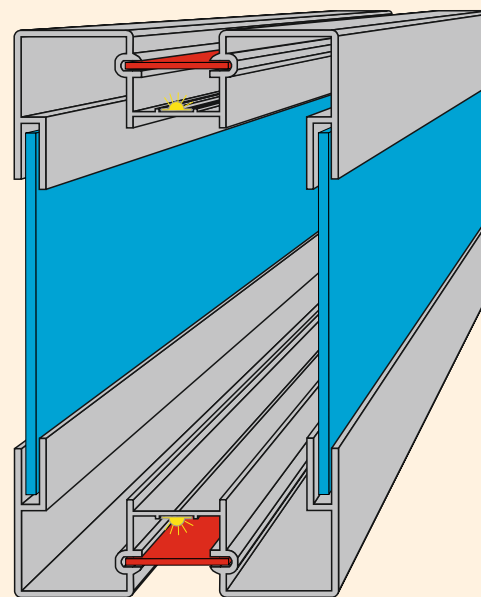
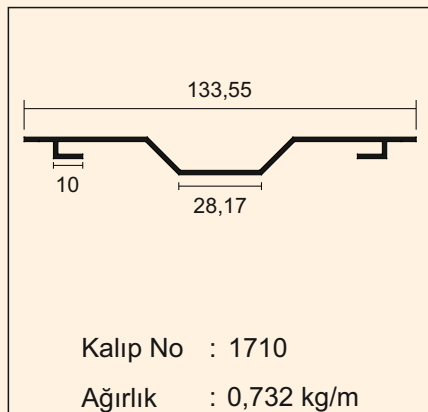
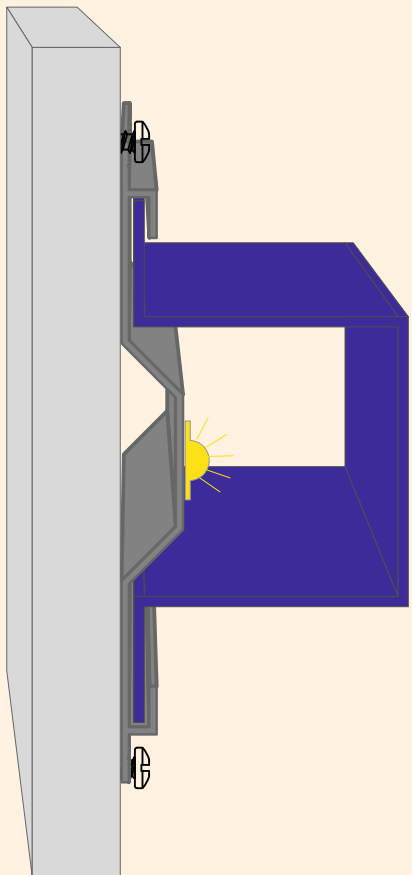

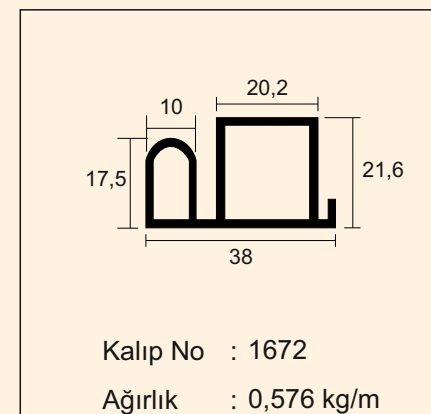
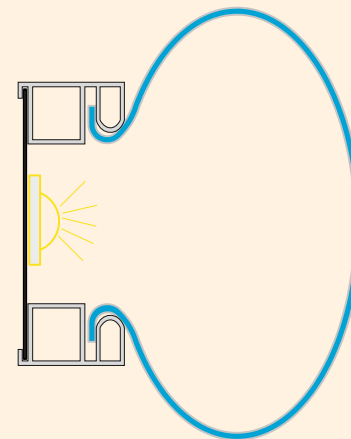
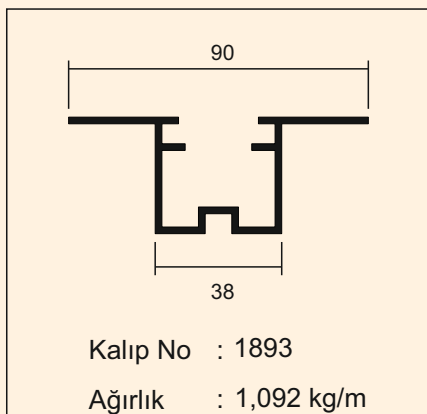
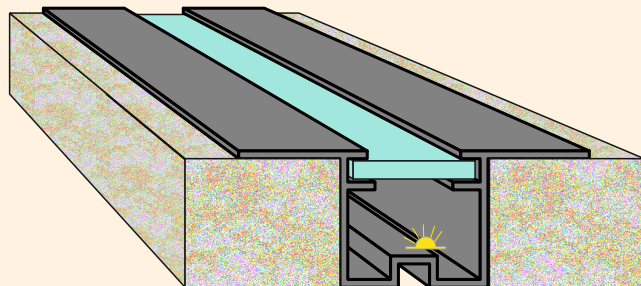

### Tek taraflı ürün profilleri

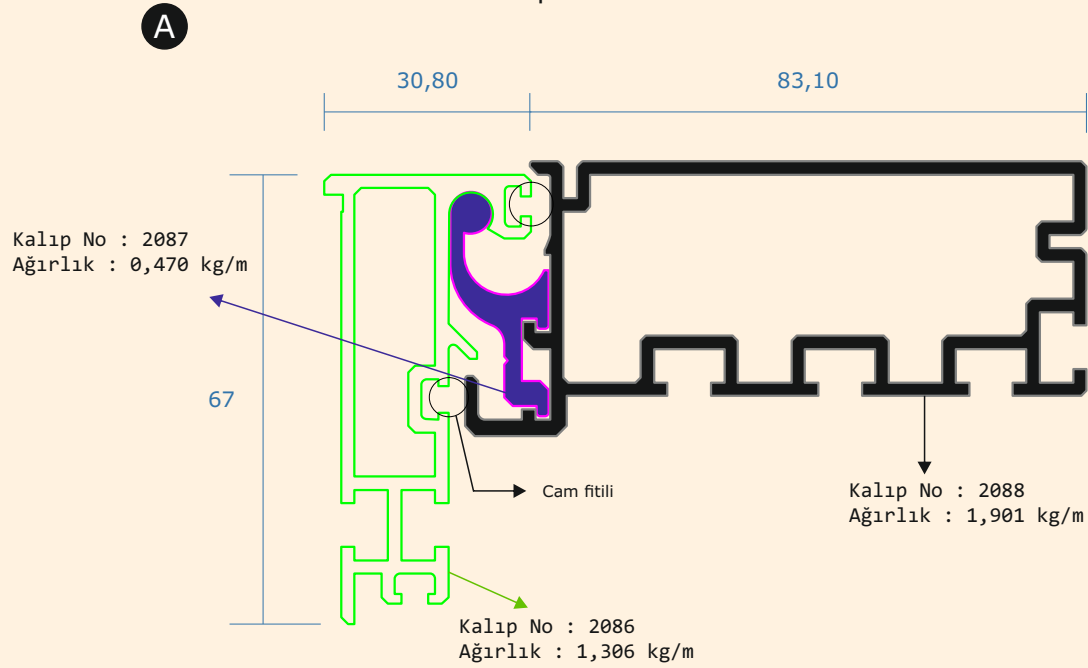

### Çift taraflı ürün profilleri

